

# M-Policy

2024



Plug-in  
Signal  
Conditioner  
Released  
in 1973

Plug-in  
Signal  
Conditioner  
of the Latest  
Design

**We do not easily stop manufacturing products once released in the market and continue to make same product available**

■ Introduction .....	Page 2
■ One-Piece-At-a-Time production system - I (production process) .....	Page 4
■ One-Piece-At-a-Time production system - II (introduction of production plan and production line) .....	Page 6
■ Product development system .....	Page 8
■ Customer Center .....	Page 10
■ Our production system which continues to make same product available .....	Page 12
■ Special specifications without additional charge .....	Page 14
■ Strong emphasis on quality assurance system .....	Page 16
■ Introduction of Kyoto Research Center & Factory .....	Page 18

MG CO., LTD.  
(formerly M-System Co., Ltd.)  
[www.mgco.jp](http://www.mgco.jp)

Make Greener automation

# “We try everyth

We are a comprehensive manufacturer  
We strive to do everything we can



Multi-Function PID Controller



Remote I/O



Signal Conditioners



Digital Panel Meters

## Our Missions ...

→ High-mix, Low-volume, Short lead time

→ Make-to-order system to manufacture products one by one

**Details** One-Piece-At-a-Time production system

**Page 4**

→ All sales are through our authorized distributors.

→ Strong emphasis on quality assurance system

**Details** Strong emphasis on quality assurance system

**Page 16**

→ We try to conform our products to international standards.

# ing as possible”

of the instrumentation components.  
to solve our customers’ problems.



**Quick Service Center** expedites orders on the same day or next day after ordered for our customers’ urgent needs.

## Our Five Policies

### 1. Continued Products Availability

**Details** ▶ The production system which we don’t easily discontinue the production of product

**Page 12**

### 2. Fast and Precise Delivery

**Details** ▶ Customer Center

**Page 10**

### 3. Special Specifications Service

**Details** ▶ Special specifications without additional charge

**Page 14**

### 4. Special Repair Service

**Details** ▶ Special Repair Service

**Page 17**

### 5. Factory Setting Service with No Extra Charge

**Details** ▶ Introducing the high-mix, low-volume production line (calibration/inspection/configuration)

**Page 7**



## From receiving an order to delivery

High-mix, low-volume production system

# One-Piece-At-a-Time Production System

## I

(Production process)

We use the production master server to manage necessary information for the make-to-order system and manufacture the products one by one in order to realize the high-mix, low-volume production in short lead times.

Here we introduce our own production process where we manufacture products with different specifications one by one while using chip mounters usually suitable for mass production.

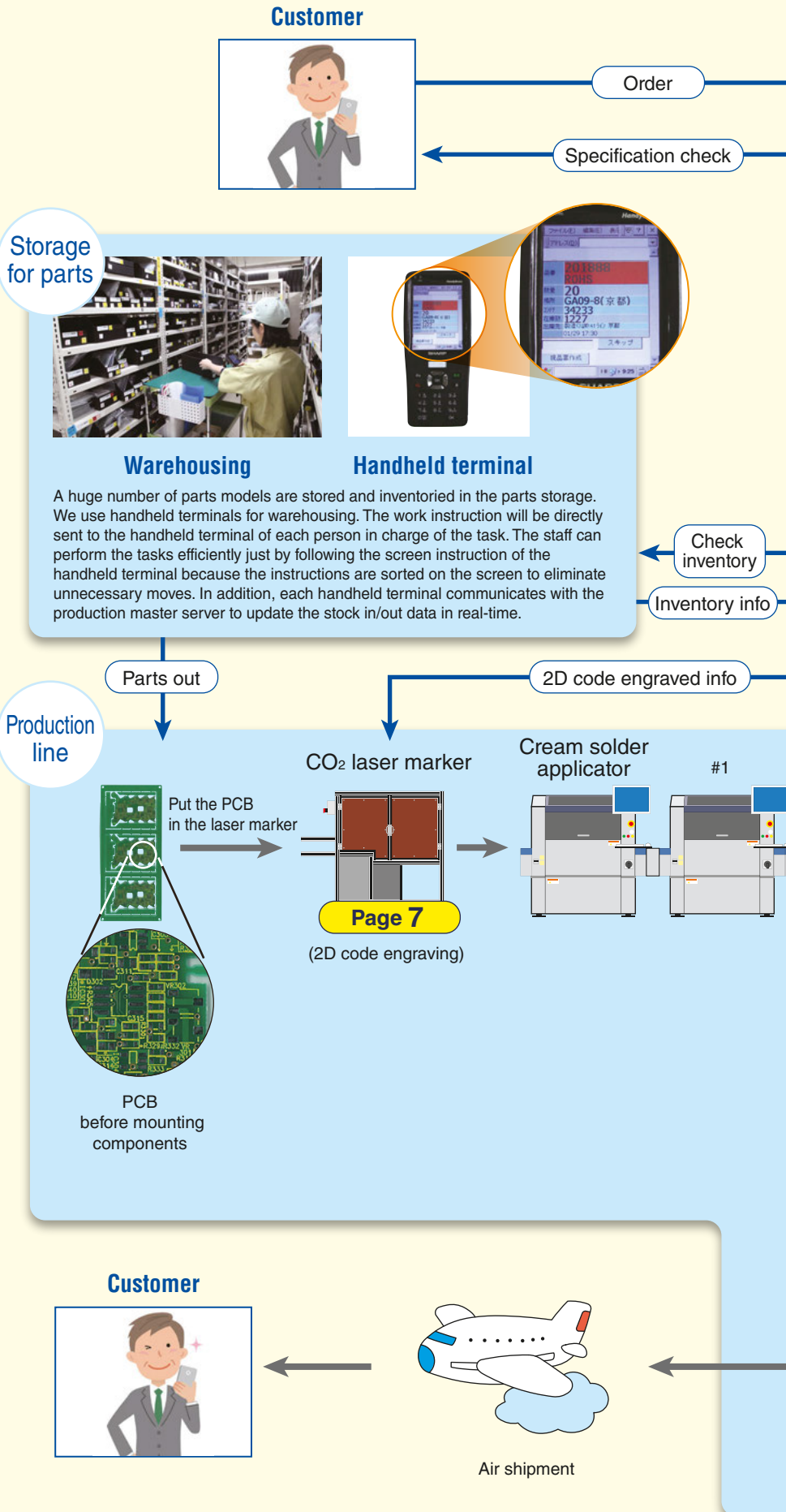

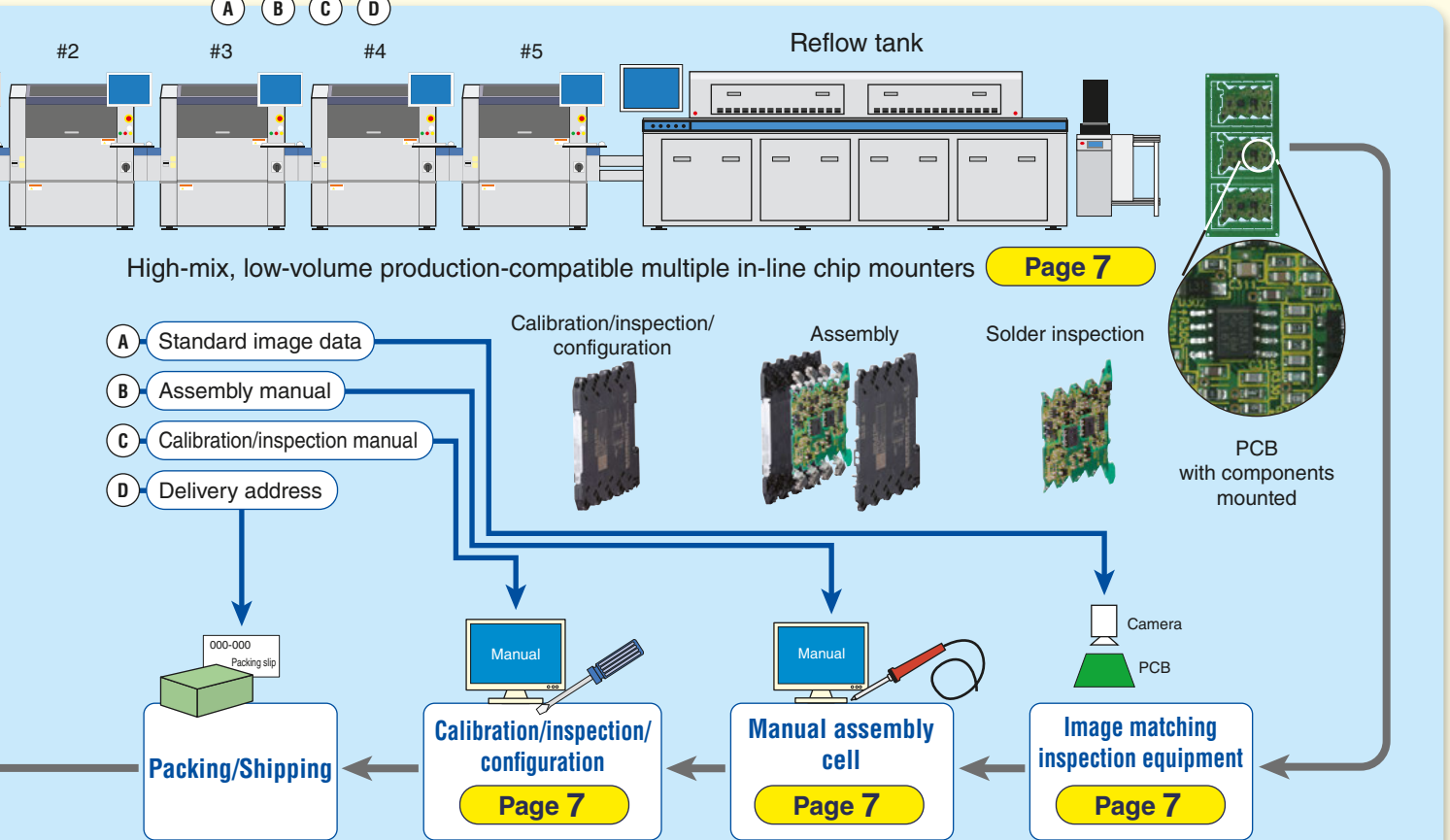
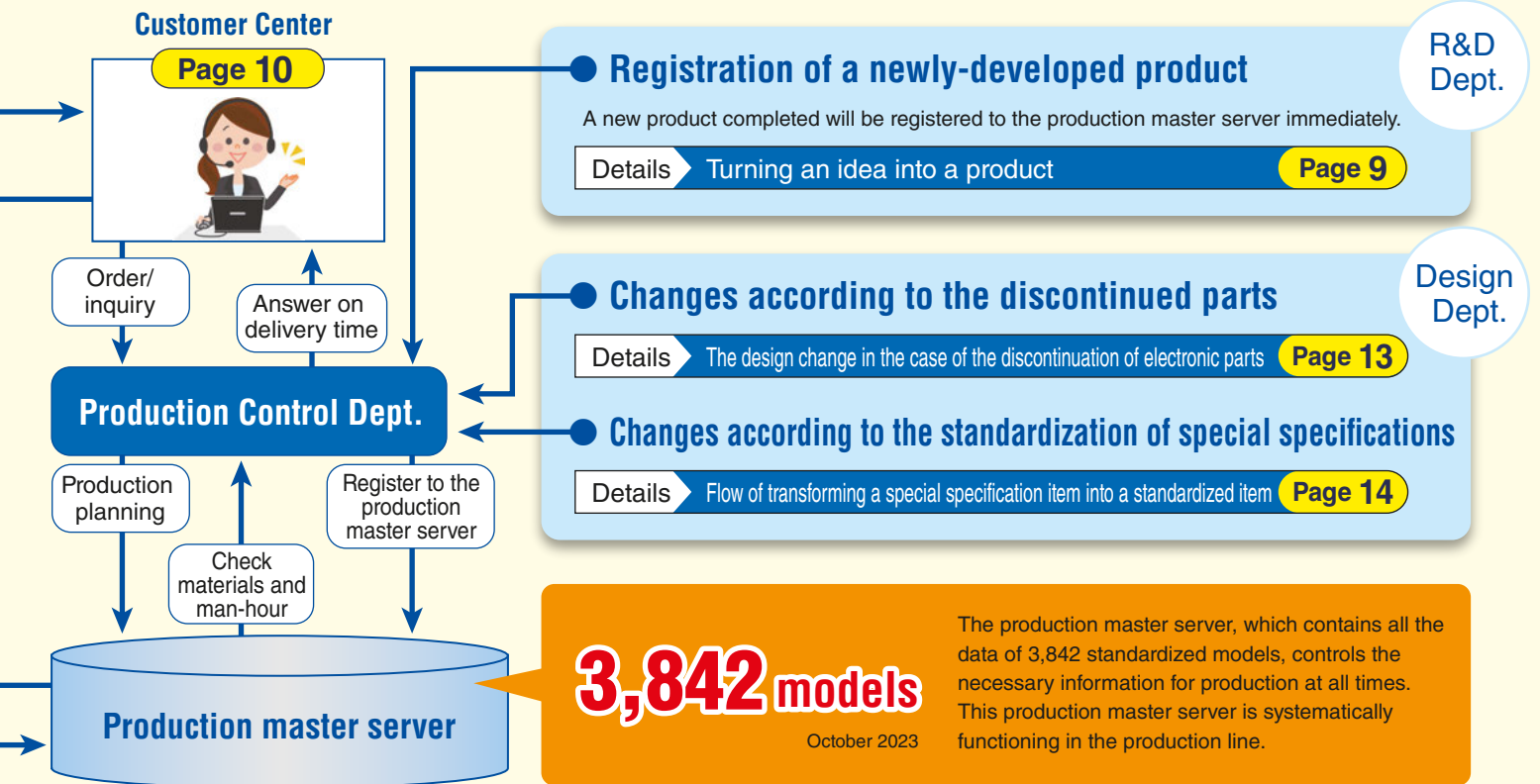

We use the production master server to control the entire process from receiving an order to shipping a product. In our production line, first we engrave 2D code on a printed circuit board, then we download data from the production master server based on the 2D code in each stage of parts assembly, inspection, and calibration.

## Statistics on our storage for parts

The number of parts models in stock

**16,676** models

The number of parts used per month

Approx. **14,932,000** pieces

Total number of parts in stock

Approx. **154,317,000** pieces

If the parts supply stops under an emergency situation, the production can continue for

**7 to 8** months

High-mix, low-volume production system

# One-Piece-At-a-Time Production System

## II

( Introduction of production plan and production line )

See Page 6 for details on the production plan and Page 7 for the individual production line.

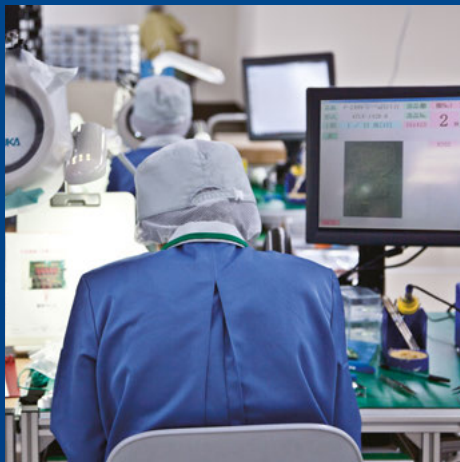

## Orders and production plan processed in real-time

### How the production plan is being filled

The current order status and how they are reflected to the production line are always on the monitor so that the Production Control Dept. can see the latest status at a glance. The bar graphs below show the changes of the daily order status and their reflection to the production line of signal conditioners by sampling data in the morning, afternoon, and evening respectively. You can see how fast we process the orders received and complete the production while leaving enough room for 2 days later and thereafter.

Morning 9:00

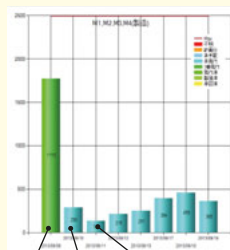

Today Next day 2 days later

Starting the production on the next day or later is less common compared to the same day.

Daytime 13:00

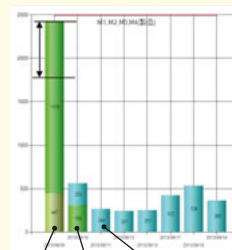

Today Next day 2 days later

Some are already on the production in the morning of the same day. More products completed the production and ready for shipping on the same day.

Evening 16:00

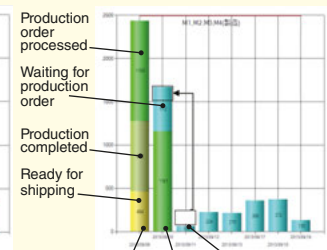

Today Next day 2 days later

The production order for the next day is issued the most during this time frame. We often move up the calibration schedule one day for some products.



# Introducing our high-mix, low-volume production line

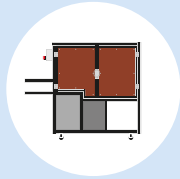

**CO<sub>2</sub> laser marker**

In the beginning of the production process, we engrave 2D code containing the information including product model, serial number (SER NO.) and the combination information onto each PCB. These 2D codes will be scanned in each process of the production process to download necessary information from the production master server.



CO<sub>2</sub> laser marker

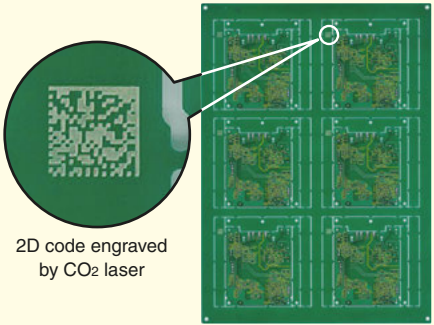

2D code engraved by CO<sub>2</sub> laser

PCB for the high-mix, low-volume production

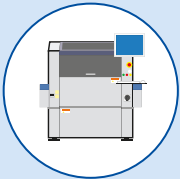

**High-mix, low-volume production-compatible multiple in-line chip mounters**

We utilize the multiple in-line chip mounters compatible with the high-mix, low-volume production, which allows for automated implementation of products with different input, output, and power specifications. In this process, the production master server instantly selects the implementation program based on the 2D code data scanned.

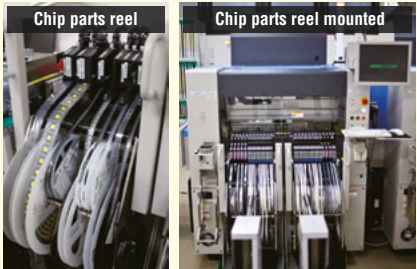

Set approximately 350 types of parts in a wagon at the same time and produce different products without changing the setup.

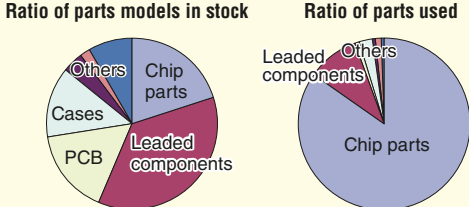

Approximately 20% of the electronic parts in stock are the surface mounting (chip) parts. Approximately 90% of the parts used are the surface mounting (chip) parts. (For example, a typical signal conditioner has approximately 180 pieces in 80 different models of the surface mounting parts.)

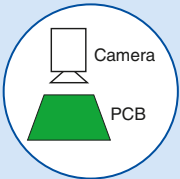

**Image matching inspection equipment**

Download the standard images of the printed circuit board from the production master server based on the 2D code data scanned. Check them against the inspection images to make a pass/fail decision.

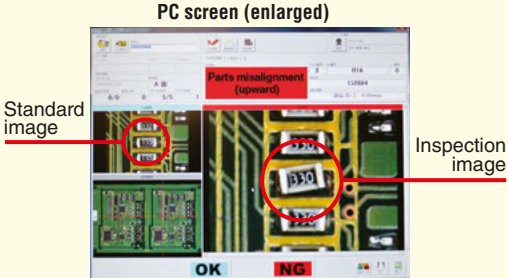
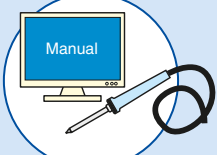



**Manual assembly cell**

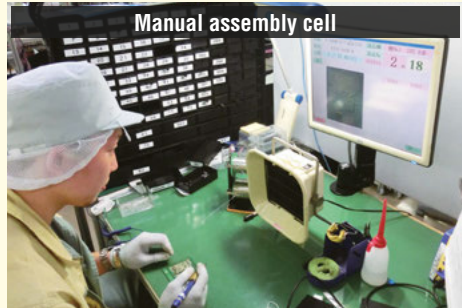

**Calibration/inspection/configuration**

We begin the process of manual cell assembly, calibration, and inspection by downloading manuals from the production master server based on the 2D codes scanned. We provide free configuration services for the necessary products prior to shipping if requested from the customer on the order.



We do not easily stop manufacturing products once released in the market and

## Statistics on our R&D Dept.

# Product Development System

We have been engaged in the development of products featuring the analog circuit technology accumulated over 50 years.

Combining our own kind of analog technology and the latest digital circuit technology, we continue to supply new products at reasonable price, which are convenient to use and meet market demand.



DL8 Series use the smartphone for the display and transmit data measured at worksite via wireless LAN or internet.



## New model production starts every 6 days

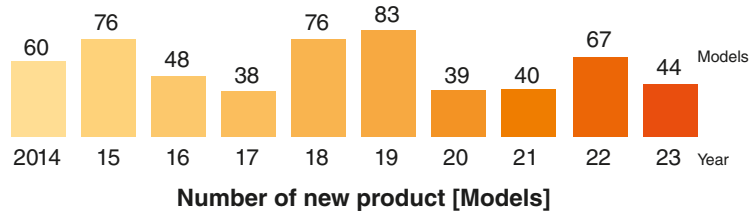

## System to create new products as quickly as possible

**Development period** = About 6 months.

**Product competitiveness** = We organize a salon-style session to discuss the plan thoroughly every week.

**Product appeal** = We have a product appeal brought by the synergy effect of combining analog circuit technology, digital circuit technology, and application technology.

**Well-established environment** = We are capable of performing a timely type test at our test site certified and registered by the official body. We have achieved short-term prototype manufacturing using our dedicated prototype production line.

## Let us handle your open network needs for controllers.

Open concept of the communication technologies for FA control, PA control, and BA control is a trend quickly spreading in the industry. We have been developing products using various open control network to meet our customers' needs by streamlining the production system, improving the device functionalities, and reducing the wiring between the devices.

### List of networks supported

EtherCAT

EtherNet/IP

Modbus/TCP

MECHATROLINK

HLS Hi-speed Link System

FLEX NETWORK

CC-Link

CC-Link IE field

CC-Link IETSN

PROFIBUS

DeviceNet

Modbus

LONWORKS

T-Link

FL-net

HART COMMUNICATION PROTOCOL

OPC UA

BACnet MS/TP



# Turning an idea into a product

We have a dedicated marketing department to catch up with the fast-changing market. We have emphasis on the R&D (Research and Development) activities such as reflecting new information on our new products at the weekly marketing salon. In our development process, we quickly create a prototype in the dedicated prototype production line. The test site certified and registered by the official body also allows us to develop new products on a timely basis.

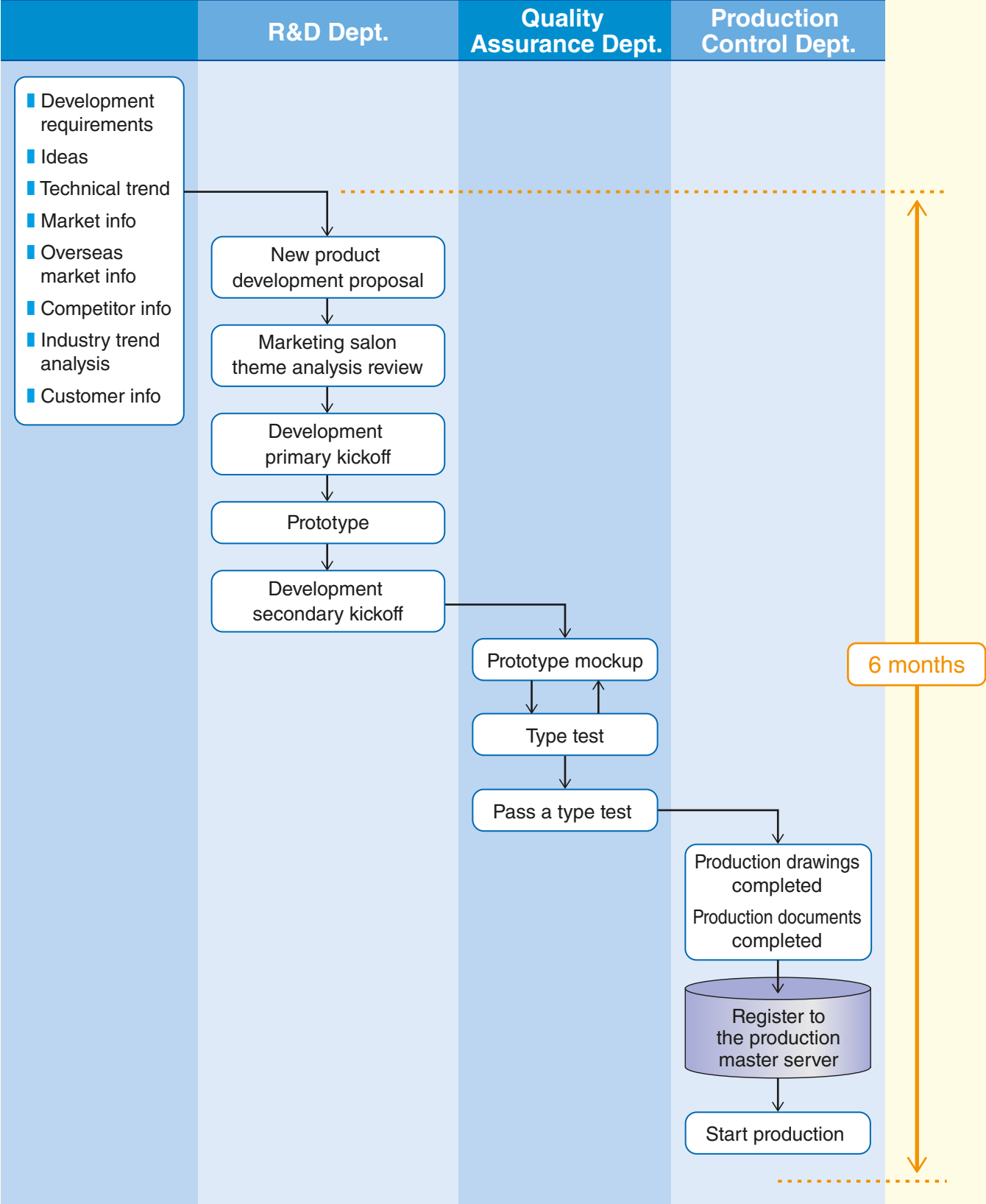

**Contact our Customer Center for any question**

- We take your call immediately.
- Your call will be attended quickly.

Our Customer Center receives hundreds of phone calls daily. We receive various inquiries by phone, such as questions about delivery date and pricing, expediting the delivery, technical questions about the product, troubleshooting, request for a meeting on the specifications, and product support request, etc. If we need to make adjustments with the related department internally regarding the question or inquiry, we will make sure to have the person who received your inquiry get back to you as soon as possible.

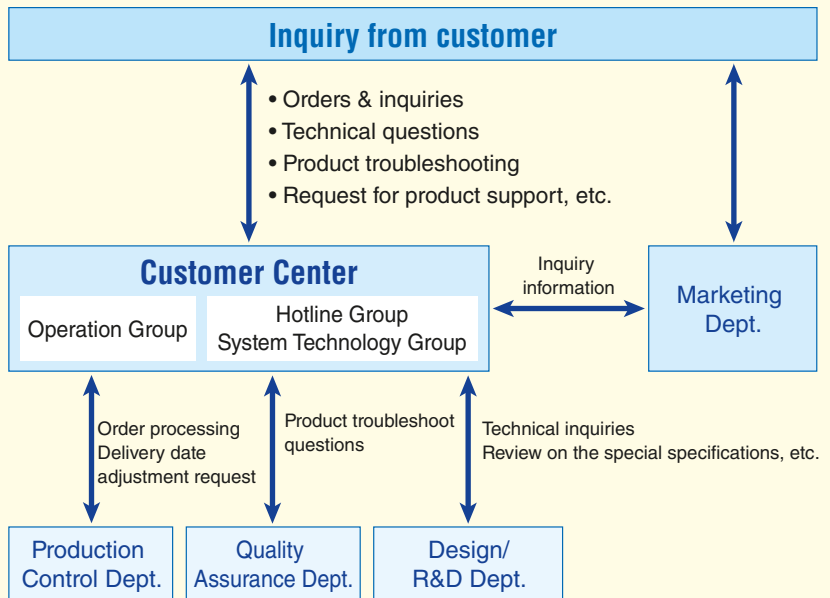

**We will answer your question immediately when you contact the hotline.**

Even the request we cannot meet by our standard products, we will come up with the best solution for the customers by combining several types of signal conditioners or accommodating the special specifications.

**Even if it seems a difficult problem, just call our hotline.**

There may be a possibility we may not be able to meet the product request. For such inquiries we were unable to meet, we will accept them as customers' request and save them in the database to determine if we need to improve our products further or to develop new products in our daily operation. We may develop a new product from such request. Even if it seems like an unreasonable request, just call our hotline.

**[Examples of products we developed from customers' requests]**

- Absolute Value Output Transmitter (model: W2VABS)
- Digital Panel Meter (totalized pulse input) (model: 47LPQ)
- Encoder Signal Distributor (model: WRPP)

Contact us if you have any troubles

# Customer Center

Just pick up the phone and call our Customer Center. Our Customer Center consists of "operation group" that handles inquiries regarding orders, "hotline group" that handles technical inquiries, and "system technology group" that handles support inquiries on the system architecture.

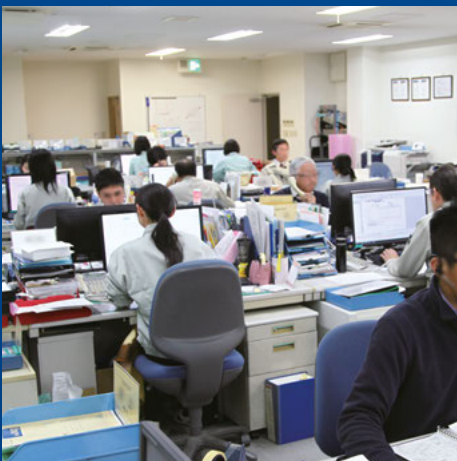

# How we process your order

## We supply our products in fast and precise delivery time.

The standard manufacturing lead time for most products with customer’s specified range is 5 days. But more than quarter of the total shipments are delivered in shorter lead time, and Quick Service Center (QSC) expedites hundreds of orders every month on the same day or the next day after ordered. So do not worry too much about the standard delivery. Just let us know ‘When’ you need one of our products. Once a delivery time is promised, you can of course count on us to deliver them precisely on time.

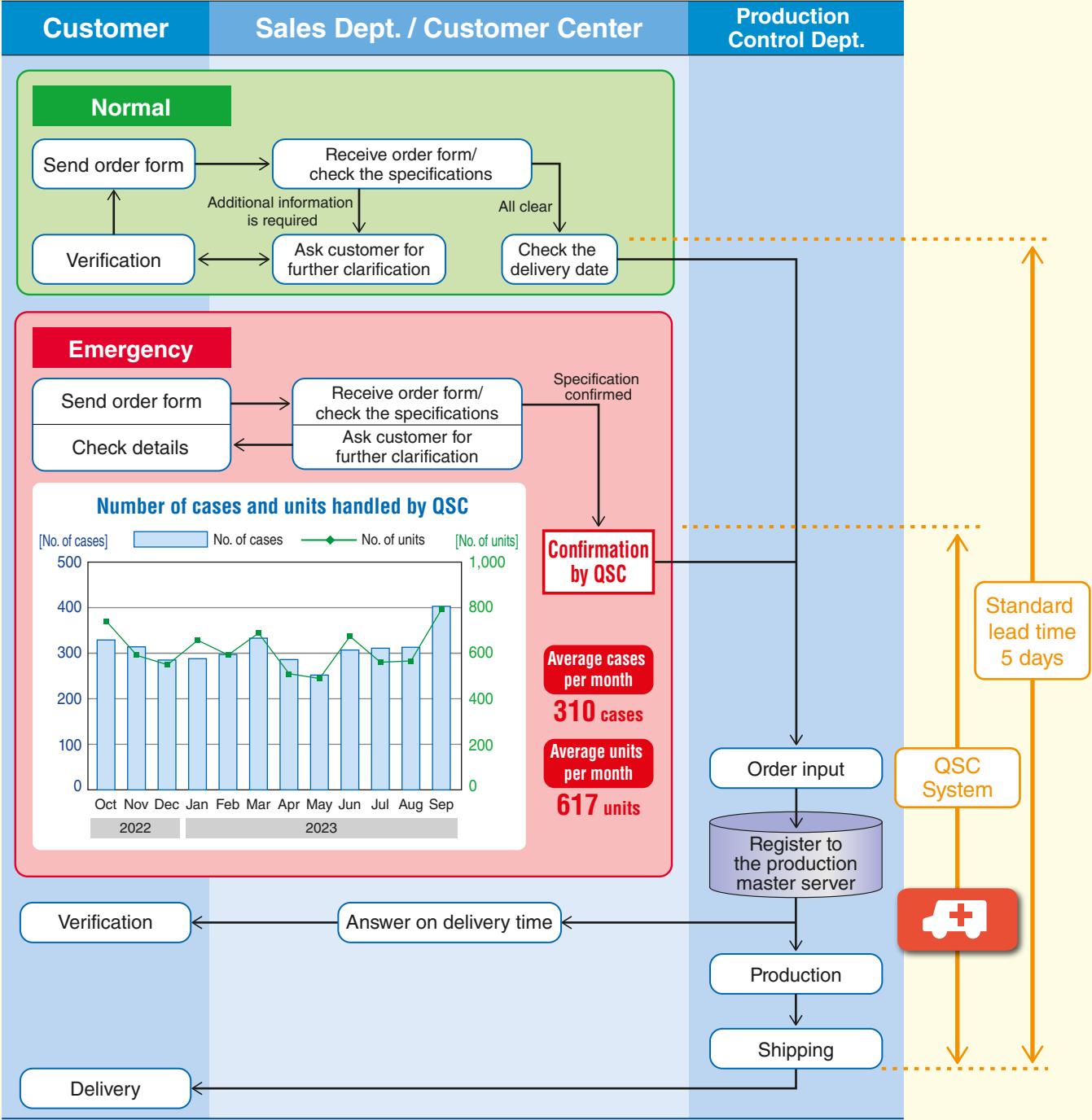

### About quick delivery

Contact us if you have troubles with delivery time. We will check the specifications you request and propose a model that we can provide you in the shortest delivery time. For an emergency, we might use the “Same day or next day production” even for the models not supported by the Quick Service Center.



## Statistics on the parts outage

Number of electrical parts outage

**237 cases** (2023)

Number of times of designing changes by parts outage

**16,910 times** (2023)

Once released in the market

# Production system

which we do not easily stop manufacturing products without compatible replacements

The greatest difficulty to keep production of the electronic devices is either by due to the interruption of electronic parts supply caused by accident or disaster, change in regulation or parts discontinued.

We do not easily stop manufacturing products once released in the market, without trying to supply compatible products of equal or better performance to replace with, because we believe it is an important responsibility as the world's leading manufacturer to continue serving people who maintain the performance of process control systems.

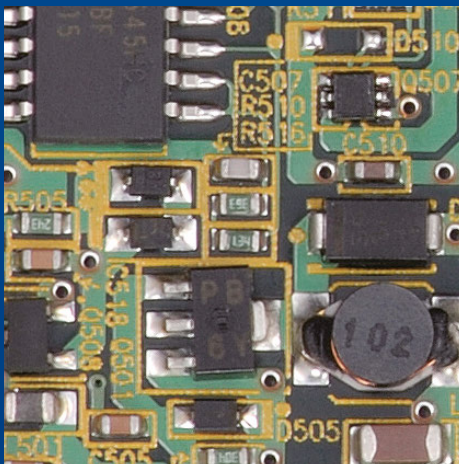

## Electrical parts outage and historical background

When obtaining the electrical parts becomes difficult, we tend to think that it is due to the one-sided situation of the parts manufacturers, but it is not always the case. The designing change was necessary in some cases to comply with the RoHS directive, a part of the global environment activities. Also, there were cases where obtaining the parts was difficult when the parts factory was damaged by the Great East Japan Earthquake or when the factory in Thailand was flooded.

### Number of times of designing changes by the parts outage

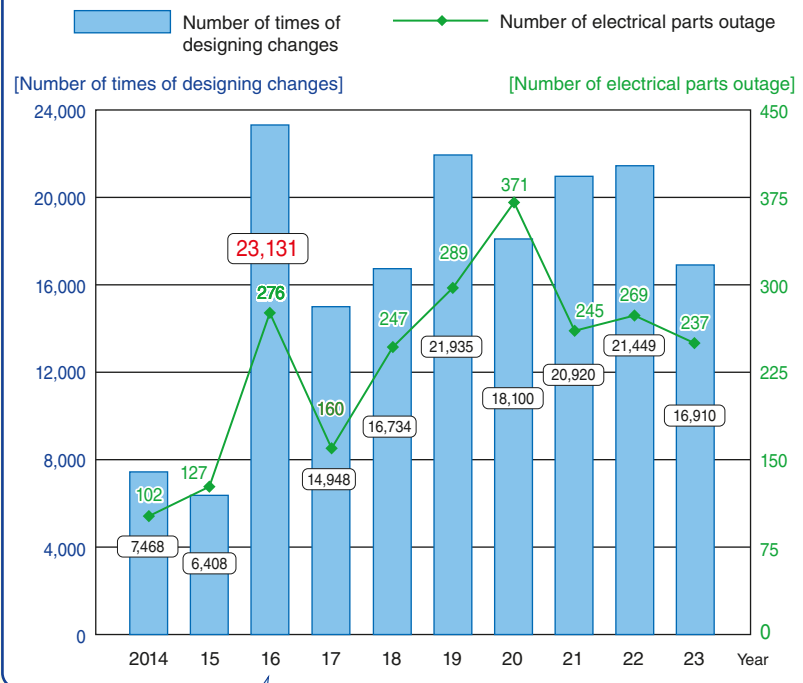

- We started using a new transformer component manufacturer due to the previous manufacturer's abolition of transformer component business.  
Designing changes: 5,588 times
- We started using a new semiconductor manufacturer due to the previous manufacturer's abolition of semiconductor components as a result of its business office integration.  
Designing changes: 4,707 times

# Electrical parts outage and design changes

## If we cannot avoid supply outage of electronic parts, we will cover it by the designing speed.

If the electronic parts will be discontinued, we will receive an advance notice from the parts manufacturer. As soon as the notice is received, the Design Dept. will calculate the time required for designing change. The Production Control Dept. will calculate the volume of shipping within the designing period and order the necessary quantity to the parts manufacturer.

If it involves circuit changes, we will need to redo many processes including evaluation test. However, we have our own test facilities such as the anechoic chamber and the shielded room certified and registered by the official body to perform the change tasks efficiently at any time.

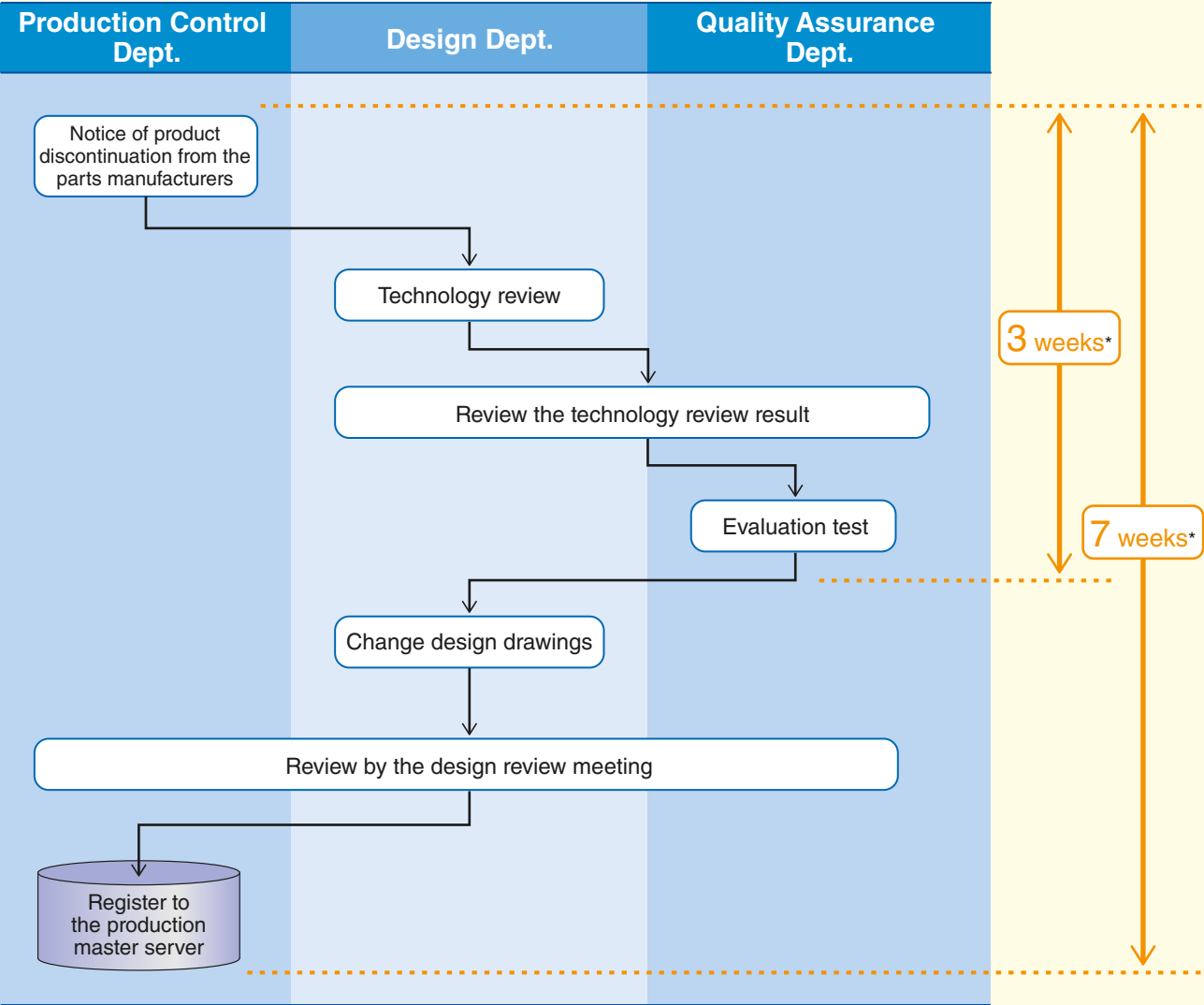

\* Please allow us further two months to modify the entire printed board.



## Statistics on special specification items

Number of reviewing annual average special specification

Approx. **650** cases

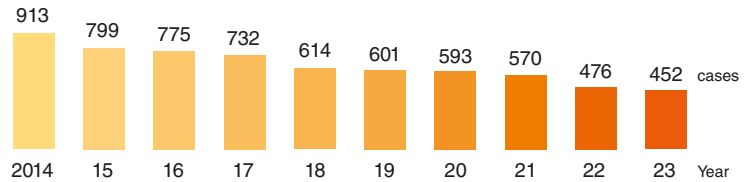

The trend for the number of reviewing special specification

## Flow from inquiring special specification items to the shipping

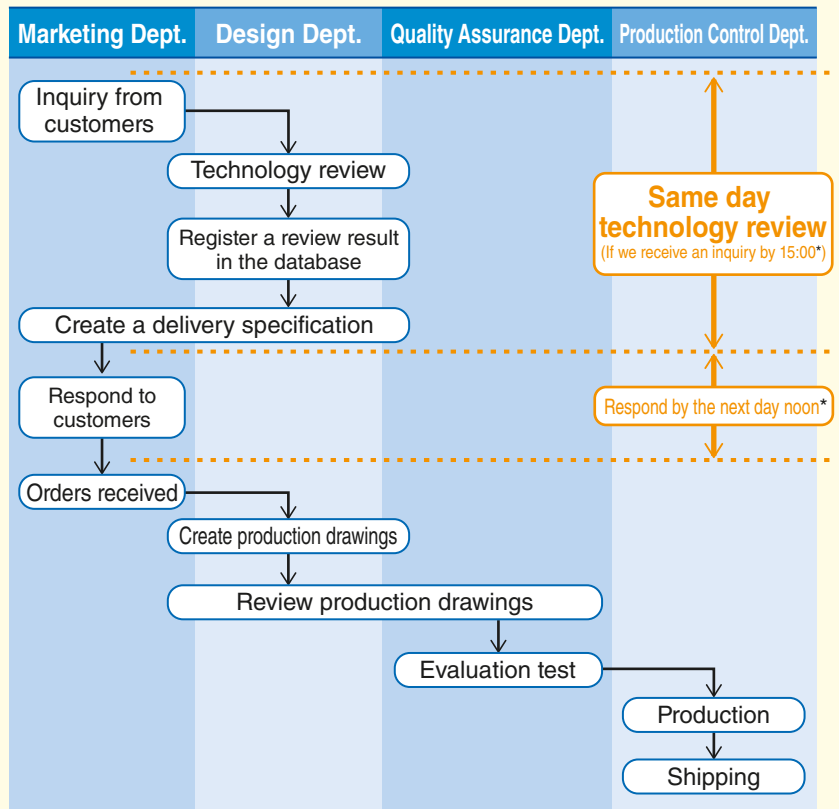

\*Japan Standard Time

## We strive toward complete offerings with special specification products.

We offer an enormous selection of signal conditioners and remote I/Os, power monitors, paperless recorders, panel meters, surge suppressors and valve actuators, and even that may not be enough for your particular needs. But do not give up easily. Just ask us. We continue to work toward full product offerings with special specifications without additional charge, starting with major product series. In addition, we put our effort to make them into standard selections so that they are more easily accessible to you and everyone else in the future.

Contact us  
if you have any troubles

# Special specifications without additional charge

“Oh No! We need to convert a sensor signal that is not found in the standard.” Have you encountered a situation like this?

It takes some efforts to look for products called special specification items. In the case like this, just contact us. We will do anything we can even for special specifications by utilizing our long-year experiences and analog technology accumulated.

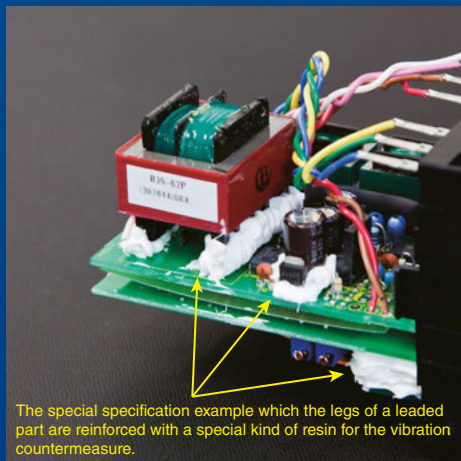

The special specification example which the legs of a leaded part are reinforced with a special kind of resin for the vibration countermeasure.



# Flow of transforming a special specification item into a standardized item

We will standardize the special specification items, beginning with the ones most requested. Once they are standardized, you will no longer need troublesome meetings or specification check when you place an order.

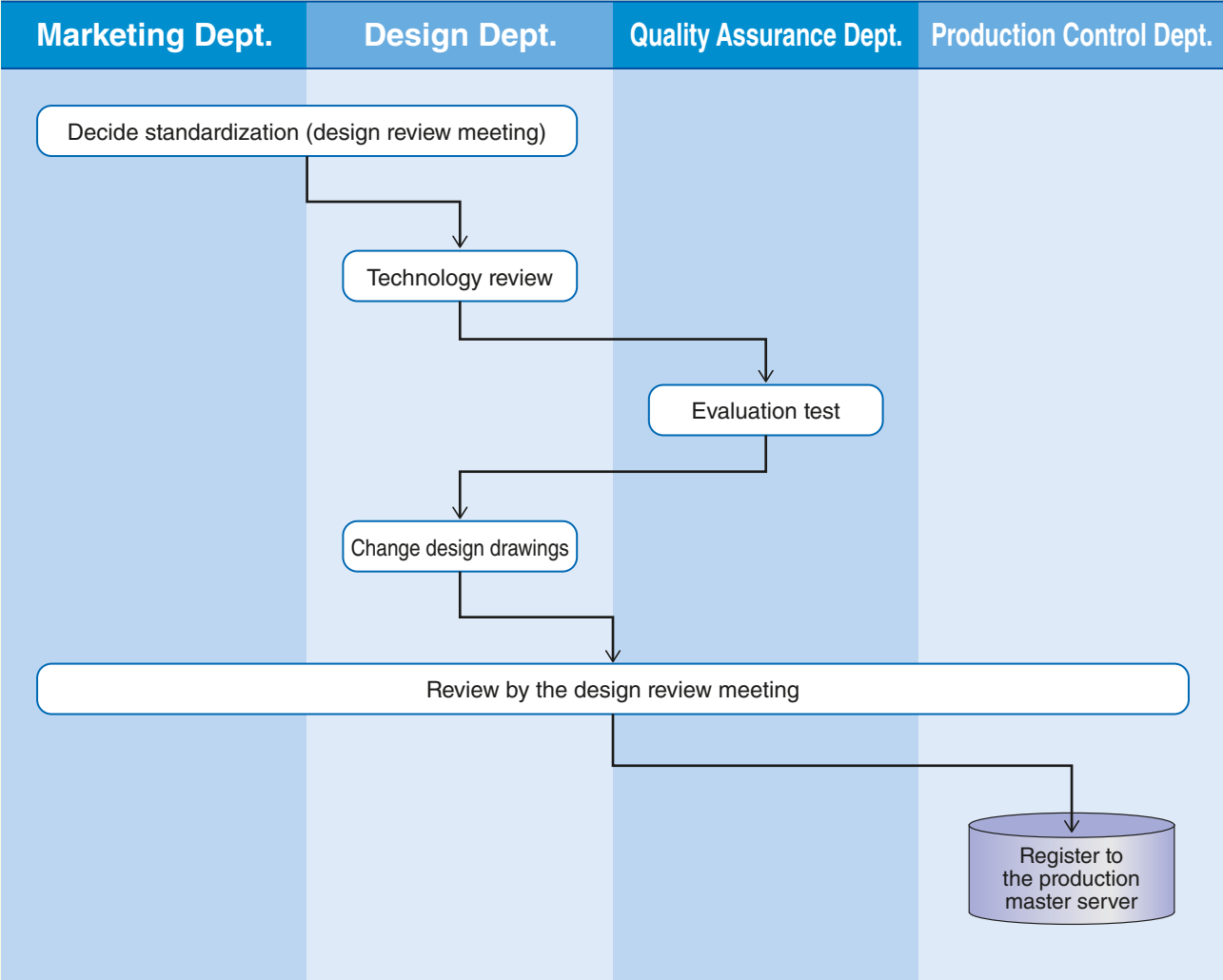

Number of standardizing special specifications

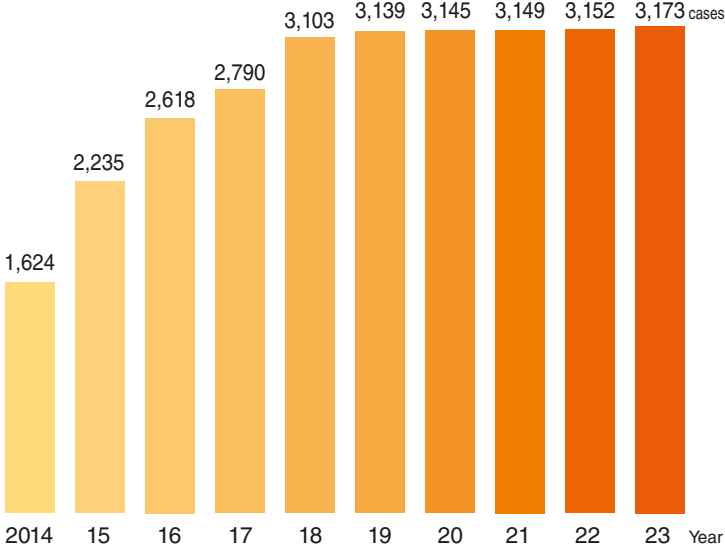

Various special specifications (request examples from customers)

- **The range does not match with that of the standard specification**  
We want to set the ranges of input signal and output signal to the ones not included in the existing code.
- **We want to combine with the special sensor**  
We want to combine with special sensor or thermistor not included in the standard.
- **Different power supply voltage**  
We want to use the power supply compatible with the special CVCF (constant voltage and constant frequency unit).  
We want to match a marine power supply.
- **We want to have our desired response speed**  
Excessively fast response speed picks up the noise, so we want the optimal value.
- **We want an external volume**  
We want to attach the volume to adjust the bias of the ratio conditioner onto the control panel surface.

## Statistics on our Quality Assurance Dept.

### Evaluation test

Our Quality Assurance Dept. conducts a prototype evaluation before releasing a new product. We validate the products based on the various regulations / standards and the company standards mainly classified into four categories. In addition, we conduct an EMC\*1 test as a part of the evaluation test. Our anechoic chamber used for the EMC test is certified and registered by the official body (VCCI\*2), and we conduct an official test instead of a simplified test.

Company standards	Number of standards
Standards on the functions	42
Standards on the performance	33
Standards on the reliability	48
Standards on the mechanism	9
<b>Total</b>	<b>132</b>

# Strong emphasis on quality assurance system



Anechoic chamber certified and registered by the official body (VCCI\*2)

A large shielded room of 6 m x 6 m where multiple tests can be conducted simultaneously



The EMC test required to acquire the CE marking has the following test items and all of them are conducted by our own facility at Kyoto Techno Center (Kizugawa-City, Kyoto).

### Type tests required by EMC Directive

Referenced standard	Base standard	Test	Test site
EN 61000-6-2	EN 61000-4-2	Electromagnetic discharge immunity test	Shielded room
	EN 61000-4-3	Radiated, radio-frequency, electromagnetic field immunity test	Anechoic chamber
	EN 61000-4-4	Electrical fast transient / burst immunity test	Shielded room
	EN 61000-4-5	Surge immunity test	Shielded room
	EN 61000-4-6	Immunity against conducted emission induced by radio-frequency fields	Shielded room
	EN 61000-4-8	Power frequency magnetic field immunity test	Shielded room
	EN 61000-4-11	Voltage dips, short interruptions and voltage variations immunity tests	Shielded room
EN 61000-6-4	CISPR16-1-1 CISPR16-1-4 CISPR16-2-3	Radiated Emission	Shielded room
	CISPR16-1-1 CISPR16-1-2 CISPR16-2-1	Conducted Emission (Power Port)	Shielded room
	CISPR32	Conducted Emission (Communication Port)	Shielded room



As a part of our efforts for quality enhancement, we received an ISTQB\*3 partnership level "Gold Partner", which is a global scheme to certify companies and organizations devoted to improve quality management and testing skills.

- \*1. EMC (Electro Magnetic Compatibility): Tests to check the effect by applying an electromagnetic noise to a device and to measure the electromagnetic wave and conductive common mode noise emitted from the device.
- \*2. VCCI (Voluntary Control Council for Interference by information technology equipment): Formerly known as Voluntary Control Council for Information Technology Equipment. An industry organization in Japan that discusses the regulations on the radio waves emitted from the information technology equipment
- \*3. ISTQB (International Software Testing Qualifications Board): Established in November 2002, ISTQB is a non-profit organization that provides internationally-recognized certification scheme to validate testing skills of software test engineers.

Kyoto Techno Center has the Reliability Testing Section of the Quality Assurance Dept. to conduct a type test of all products to be released. We conduct a type test to verify the quality on not only new products but also products of which we changed the design.



# Vibration test system combined with temperature and humidity

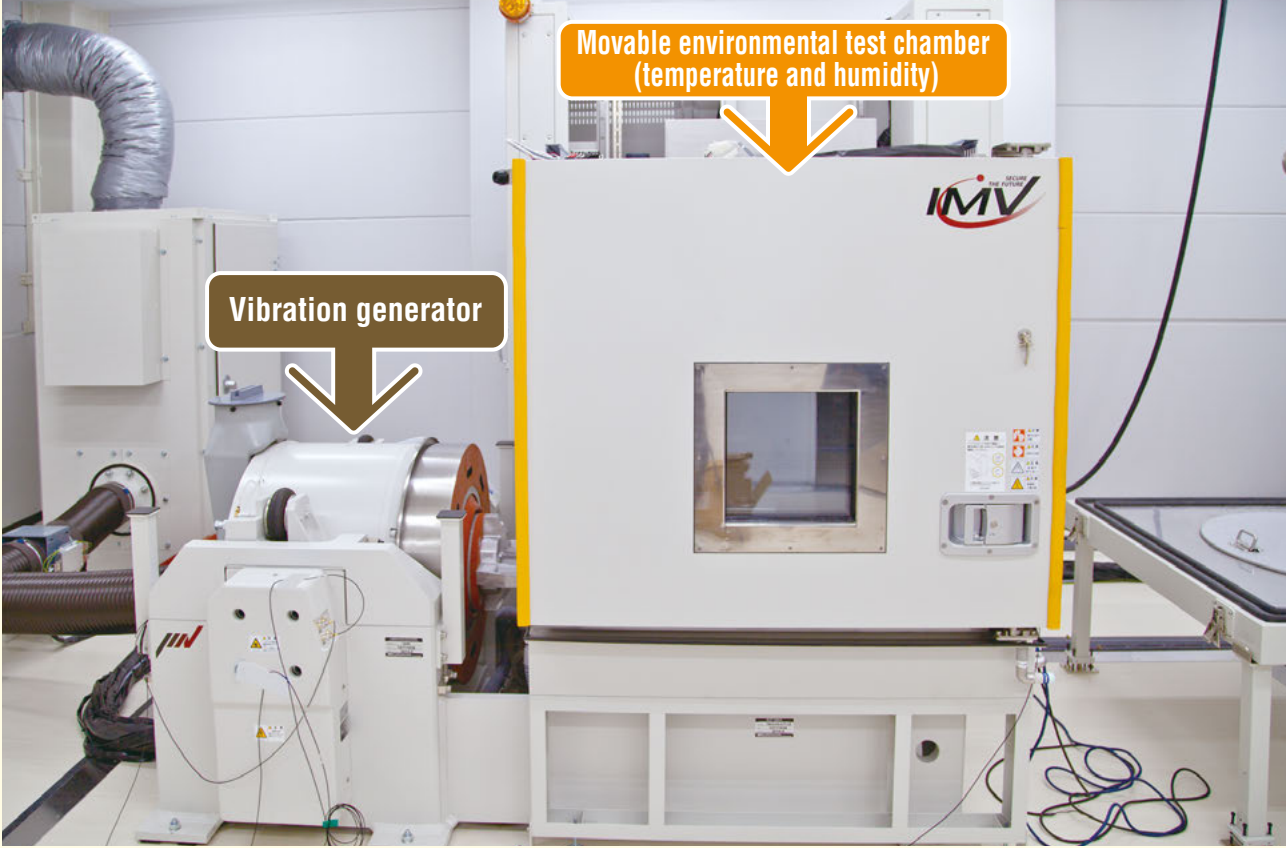

We completed the vibration testing facility at Kyoto Techno Center in June 2014. It is combined with the environmental test chamber by which the vibration test can be conducted both vertically and horizontally under the harsh environments to cover the temperature -40°C to +140°C and the humidity 20% to 90% RH.

### Improvements in environmental durability

The reliability and durability of electronic devices and highly mechanized mechatronic products is significantly affected by environmental stresses such as temperature, humidity, and vibration. It was thus determined that there was a need for vibration tests which served as environmental tests for products, and combined vibration tests including temperature and humidity. We carry out tests in order, beginning with products which are called on to endure particularly severe environments.

### Improvements in development speed

Formerly we outsourced comparatively heavy products such as mechatronics and single-loop controllers to external test sites, but these sites were often fully booked, making rapid response difficult. We are now able to respond rapidly, as we can run the site as a dedicated facility for our products.

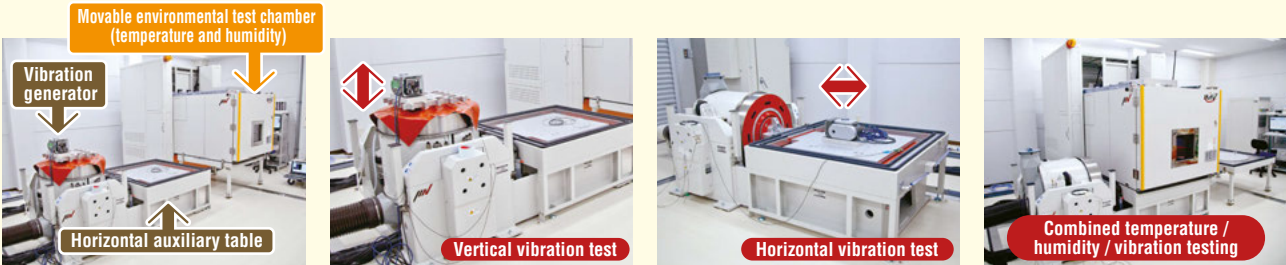

## Special Repair Service

Based on our “Customer Creed” policy, we go beyond normal manufacturers’ obligations with our special repair service. If you suspect damage to a product by mistakes in handling, contact our Customer Center. We would be happy to check and repair it without charge. Consult our web site for detailed terms and conditions applicable to this service.



Core production facility with the test plant of the air-conditioning control system

# Kyoto Research Center & Factory

Kyoto Research Center & Factory is not only an important manufacturing site for us but is also a showcase plant using our BA controllers.

We invite building owners, component suppliers and building contractors to show our controllers and I/Os in operation.

We will be happy to receive you at our Kyoto factory any time.



## Risk Management

Based on lessons we learned from the Great East Japan Earthquake, we made an overall review of our existing BCP (Business Continuity Plan) and disaster prevention schemes. In order to minimize the impact on product supply during a large-scale disaster and to fulfill our social responsibility of business, we worked on enhancing BCP by implementing anti-inundation and anti-earthquake measures as well as strengthening the logistics to allow our core manufacturing sector to continue operations and quickly recover from such disaster.

## Multiple production sites

Our Kyoto Research Center & Factory is located in suburban area where the elevation is 62 meters above sea level.

\* Characteristics of medium-pressure gas pipe

The medium-pressure gas pipes will not stop the gas supply as they are strong enough to withstand massive earthquakes like the Great Hanshin/Awaji Earthquake and the Great East Japan Earthquake.

We have constructed a highly-reliable energy supply system by supplying gas to the cogeneration systems through the medium-pressure gas pipes.

## Shelter Area for Power Outage

We have set up an area to “maintain power supply to the power outlets and keep the air-conditioning and lighting on” in order to keep our employees safe and to maintain the production system in case of a power outage.

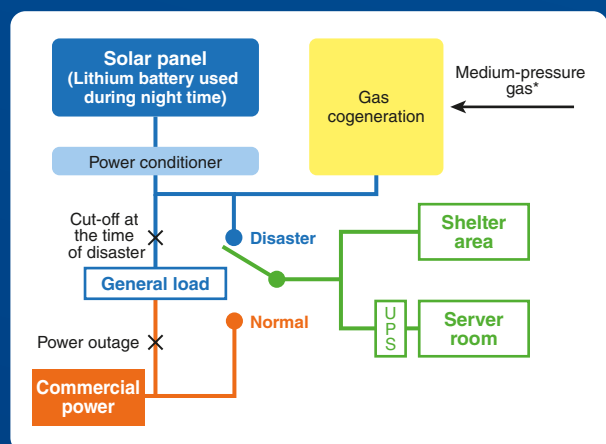

# Facilities in Kyoto Research Center & Factory

- Central air-conditioning control system
- Energy-saving monitoring system
- Diversification of energy sources and energy-saving measures

● **Gas cogeneration system**  
 Generate power by gas engines (35 kwh x 2 units) and at the same time utilize waste heat for central air conditioning.

● **Solar power generation**  
 High-efficiency solar cell (approx. 15 kwh) installed.

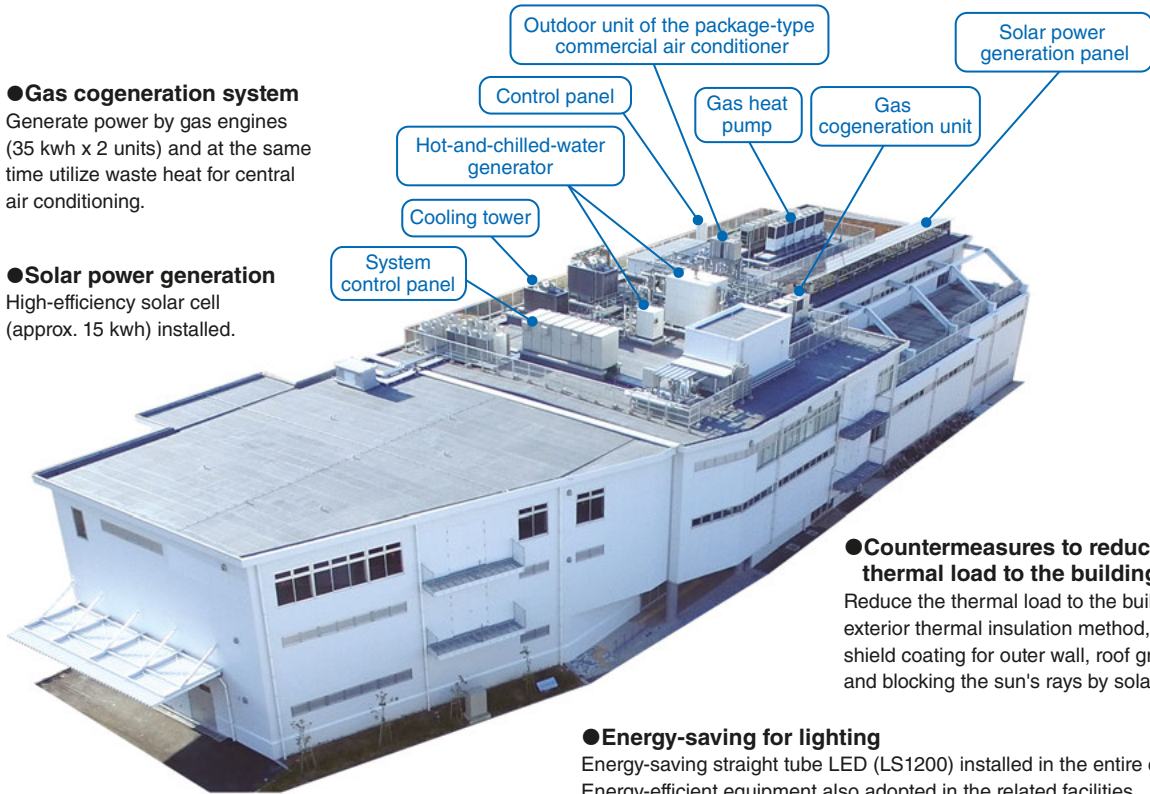

● **Countermeasures to reduce thermal load to the building**  
 Reduce the thermal load to the building by exterior thermal insulation method, heat shield coating for outer wall, roof greening, and blocking the sun's rays by solar panels.

● **Energy-saving for lighting**  
 Energy-saving straight tube LED (LS1200) installed in the entire center. Energy-efficient equipment also adopted in the related facilities.



OHU seen from outside



Solar power generation panel



Hot-and-chilled-water generator



Emergency-ready Gas cogeneration



Lithium-ion battery



Multiple in-line chip mounters (1st floor)



Storage for parts (2nd floor)



Power outage shelter area (3rd floor)  
 (Red power outlet can be used even during power outage)

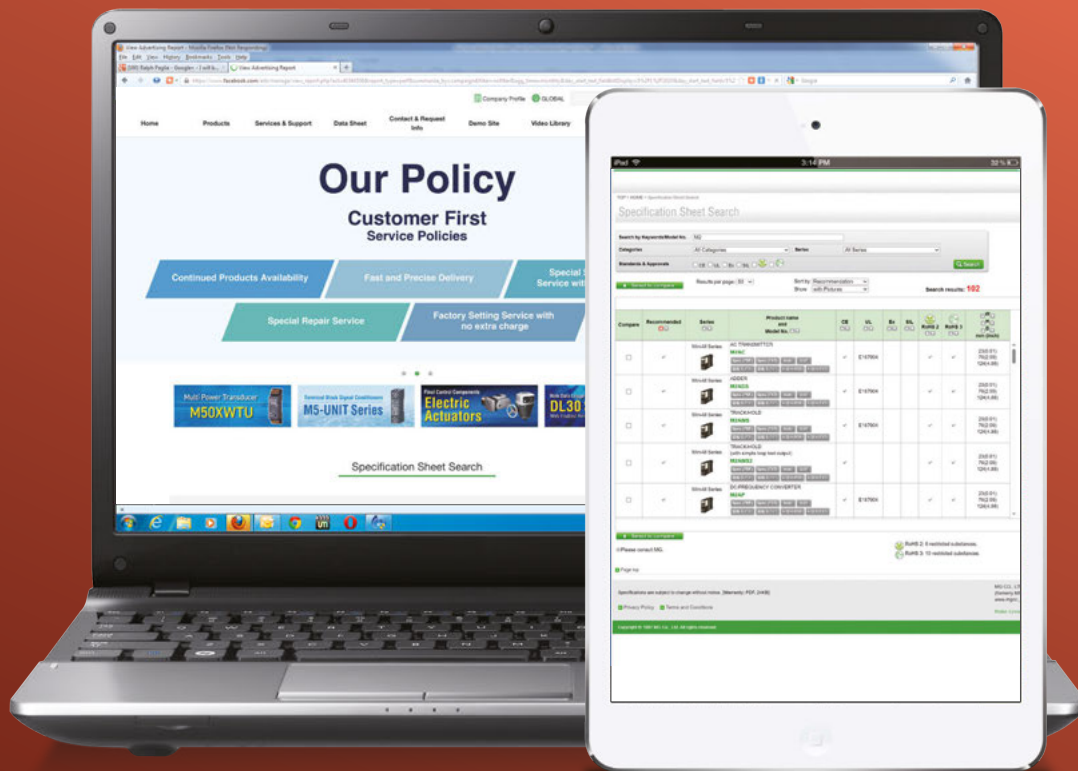

## Statistics on our...

### Website

Total number of visitors

Approx. **6,700**  
people/day

Total number of pages

Approx. **5,100**  
pages

Japanese, English, Chinese, and Korean websites.

### Website (documents)

The number of documents available for search

Approx. **18,700**  
documents or more

Total number of pages

Approx. **112,200**  
pages or more

Japanese, English, Chinese, and Korean documents.



Website



Request Info

Your local representative:

MG CO., LTD.  
(formerly M-System Co., Ltd.)  
www.mgco.jp