

PULSE SCALER	MODEL 10PR
---------------------	-------------------

BEFORE USE

Thank you for choosing us. Before use, please check contents of the package you received as outlined below. If you have any problems or questions with the product, please contact our sales office or representatives.

PACKAGE INCLUDES:

- Signal conditioner(1)
- Mounting screw (M3.5 × 10).....(2)

MODEL NO.

Confirm Model No. marking on the product to be exactly what you ordered.

INSTRUCTION MANUAL

This manual describes necessary points of caution when you use this product, including installation, connection and basic maintenance procedures.

POINTS OF CAUTION

POWER INPUT RATING & OPERATIONAL RANGE

- Locate the power input rating marked on the product and confirm its operational range as indicated below:
24V DC rating: 24V ± 10%, approx. 80mA

GENERAL PRECAUTIONS

- Before you remove the unit or mount it, turn off the power supply and input signal for safety.

ENVIRONMENT

- Indoor use.
- When heavy dust or metal particles are present in the air, install the unit inside proper housing with sufficient ventilation.
- Do not install the unit where it is subjected to continuous vibration. Do not subject the unit to physical impact.
- Environmental temperature must be within -5 to +55°C (23 to 131°F) with relative humidity within 30 to 90% RH in order to ensure adequate life span and operation.

WIRING

- Do not install cables close to noise sources (relay drive cable, high frequency line, etc.).
- Do not bind these cables together with those in which noises are present. Do not install them in the same duct.
- Be sure to put the terminal cover on while the power is supplied.

FILTER

- The 10PR is designed to accept at the maximum of 100 kHz, which may cause errors due to chattering in the input pulses.
Use input relays which do not cause chattering. Other relays could be used only with a CR filter, for 10 Hz at maximum.

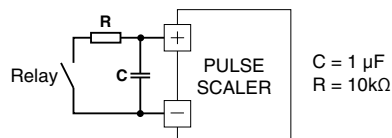

AND

- The unit is designed to function as soon as power is supplied, however, a warm up for 10 minutes is required for satisfying complete performance described in the data sheet.
- The 10PR's output waveform is not uniform due to its scaling method. The user must be aware that it may be inconvenient for certain types of application.

COMPONENT IDENTIFICATION

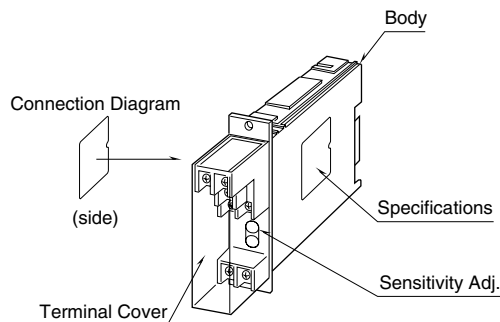

INSTALLATION

Use Standard Rack (model: 10BXx).

TERMINAL CONNECTIONS

Connect the unit as in the diagram below or refer to the connection diagram on the side of the unit.

EXTERNAL DIMENSIONS unit: mm (inch)

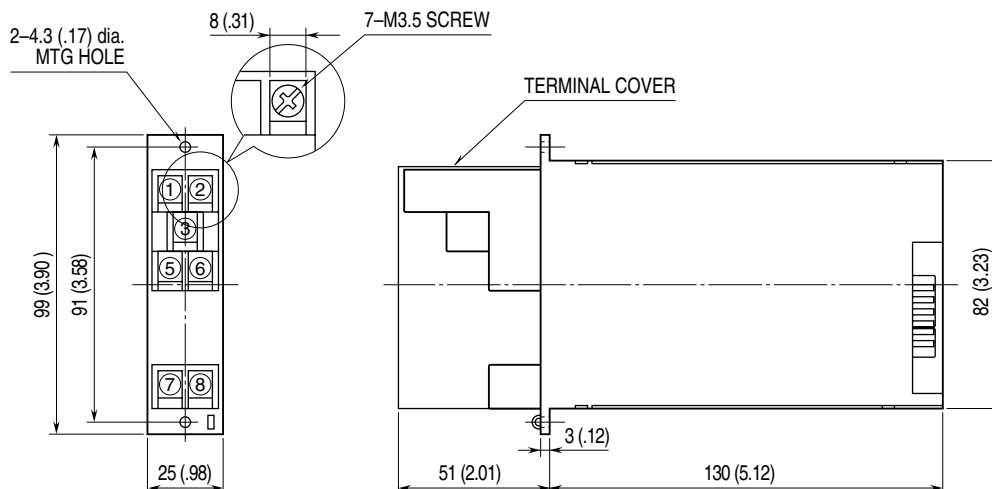

CONNECTION DIAGRAM

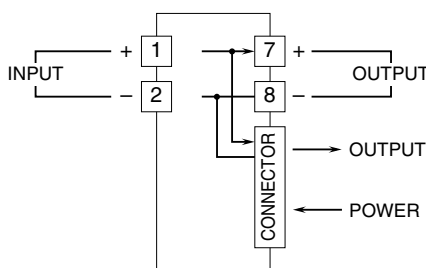

Input Connection Examples

■ Dry Contact

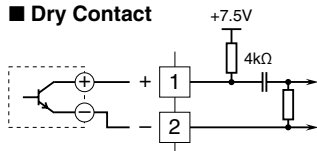

■ Voltage Pulse

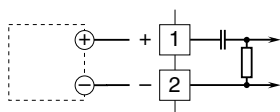

Output Connection Examples

■ Open Collector

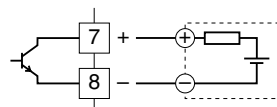

■ Voltage Pulse

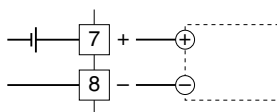

■ Relay Contact

• AC Powered

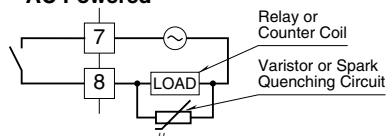

• DC Powered

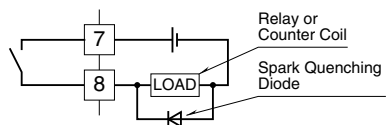

WIRING INSTRUCTIONS

■ SCREW TERMINAL

Torque: 0.8 N·m

CHECKING

- 1) Terminal wiring: Check that all cables are correctly connected according to the connection diagram.
- 2) Power input voltage: Check voltage supplied to the rack (model: 10BXx). For the DC power source, be sure that the ripple level is within 10% p-p.
- 3) Input: Check across the terminal 1 – 2 on an oscilloscope. With voltage pulse input, check that the pulse amplitude meets the required level according to the following table.

• Input Frequency & Required Amplitude (duty ratio 50 ±10%)

INPUT FREQUENCY	AMPLITUDE REQUIREMENT
0 – 2 kHz	≥ 25mV p-p
0 – 20 kHz	≥ 50mV p-p
0 – 40 kHz	≥ 1V p-p
0 – 100 kHz	≥ 5V p-p

• Input Pulse Width & Required Amplitude (duty ratio other than 50 ±10%)

INPUT PULSE WIDTH	AMPLITUDE REQUIREMENT
5 μsec.	≥ 5V p-p
10 μsec.	≥ 3.5V p-p
50 μsec.	≥ 2V p-p
100 μsec.	≥ 1V p-p
500 μsec.	≥ 0.5V p-p

- 4) Output: Check that the load resistance meets the described specifications as shown below.

OUTPUT	LOAD REQUIREMENT
Open collector	50V DC @ 50mA max.
5V voltage pulse	≥ 600 Ω
Relay contact	24V DC @ 200mA max. (resistive load) 120V AC @ 200mA max. (cosφ=1)
24V voltage pulse	≥ 800 Ω

ADJUSTMENT PROCEDURE

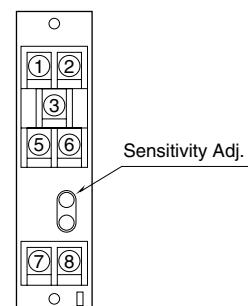

■ Sensitivity Adjustment

Avoids noise by lowering the sensitivity to the lowest required value. Adjust by gradually increasing the sensitivity until the maximum input frequency appears on the output. Not necessary with dry contact switches.

LIGHTNING SURGE PROTECTION

We offer a series of lightning surge protector for protection against induced lightning surges. Please contact us to choose appropriate models.