

BEFORE USE

Thank you for choosing us. Before use, please check contents of the package you received as outlined below. If you have any problems or questions with the product, please contact our sales office or representatives.

■ PACKAGE INCLUDES:

- Bargraph indicating alarm.....(1)
- Mounting bracket.....(2)
- Engineering unit label sheet.....(1)

■ MODEL NO.

Confirm Model No. marking on the product to be exactly what you ordered.

■ INSTRUCTION MANUAL

This manual describes necessary points of caution when you use this product, including installation, connection and basic maintenance procedures.

POINTS OF CAUTION

■ POWER INPUT RATING & OPERATIONAL RANGE

- Locate the power input rating marked on the product and confirm its operational range as indicated below:
 85 – 264V AC rating: 85 – 264V, 50/60 Hz, approx. 7VA
 24V DC rating: 24V ±15%, approx. 6W

■ GENERAL PRECAUTIONS

- Before you remove or mount the unit, turn off the power supply and input signal for safety.
- When installing the unit into a panel, first remove the mounting brackets at the top and bottom of the front panel, sliding them forward as shown in the figure below.

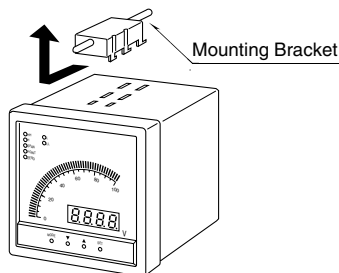

- Insert the unit from the front into the panel and attach the mounting brackets back on the unit. Turn the screws clockwise using a minus screwdriver until the unit is secured. Turn the screws counterclockwise to loosen the brackets and separate them from the unit.

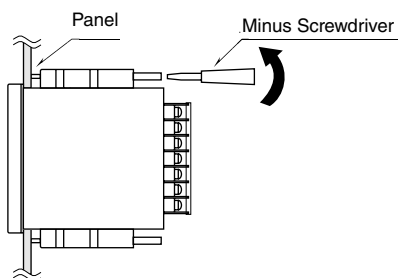

■ ENVIRONMENT

- Indoor use.
- When heavy dust or metal particles are present in the air, install the unit inside proper housing with sufficient ventilation.
- Do not install the unit where it is subjected to continuous vibration. Do not subject the unit to physical impact.
- Environmental temperature must be within 0 to 45°C (32 to 113°F) with relative humidity within 40 to 80% RH in order to ensure adequate life span and operation.

■ WIRING

- Do not install cables close to noise sources (relay drive cable, high frequency line, etc.).
- Do not bind these cables together with those in which noises are present. Do not install them in the same duct.

■ AND

- The unit is designed to function as soon as power is supplied, however, a warm up for 10 minutes is required for satisfying complete performance described in the data sheet.

COMPONENT IDENTIFICATION

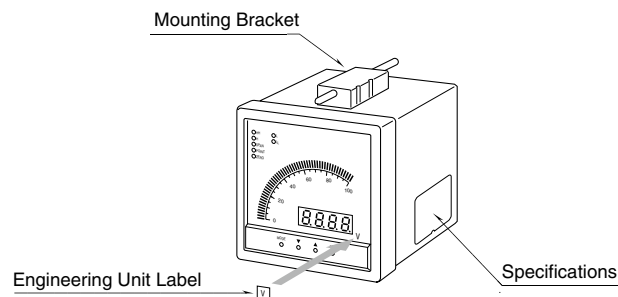

INSTALLATION

■ PANEL CUTOUT unit: mm (inch)

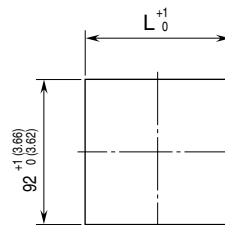

Panel thickness 1.6 – 5.5 mm
 $L = 96 \times (N - 1) + 92$ (mm)
 where N : number of units

TERMINAL CONNECTIONS

Connect the unit as in the diagram below or refer to the connection diagram on the rear of the unit.

EXTERNAL DIMENSIONS unit: mm (inch)

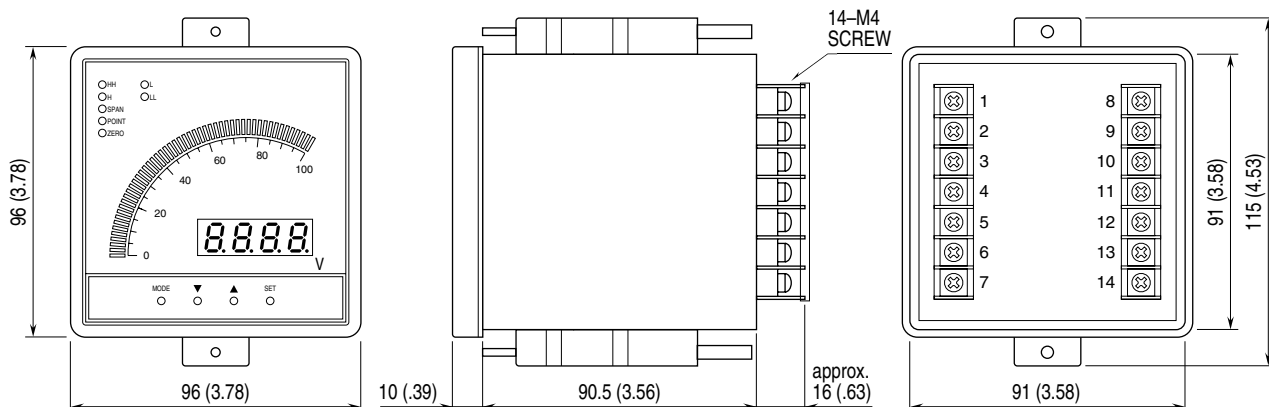

CONNECTION DIAGRAM

• 49AV2-0

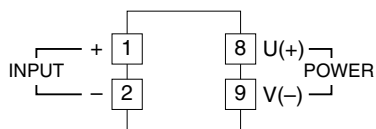

• Relay Protection AC Powered

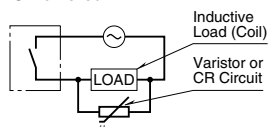

DC Powered

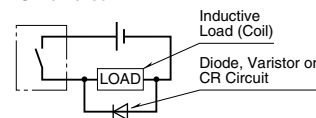

• 49AV2-2

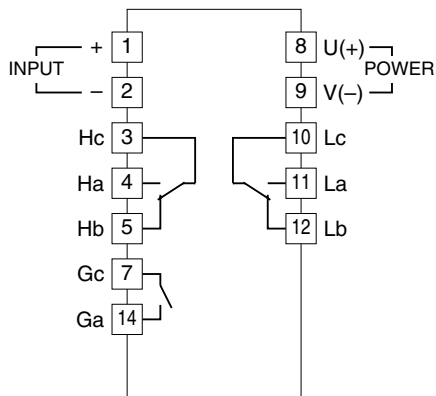

• 49AV2-4

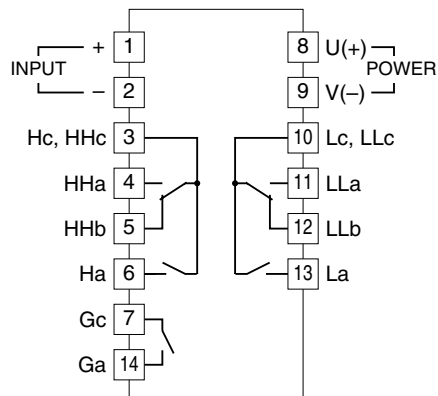

FRONT PANEL CONFIGURATION

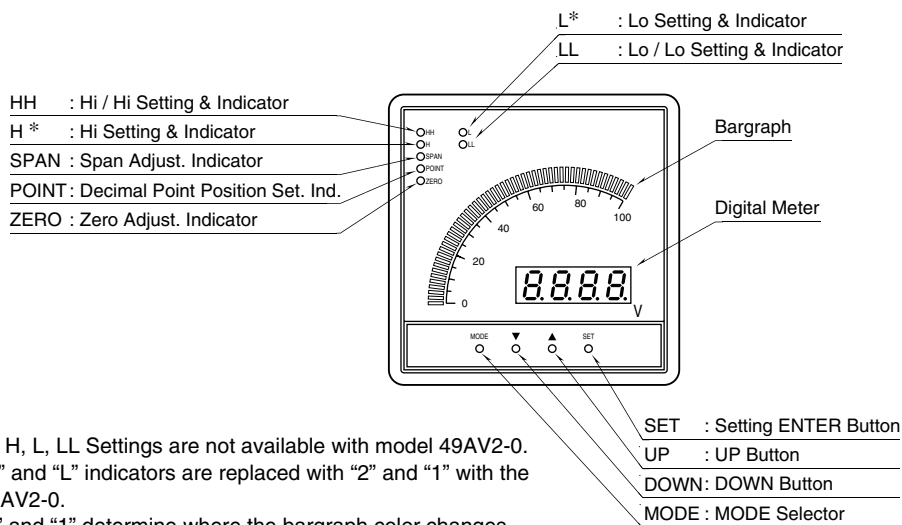

Note 1: HH, H, L, LL Settings are not available with model 49AV2-0.

* "H" and "L" indicators are replaced with "2" and "1" with the 49AV2-0.

"2" and "1" determine where the bargraph color changes.

Note 2: HH, LL Settings are not available with model 49AV2-2.

Multicolor Indication

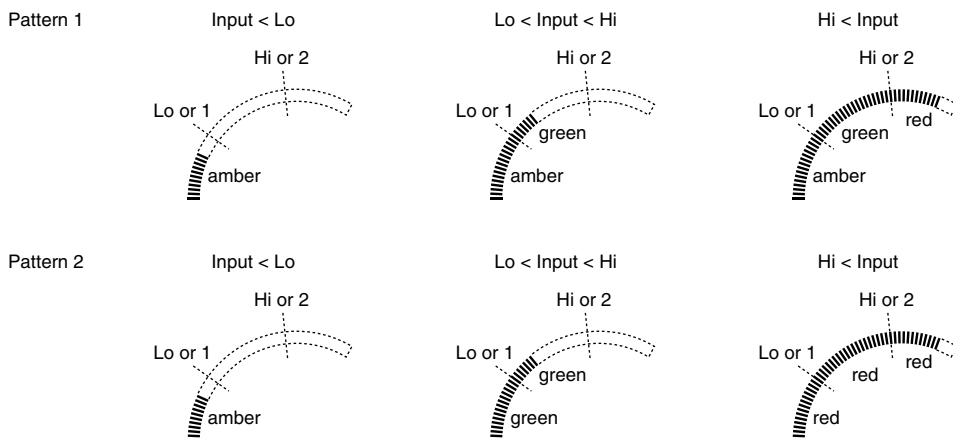

ADJUSTMENT PROCEDURE

■ TURNING OFF DISPLAYS

Pressing DOWN key for longer than 2 seconds when the unit is not in the adjustment mode will turn the digital display off. Pressing UP key for longer than 2 seconds likewise will turn the bargraph off. In order to return these displays on, proceed the same, or turn power supply off and on.

■ MULTI-COLOR PATTERN

Pressing UP and DOWN keys at once for longer than 2 seconds when the unit is not in the adjustment mode will switch between the Multi-Color Bargraph Pattern 1 and Pattern 2.

• Digital Zero Adjustment

- 1) Press MODE key once or several times until ZERO LED starts blinking.
- 2) Press UP or DOWN keys until the digital meter shows a desired 0% value.
- 3) Press SET key. The setting is complete and the ZERO LED turns off.

• Decimal Point Position Adjustment

- 1) Press MODE key once or several times until POINT LED starts blinking.
- 2) Press UP or DOWN keys to move the decimal point on the digital meter.
- 3) Press SET key. The setting is complete and the POINT LED turns off.

• Digital Span Adjustment

- 1) Press MODE key once or several times until SPAN LED starts blinking.
- 2) Press UP or DOWN keys until the digital meter shows a desired 100% value.
- 3) Press SET key. The setting is complete and the SPAN LED turns off.

• Low Setpoint Adjustment

- 1) Press MODE key once or several times until L* LED starts blinking.
- 2) Press UP or DOWN keys until the digital meter shows a desired L* setpoint.
- 3) Press SET key. The setting is complete and the L* LED turns off except in Low alarm state.

*Replaced with '1' LED or '1' setpoint for the display-only type. With no alarm, this adjustment determines the position where the LED color changes.

• LL Setpoint Adjustment (for 4-point alarm output type only)

- 1) Press MODE key once or several times until LL LED starts blinking.
- 2) Press UP or DOWN keys until the digital meter shows a desired LL setpoint.
- 3) Press SET key. The setting is complete and the LL LED turns off except in LL alarm state.

• High Setpoint Adjustment

- 1) Press MODE key once or several times until H* LED starts blinking.
- 2) Press UP or DOWN keys until the digital meter shows a desired H* setpoint.
- 3) Press SET key. The setting is complete and the H* LED turns off except in High alarm state.

*Replaced with '2' LED or '2' setpoint for the display-only type. With no alarm, this adjustment determines the position where the LED color changes.

• HH Setpoint Adjustment (for 4-point alarm output type only)

- 1) Press MODE key once or several times until HH LED starts blinking.
- 2) Press UP or DOWN keys until the digital meter shows a desired HH setpoint.
- 3) Press SET key. The setting is complete and the HH LED turns off except in HH alarm state.

• Analog/Digital Zero Adjustment (input sensitivity adjustment)

- 1) Apply a desired 0% input to the input terminals.
- 2) Press MODE key once or several times until ZERO LED starts blinking.
- 3) Press UP and DOWN keys at once. The ZERO LED now remains ON.
- 4) Press UP or DOWN keys until the digital meter shows a desired 0% value.
- 5) Press SET key. The setting is complete and the ZERO LED turns off.

• Analog/Digital Span Adjustment (input sensitivity adjustment)

- 1) Apply a desired 100% input to the input terminals.
- 2) Press MODE key once or several times until SPAN LED starts blinking.
- 3) Press UP and DOWN keys at once. The SPAN LED now remains ON.
- 4) Press UP or DOWN keys until the digital meter shows a desired 100% value.
- 5) Press SET key. The setting is complete and the SPAN LED turns off.

• Moving Average

The number of samples to be used for the moving average calculation can be selected among 1, 2, 4, 8 and 16.

- 1) Press MODE key once or several times until POINT LED starts blinking.
- 2) Press UP and DOWN keys at once. Now an 'A.' is shown at the left end of the digital meter.
- 3) Press UP or DOWN keys until the digital meter shows a desired number among 1, 2, 4, 8 and 16.
- 4) Press SET key. The setting is complete and the POINT LED turns off.

• Digital Display Read Rate

The digital display's read rate can be thinned out by one (80 msec.) to one-fifteenth (1200 msec.) against the unit's sampling rate. The bargraph read rate and the comparison rate of input signal against alarm setpoints is always 80 msec.

- 1) Press MODE key once or several times until POINT LED starts blinking.
- 2) Press UP and DOWN keys at once for twice. Now an 'r.' is shown at the left end of the digital meter.
- 3) Press UP or DOWN keys until the digital meter shows a desired number between 1 and 15. For example, setting '5' means that the digital display reading is changed once every 5 samplings; 80 msec. multiplied by 5 equals 400 msec.
- 4) Press SET key. The setting is complete and the POINT LED turns off.

• Digital Display for Negative Input

With this setting, you can specify either the digital display reading goes to negative or be fixed to zero for input signals below 0%.

- 1) Press MODE key once or several times until POINT LED starts blinking.
- 2) Press UP and DOWN keys at once for three times. Now an 'n.' is shown at the left end of the digital meter.
- 3) Press UP or DOWN keys and choose ON or OFF shown on the digital meter. When set to OFF, "0" is forcibly displayed if the value is negative. In this case, "Lo" is not displayed even if the input is below -10%. When set to ON, negative values are displayed as they are. The display shows negative value with ON setting, is fixed to zero with OFF setting.
- 4) Press SET key. The setting is complete and the POINT LED turns off.

• Bargraph Offset

The zero point on the bargraph can be shifted from the leftmost segment (0) up to the middle segment (50%) position.

- 1) Press MODE key once or several times until POINT LED starts blinking.
- 2) Press UP and DOWN keys at once for four times. Now a 'b.' is shown at the left end of the digital meter.
- 3) Press UP or DOWN keys until the digital meter shows a desired number between 0 (leftmost) and 25 (middle). One lighted segment on the bargraph indicates the selected point.
- 4) Press SET key. The setting is complete and the POINT LED turns off.

• Alarm Output Delay

Relay output can be turned ON with a delay after the alarm is tripped. Delay time can be specified between 0 and 15 seconds in 1-second increments, independently for each setpoint.

- 1) Press MODE key once or several times until the LED for the setpoint (HH, H, L, or LL) starts blinking.
- 2) Press UP and DOWN keys at once for twice. Now a 'c.' is shown at the left end of the digital meter.
- 3) Press UP or DOWN keys until the digital meter shows a desired number between 0 and 15 (seconds).
- 4) Press SET key. The setting is complete and the LED turns off except for normal alarm indicators.

• High or Low Trip

High or Low trip type can be specified for each alarm setpoint. For example, HH setpoint (High trip) can be changed to Low trip.

- 1) Press MODE key once or several times until the LED for the setpoint (HH, H, L, or LL) starts blinking.
- 2) Press UP and DOWN keys at once. Now a 'd.' is shown at the left end of the digital meter.
- 3) Press UP or DOWN keys and choose H (High) or L (Low) shown on the digital meter.
- 4) Press SET key. The setting is complete and the LED turns off except for normal alarm indicators.

[Notes]

ANALOG ZERO/SPAN ARE FACTORY CALIBRATED TO APPROPRIATE STATE. THERE USUALLY IS NO NEED OF ADJUSTMENT BUT IF YOU NEED TO DO SO, BE SURE TO USE PROPER CALIBRATION EQUIPMENT.

- 1) Go through zero/span adjustment and digital scaling before adjusting alarm setpoints.
- 2) For adjusting analog zero, input 0%. For span, input 100%.
- 3) Alarm setpoint data are stored in memory even when the power is removed.

ALARM TRIP OPERATION

Alarm Trip Operation Terminal No. in parentheses

• Alarm Output Code 2

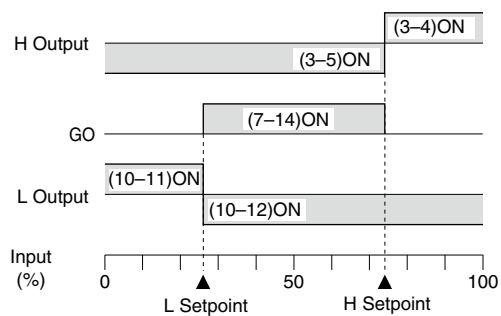

• Alarm Output Code 4

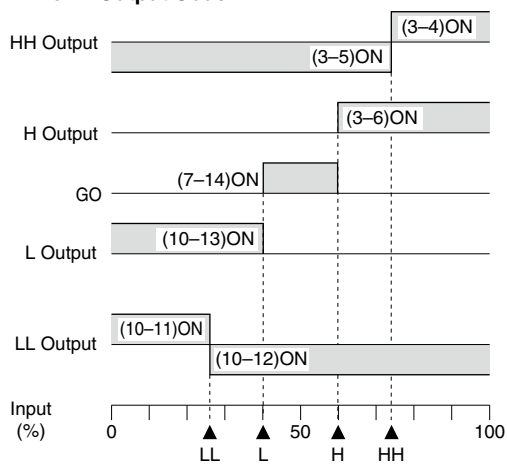

Terminals 3 – 5, 10 – 12 turn on at a loss of power.

LIGHTNING SURGE PROTECTION

We offer a series of lightning surge protector for protection against induced lightning surges. Please contact us to choose appropriate models.