

**BEFORE USE ....**

Thank you for choosing us. Before use, please check contents of the package you received as outlined below. If you have any problems or questions with the product, please contact our sales office or representatives.

**■ PACKAGE INCLUDES:**

Analog I/O module (body + base socket) .....(1)  
Terminating resistor (110 Ω, 0.25 W)..... (1)

**■ MODEL NO.**

Confirm Model No. marking on the product to be exactly what you ordered.

**■ INSTRUCTION MANUAL**

This manual describes necessary points of caution when you use this product, including installation, connection and basic maintenance procedures.

**POINTS OF CAUTION**

**■ POWER INPUT RATING & OPERATIONAL RANGE**

- Locate the power input rating marked on the product and confirm its operational range as indicated below:  
85 – 132V AC rating: 85 – 132V, 47 – 66 Hz, approx. 4VA  
24V DC rating: 24V ±10%, approx. 4W

**■ GENERAL PRECAUTIONS**

- Before you remove the unit from its base socket or mount it, turn off the power supply, input signal and output signal for safety.

**■ ENVIRONMENT**

- Indoor use.
- When heavy dust or metal particles are present in the air, install the unit inside proper housing with sufficient ventilation.
- Do not install the unit where it is subjected to continuous vibration. Do not subject the unit to physical impact.
- Environmental temperature must be within -5 to +55°C (23 to 131°F) with relative humidity within 30 to 90% RH in order to ensure adequate life span and operation.

**■ WIRING**

- Do not install cables close to noise sources (relay drive cable, high frequency line, etc.).
- Do not bind these cables together with those in which noises are present. Do not install them in the same duct.

**■ AND ....**

- The unit is designed to function as soon as power is supplied, however, a warm up for 10 minutes is required for satisfying complete performance described in the data sheet.

**INSTALLATION**

Detach the yellow clamps located at the top and bottom of the unit for separating the body from the base socket.

**■ DIN RAIL MOUNTING**

Set the base socket so that its DIN rail adaptor is at the bottom. Position the upper hook on the DIN rail and push in the lower. When removing the socket, push down the DIN rail adaptor utilizing a minus screwdriver and pull.

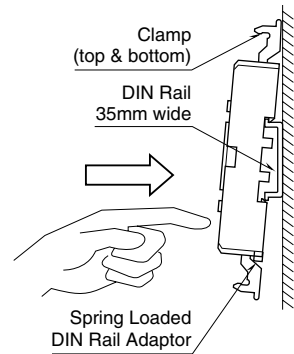

**■ WALL MOUNTING**

Refer to “EXTERNAL DIMENSIONS.”

Shape and size of the base socket are slightly different with various socket types.

## COMPONENT IDENTIFICATION

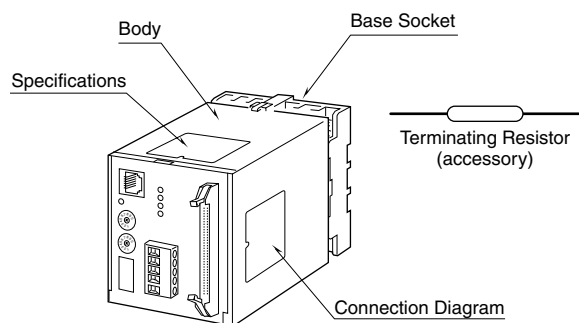

## FRONT PANEL CONFIGURATION

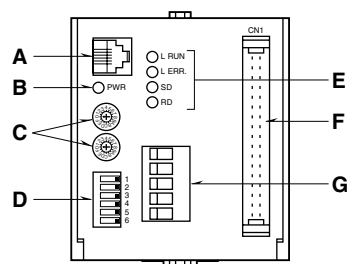

	NAME	FUNCTIONS																								
A	Modular jack for factory calibration	Used only for factory calibration.																								
B	Power indicator LED	Green LED, ON when power is supplied.																								
C	Node address setting	Selectable within 01 – F7. (factory set to: 00)																								
D	Transmission setting	<table border="1"> <thead> <tr> <th rowspan="2">SW</th> <th colspan="4">BAUD RATE (bps)</th> </tr> <tr> <th>38.4 k</th> <th>19.2 k</th> <th>9600</th> <th>4800</th> </tr> </thead> <tbody> <tr> <td>1</td> <td>ON</td> <td>OFF</td> <td>ON</td> <td>OFF</td> </tr> <tr> <td>2</td> <td>ON</td> <td>ON</td> <td>OFF</td> <td>OFF</td> </tr> <tr> <td>3</td> <td>OFF</td> <td>OFF</td> <td>OFF</td> <td>OFF</td> </tr> </tbody> </table>	SW	BAUD RATE (bps)				38.4 k	19.2 k	9600	4800	1	ON	OFF	ON	OFF	2	ON	ON	OFF	OFF	3	OFF	OFF	OFF	OFF
		SW		BAUD RATE (bps)																						
			38.4 k	19.2 k	9600	4800																				
		1	ON	OFF	ON	OFF																				
		2	ON	ON	OFF	OFF																				
		3	OFF	OFF	OFF	OFF																				
		<table border="1"> <thead> <tr> <th rowspan="2">SW</th> <th colspan="4">PARITY</th> </tr> <tr> <th>NONE</th> <th>ODD</th> <th>EVEN</th> <th>N/A</th> </tr> </thead> <tbody> <tr> <td>4</td> <td>ON</td> <td>OFF</td> <td>ON</td> <td>OFF</td> </tr> <tr> <td>5</td> <td>ON</td> <td>ON</td> <td>OFF</td> <td>OFF</td> </tr> </tbody> </table>	SW	PARITY				NONE	ODD	EVEN	N/A	4	ON	OFF	ON	OFF	5	ON	ON	OFF	OFF					
SW	PARITY																									
	NONE	ODD	EVEN	N/A																						
4	ON	OFF	ON	OFF																						
5	ON	ON	OFF	OFF																						
<table border="1"> <thead> <tr> <th rowspan="2">SW</th> <th colspan="2">DATA</th> </tr> <tr> <th>RTU (Binary)</th> <th>ASCII</th> </tr> </thead> <tbody> <tr> <td>6</td> <td>ON</td> <td>OFF</td> </tr> </tbody> </table>	SW	DATA		RTU (Binary)	ASCII	6	ON	OFF																		
SW		DATA																								
	RTU (Binary)	ASCII																								
6	ON	OFF																								
E	Status indicator LED	MARKING (color)																								
		L RUN (red)	ON for 10 sec. when the modules receives data.																							
		L ERR. (red)	ON at errors in parity, framing, overrun, CRC, LRC																							
		SD (red)	ON when transmitting																							
F	I/O connector	RD (red)	ON when receiving																							
F	I/O connector	For input and output signals																								
G	Euro type connector terminal for Modbus	For wiring to Modbus																								

## TERMINAL CONNECTIONS

Connect the unit as in the diagram below or refer to the connection diagram on the side of the unit.

### EXTERNAL DIMENSIONS unit: mm (inch)

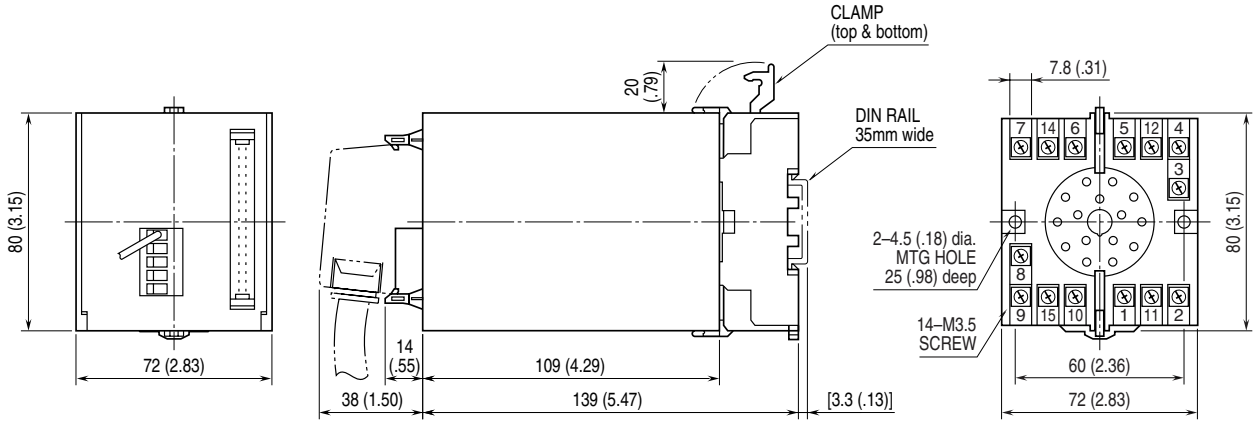

•When mounting, no extra space is needed between units.

### CONNECTION DIAGRAM

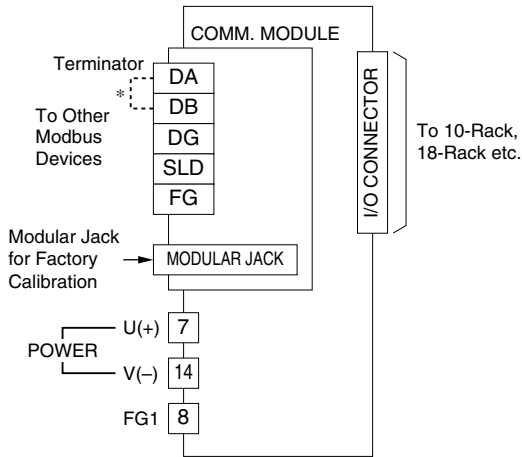

\* Attach the terminating resistor when the module is at the termination of a transmission line.

## COMMUNICATION CABLE CONNECTIONS

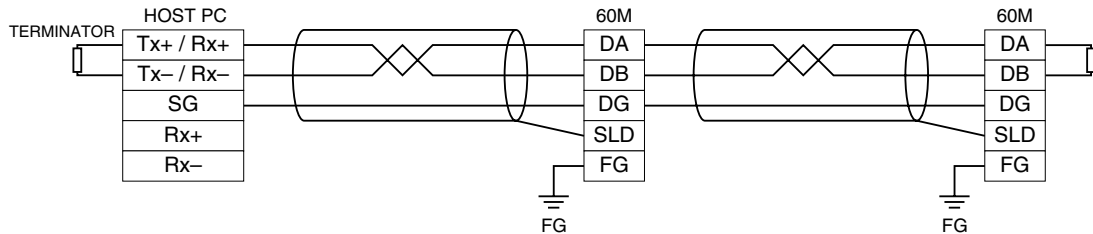

## MODBUS FUNCTION CODES & SUPPORTED CODES

### ■ Data and Control Functions

CODE	NAME		
01	Read Coil Status	X	Digital output from the slave
02	Read Input Status	X	Status of digital inputs to the slave
03	Read Holding Registers	X	General purpose register within the slave
04	Read Input Registers	X	Collected data from the field by the slave
05	Force Single Coil	X	Digital output from the slave
06	Preset Single Registers	X	General purpose register within the slave
07	Read Exception Status		
08	Diagnostics	X	
09	Program 484		
10	Poll 484		
11	Fetch Comm. Event Counter		Fetch a status word and an event counter
12	Fetch Comm. Event Log		A status word, an event counter, a message count and a field of event bytes
13	Program Controller		
14	Poll Controller		
15	Force Multiple Coils	X	Digital output from the slave
16	Preset Multiple Registers	X	General purpose register within the slave
17	Report Slave ID		Slave type / 'RUN' status
18	Program 884/M84		
19	Reset Comm. Link		
20	Read General Reference		
21	Write General Reference		
22	Mask Write 4X Register		
23	Read/Write 4X Register		
24	Read FIFO Queue		

### ■ Exception Codes

CODE	NAME		
01	Illegal Function	X	Function code is not allowable for the slave
02	Illegal Data Address	X	Address is not available within the slave
03	Illegal Data Value	X	Data is not valid for the function
04	Slave Device Failure		
05	Acknowledge		
06	Slave Device Busy		
07	Negative Acknowledge		
08	Memory Parity Error		

### ■ Diagnostic Subfunctions

CODE	NAME		
00	Return Query Data	X	Loop back test
01	Restart Comm. Option	X	Reset the slave and clear all counters
02	Return Diagnostic Register	X	Contents of the diagnostic data (2 bytes)
03	Change ASCII Input Delimiter	X	Delimiter character of ASCII message
04	Force Listen Only Mode	X	Force the slave into Listen Only Mode

## MODBUS I/O ASSIGNMENTS

	ADDRESS	60M TYPE		DATA TYPE	DATA
		1	2		
Coil (0X)	1 – 16	X			Averaging SW *
	17 – 32	X			Sampling rate SW **
Inputs (1X)	1 – 16	X	X		Analog channel status (active channel)
	17 – 32	X	X		Analog status (out of range)
Input Registers (3X)	1 – 16	X		I	Analog input
	17 – 48	X		F	Analog input
Holding Registers (4X)	1 – 16		X	I	Analog output
	17 – 48		X	F	Analog output
	49 – 80	X	X	F	Full scale
	81 – 112	X	X	F	Zero scale

### ■ 60M Type

1: Analog input

2: Analog output

### ■ Data Type

F: Floating

I : Int 0 – 10000 (0 – 100%)

\* Averaging SW

1: 4 samples

2: 2 samples

3: None

\*\* Sampling rate SW

17: 400 millisecc.

18: 240 millisecc.

19: 160 millisecc.

## I/O CONNECTOR PIN ASSIGNMENTS (34 pins)

### ■ INPUT CONNECTOR

PIN NO.	ASSIGNMENT	PIN NO.	ASSIGNMENT
1	Input 1	2	COM
3	Input 2	4	COM
5	Input 3	6	COM
7	Input 4	8	COM
9	Input 5	10	COM
11	Input 6	12	COM
13	Input 7	14	COM
15	Input 8	16	COM
17	Input 9	18	COM
19	Input 10	20	COM
21	Input 11	22	COM
23	Input 12	24	COM
25	Input 13	26	COM
27	Input 14	28	COM
29	Input 15	30	COM
31	Input 16	32	COM
33	No connection	34	No connection

### ■ OUTPUT CONNECTOR

PIN NO.	ASSIGNMENT	PIN NO.	ASSIGNMENT
1	Output 1	2	COM
3	Output 2	4	COM
5	Output 3	6	COM
7	Output 4	8	COM
9	Output 5	10	COM
11	Output 6	12	COM
13	Output 7	14	COM
15	Output 8	16	COM
17	Output 9	18	COM
19	Output 10	20	COM
21	Output 11	22	COM
23	Output 12	24	COM
25	Output 13	26	COM
27	Output 14	28	COM
29	Output 15	30	COM
31	Output 16	32	COM
33	No connection	34	No connection

## CABLE (MODEL: MCN34) PIN ASSIGNMENTS

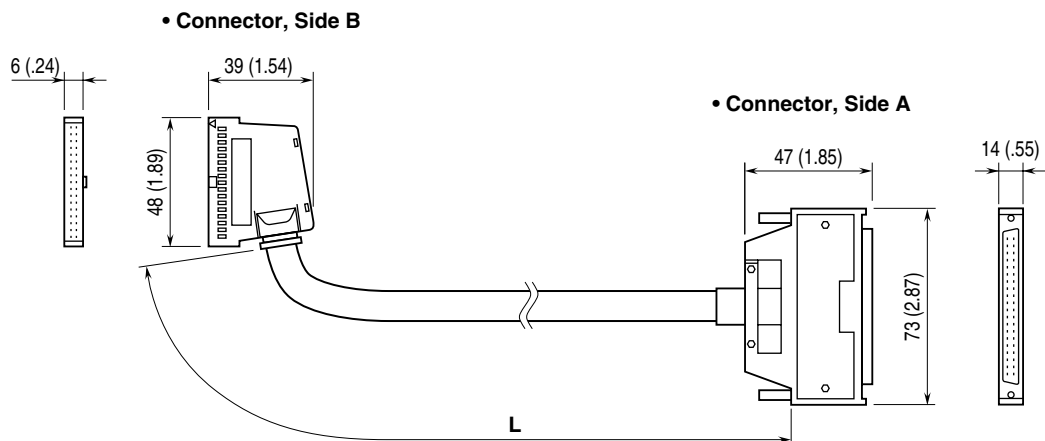

	MCN34-03	MCN34-05	MCN34-10	MCN34-30
<b>L</b>	30 cm (11.8 in.)	50 cm (19.7 in.)	1 m (3.3 ft.)	3 m (9.8 ft.)

### ■ CONNECTOR PIN ASSIGNMENT

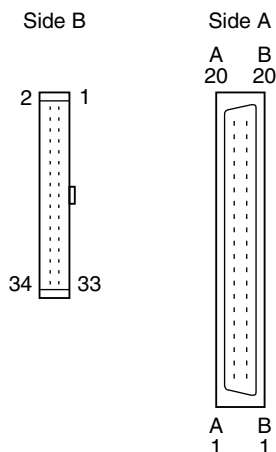

### ■ WIRING DIAGRAM

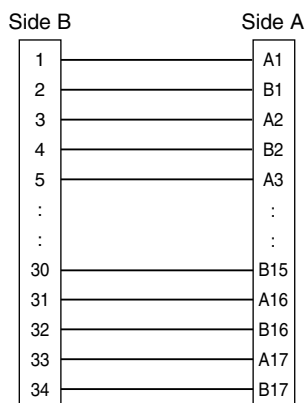

Pins No. A18 – B20 on Side A are not connected.

## WIRING INSTRUCTIONS

### ■ SCREW TERMINAL

Torque: 0.8 N·m

### ■ EURO TYPE CONNECTOR TERMINAL (Modbus)

Applicable wire size: 0.2 to 2.5 mm<sup>2</sup> (AWG24 to 12)

Stripped length: 7 mm

## LIGHTNING SURGE PROTECTION

We offer a series of lightning surge protectors for protection against induced lightning surges. Please contact us to choose appropriate models.