

REMOTE I/O INTERFACE UNIT
each 8 points of analog & digital I/O

model **DLC-□S1**

Thank you for choosing us. Before use, check specifications on the unit label.

If you have any problems or questions with the product, please contact our sales office or representatives.

General Description

The Model DLC-□ S1 accepts 8-channel analog and digital inputs and provides 8-channel digital and analog outputs.

Installation [mm (inch)]

- Operating temperature: -5 to +50°C (23 to 122°F)
 - Operating humidity: 30 to 90% RH (non-condensing)
- Keep away from water, corrosive gas, dust and vibration.

■SURFACE MOUNTING

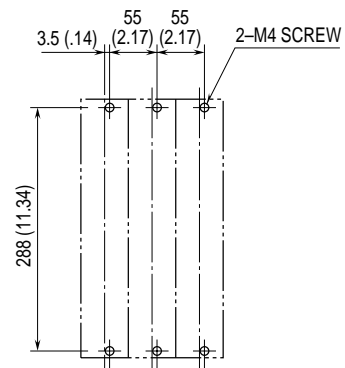

■SIDE MOUNTING (terminal block at the right side)

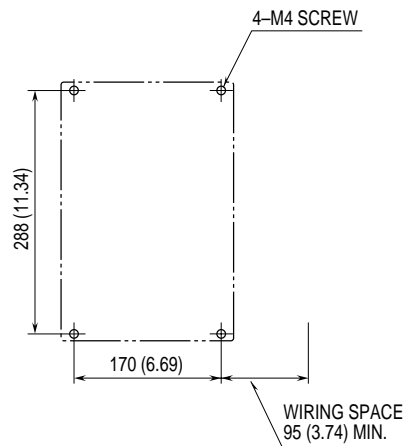

Front Panel Configuration

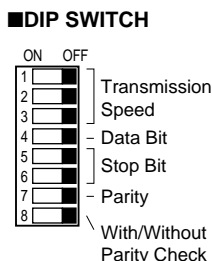
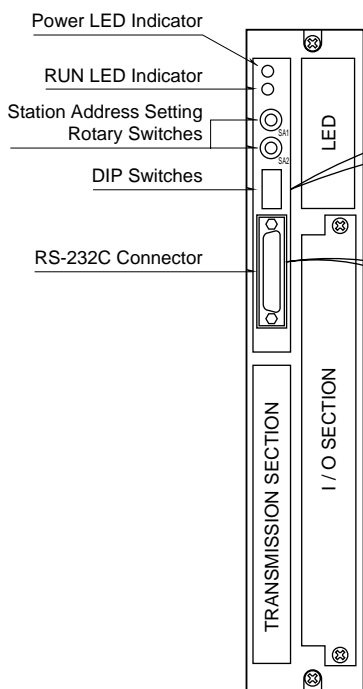

SWITCH NO.	TRANSMISSION SPEED (bps)					
	300	600	1200	2400	4800	9600
1	OFF	OFF	OFF	OFF	ON	ON
2	OFF	OFF	ON	ON	OFF	OFF
3	OFF	OFF	OFF	ON	OFF	ON

SWITCH NO.	7 BITS	8 BITS
4	OFF	ON

SWITCH NO.	1	1.5	2
5	OFF	ON	ON
6	ON	OFF	ON

SWITCH NO.	ODD	EVEN
7	OFF	ON

SWITCH NO.	WITH	W/O
8	OFF	ON

■D-SUB CONNECTOR PIN ASSIGNMENT

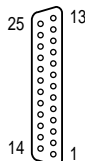

•RS-232C Connection Example (cross type cable)

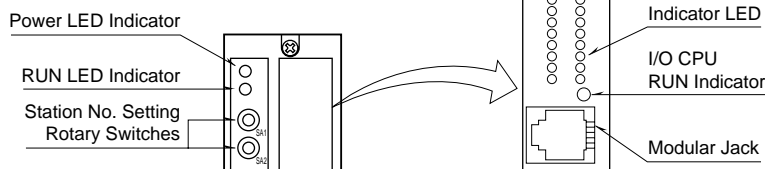
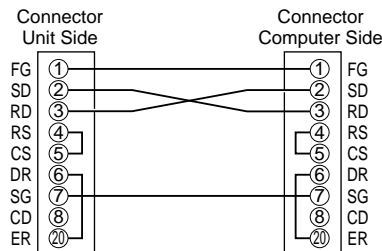

■TWISTED-PAIR

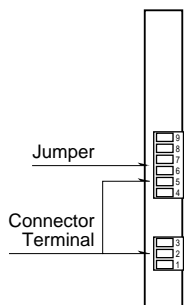

■FIBER OPTICS

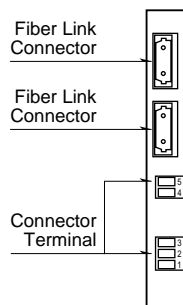

■TWISTED-PAIR & FIBER

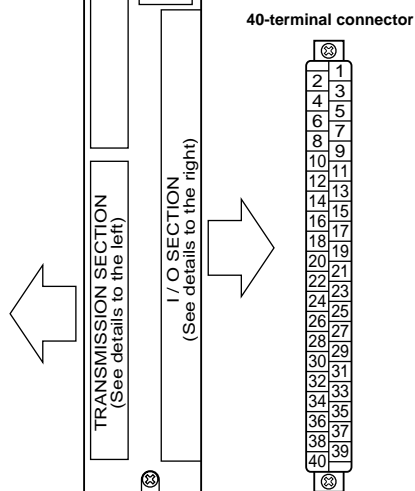
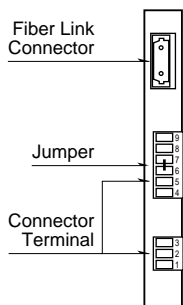

Terminal Connections

Make wiring to terminals as shown in the figure below.
 Refer also to Technical Information [DLC RS-232C INTERFACE].

Transmission & Power Connection

■TWISTED-PAIR CABLE
 (transmission media code: 1)

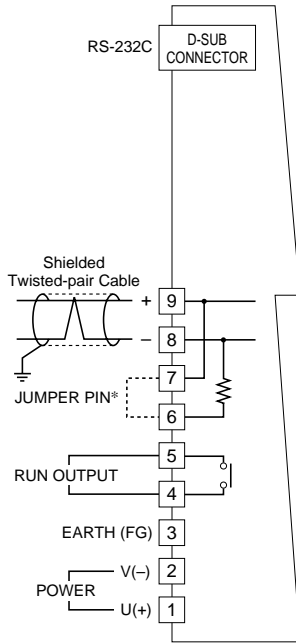

■FIBER OPTICS CABLE
 (transmission media code: 2)

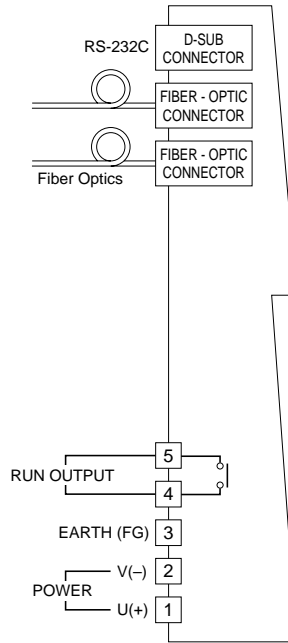

■TWISTED-PAIR & FIBER OPTICS
 (transmission media code: 7)

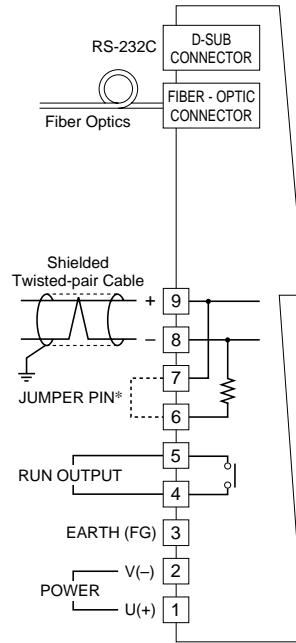

*When the unit is located at the end of transmission line via twisted-pair cable (= no cross-wiring), short across the terminals 6 – 7 with the jumper pin (or wire) provided with the unit. Remove the jumper pin for the one not located at the end.

I/O Terminal Connection

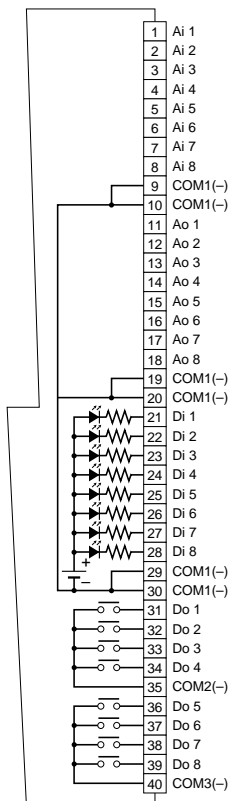

Terminal assignment: See Figure A-2 in the specification sheet.

• Connecting to the Power Source

For models DLC-xS1-K or -L, connect an AC supply source across the terminal U and V.

For models DLC-xS1-S or -R, connect a DC supply source across the terminal U(+) and V(-).

• Twisted-Pair Cable

- 1) Use a cable at the minimum of 0.9 mm diameter.
- 2) Connect between the LINE terminal (+) and (+), (-) and (-) of the corresponding units.
- 3) Install transmission cables in a general instrumentation cable pit or rack, separate from those for power supply cables, in order to prevent noise interference.

• Fiber Optics

- 1) Connect a fiber link connector to Fiber Link terminal.
- 2) Observe an enough radius when bending fiber optics cables.
- 3) Follow installation instructions by the cable manufacturer.

• DIN Terminals

Power supply, twisted-pair cable transmission line, RUN output are connected at the DIN terminal block.

The terminal block is composed of the base connector and the removable plug. Clamp the cable with the screw in the clamping unit. Solid cables must be with a pin terminal. Stranded cables must be of 1.4 mm dia. at the maximum. DO NOT solder wires in stranded cables.

• Wiring Procedure for Terminal Block

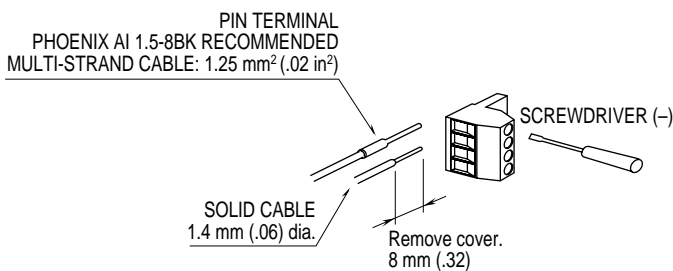

Terminating Resistor

A transmission line via twisted-pair cables needs to have terminating resistors in order to prevent the transmission waveform from reflecting at the ends of the line.

Each DLC unit incorporates a terminating resistor which is connected with a jumper across the terminating resistor terminals. When the system is composed of three or more units, remove the jumper from those which are not at the both ends of transmission line in order to disconnect the terminating resistors.

Station Address

Station number (Station Address = SA) is selectable with the front accessed DIP rotary switches (SA1 and SA2), from 00H to FFH.

Assign an even number to one unit and assign the consecutive one to the paired unit.

For example, assign "02" and "03," or "1A" and "1B."

More than two units cannot be paired.

Checking

- 1) Check that all cables are correctly wired according to the connection diagram. Check polarity of the transmission cables and power supply cables.
- 2) Check Station Address.
- 3) Terminating resistor (required only for units at the both ends of transmission line)
- 4) Check the I/O signals.

Lightning Surge Protection

In order to prevent lightning surges entering through power supply line and signal line, proper surge protection will be required. Specify our M-RESTER Series Lightning Surge Protectors.