

**DC/FREQUENCY CONVERTER**  
(selectable range)

MODEL

**KAPU**

**BEFORE USE ....**

Thank you for choosing us. Before use, please check contents of the package you received as outlined below. If you have any problems or questions with the product, please contact our sales office or representatives.

**■ PACKAGE INCLUDES:**

Signal conditioner  
(body + base socket + input resistor) .....(1)  
Input resistor is provided only with current input type.

**■ MODEL NO.**

Confirm Model No. marking on the product to be exactly what you ordered.

**■ INSTRUCTION MANUAL**

This manual describes necessary points of caution when you use this product, including installation, connection and basic maintenance procedures.

**POINTS OF CAUTION**

**■ POWER INPUT RATING & OPERATIONAL RANGE**

- Locate the power input rating marked on the product and confirm its operational range as indicated below:  
**AC power:** Rating  $\pm 10\%$ , 50/60  $\pm 2$  Hz, approx. 2VA  
**DC power:** Rating  $\pm 10\%$ , approx. 2W

**■ GENERAL PRECAUTIONS**

- Before you remove the unit from its base socket or mount it, turn off the power supply and input signal for safety.

**■ ENVIRONMENT**

- Indoor use.
- When heavy dust or metal particles are present in the air, install the unit inside proper housing with sufficient ventilation.
- Do not install the unit where it is subjected to continuous vibration. Do not subject the unit to physical impact.
- Environmental temperature must be within  $-5$  to  $+55^{\circ}\text{C}$  ( $23$  to  $131^{\circ}\text{F}$ ) with relative humidity within 30 to 90% RH in order to ensure adequate life span and operation.

**■ WIRING**

- Do not install cables close to noise sources (relay drive cable, high frequency line, etc.).
- Do not bind these cables together with those in which noises are present. Do not install them in the same duct.

**■ AND ....**

- The unit is designed to function as soon as power is supplied, however, a warm up for 10 minutes is required for satisfying complete performance described in the data sheet.

**COMPONENT IDENTIFICATION**

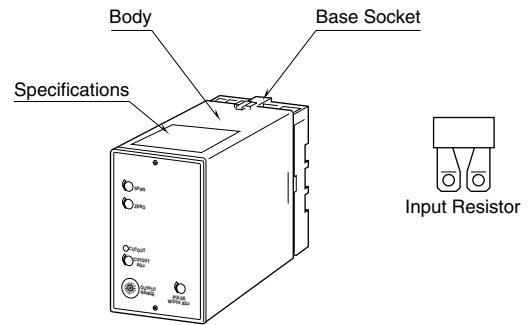

**INSTALLATION**

Detach the yellow clamps located at the top and bottom of the unit for separate the body from the base socket.

**■ DIN RAIL MOUNTING**

Set the base socket so that its DIN rail adaptor is at the bottom. Hang the upper hook at the rear side of base socket on the DIN rail and push in the lower. When removing the socket, push down the DIN rail adaptor utilizing a minus screwdriver and pull.

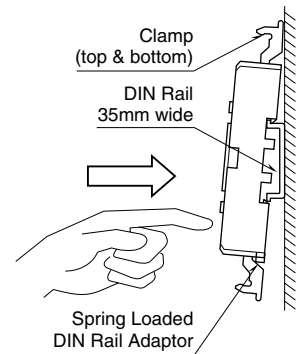

**■ WALL MOUNTING**

Refer to "EXTERNAL DIMENSIONS."

Shape and size of the base socket are slightly different with various socket types.

## TERMINAL CONNECTIONS

Connect the unit as in the diagram below or refer to the connection diagram on the front of the unit.

When an input resistor is provided with the module, attach it together with input wiring to the input screw terminals.

### EXTERNAL DIMENSIONS unit: mm (inch)

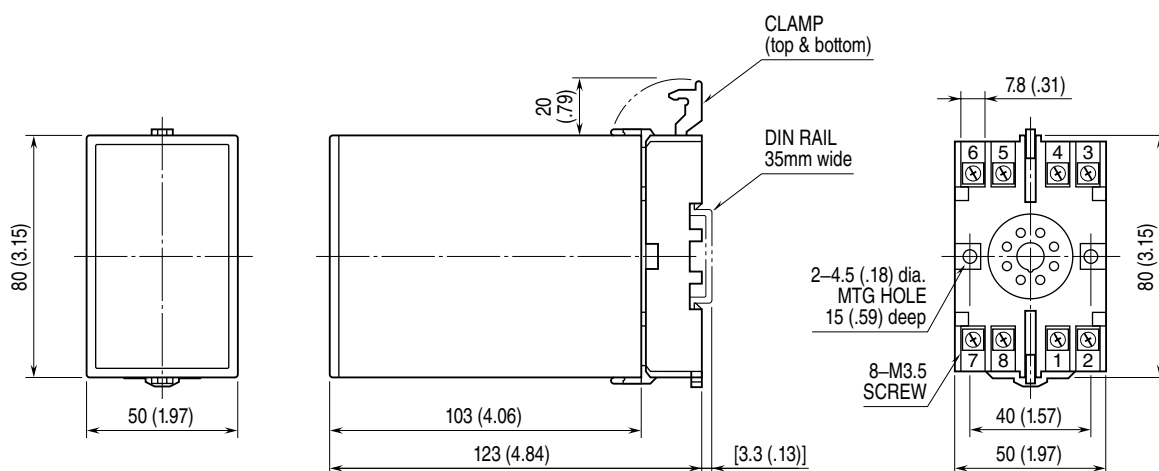

• When mounting, no extra space is needed between units.

### CONNECTION DIAGRAM

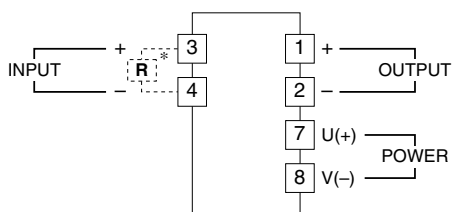

\*Input shunt resistor attached for current input.

### TERMINAL ASSIGNMENTS unit: mm (inch)

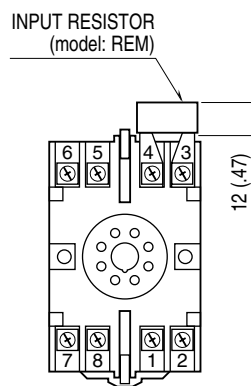

Input shunt resistor attached for current input.

### Output Connection Examples

#### Open Collector

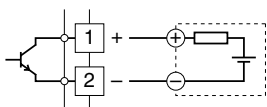

#### Relay Contact

##### •AC Powered

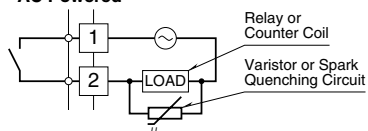

#### Voltage Pulse

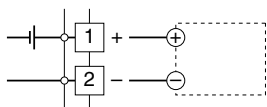

##### •DC Powered

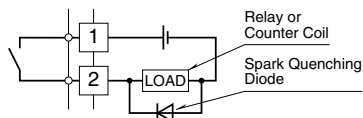

## CHECKING

- 1) Terminal wiring: Check that all cables are correctly connected according to the connection diagram.
- 2) Power input voltage: Check voltage across the terminal 7 – 8 with a multimeter.
- 3) Input: Check that the input signal is within 0 – 100% of the full-scale.
- 4) Output: Check that the load resistance meets the described specifications shown below.

OUTPUT	LOAD REQUIREMENTS
Open collector	50V DC @50mA max.
Relay contact	120V AC @200mA max. (cos $\phi$ =1) 24V DC @200mA max. (resistive load)
5V pulse	600 $\Omega$ min.
24V pulse	800 $\Omega$ min.

## ADJUSTMENT PROCEDURE

This unit is calibrated at the factory to meet the ordered specifications, therefore you usually do not need any calibration.

For matching the signal to a receiving instrument or in case of regular calibration, adjust the output as explained in the following.

### ■ HOW TO CALIBRATE THE OUTPUT SIGNAL

Connect a signal generator to the input terminal and a frequency counter to the output terminal.

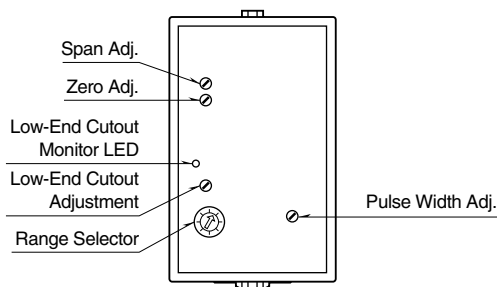

### • Output Range Adjustment (coarse range)

- 1) Select an appropriate coarse range in the table to the right, and set the front accessed Range Selector.

### • Zero/Span Adjustments

- 1) First nullify Low-end Cutout Adj. to 0%.
- 2) ZERO (fine range): Apply 5% input and adjust output to 5%.
- 2) SPAN (fine range): Apply full-scale (100%) input and adjust output to 100%.
- 3) Check ZERO adjustment again with 5% input.
- 4) When ZERO value is changed, repeat the above procedure 1) – 3).

Note: The output frequency is precisely doubled by turning Range Selector by 1 division to the counterclockwise direction. In order to quickly make low frequency range adjustments, conduct fine adjustment first with a higher coarse range, and then change coarse range to the actual one.

### • Low-end Cutout Adjustment

- 1) Apply the desired input to be eliminated.
- 2) Turn the Low-end Cutout Adj. clockwise until the Cutout LED is turned on.
- 3) Turn it slowly counterclockwise to the exact position where the Cutout LED is still on but will be turned off if it turned further counterclockwise.

### • Output Pulse Width Adjustment

The pulse width is adjusted at the factory until the duty ratio becomes 50% of the maximum frequency. If this value lies outside of the adjustable range, either maximum or minimum selectable value will be used.

If the pulse width needs to be changed, go through the following procedures.

- 1) Turn the Pulse Width Adj. fully counterclockwise.
- 2) Apply 100% input and turn it slowly clockwise until the output device (e.g. counter) operates.

### ■ FREQUENCY RANGES

#### • Open Collector, 5V Pulse

SW No.	SPAN RANGE	
	MIN. (50%)	MAX. (100%)
0	0 – 5 kHz	0 – 10 kHz
1	0 – 2.5 kHz	0 – 5 kHz
2	0 – 1.25 kHz	0 – 2.5 kHz
3	0 – 625 Hz	0 – 1.25 kHz
4	0 – 312 Hz	0 – 625 Hz
5	0 – 156 Hz	0 – 312 Hz
6	0 – 78 Hz	0 – 156 Hz
7	0 – 39 Hz	0 – 78 Hz
8	0 – 20 Hz	0 – 39 Hz
9	0 – 10 Hz	0 – 20 Hz
A	0 – 5 Hz	0 – 10 Hz
B	0 – 2.5 Hz	0 – 5 Hz
C	0 – 1.25 Hz	0 – 2.5 Hz
D	0 – 36 pulses/min.	0 – 1.25 Hz
E	0 – 18 pulses/min.	0 – 36 pulses/min.
F	0 – 9 pulses/min.	0 – 18 pulses/min.

#### • Middle Range Frequency Open Collector & 5V Pulse

SW No.	SPAN RANGE	
	MIN. (50%)	MAX. (100%)
0	Not Used	Not Used
1	Not Used	Not Used
2	Not Used	Not Used
3	Not Used	Not Used
4	Not Used	Not Used
5	0 – 156 Hz	0 – 312 Hz
6	0 – 78 Hz	0 – 156 Hz
7	0 – 39 Hz	0 – 78 Hz
8	0 – 20 Hz	0 – 39 Hz
9	0 – 10 Hz	0 – 20 Hz
A	0 – 5 Hz	0 – 10 Hz
B	0 – 2.5 Hz	0 – 5 Hz
C	0 – 1.25 Hz	0 – 2.5 Hz
D	0 – 36 pulses/min.	0 – 1.25 Hz
E	0 – 18 pulses/min.	0 – 36 pulses/min.
F	0 – 9 pulses/min.	0 – 18 pulses/min.

• Relay Contact, Low-Freq. Open Collector & 5V Pulse, 24V Pulse

SW No.	SPAN RANGE	
	MIN. (50%)	MAX. (100%)
0	0 – 65 pulses/min.	0 – 130 pulses/min.
1	0 – 32 pulses/min.	0 – 65 pulses/min.
2	0 – 16 pulses/min.	0 – 32 pulses/min.
3	0 – 8 pulses/min.	0 – 16 pulses/min.
4	0 – 4 pulses/min.	0 – 8 pulses/min.
5	0 – 2 pulses/min.	0 – 4 pulses/min.
6	0 – 1 pulses/min.	0 – 2 pulses/min.
7	0 – 0.5 pulses/min.	0 – 1 pulses/min.
8	0 – 0.25 pulses/min.	0 – 0.5 pulses/min.
9	0 – 8 pulses/hour	0 – 0.25 pulses/min.
A	0 – 4 pulses/hour	0 – 8 pulses/hour
B	0 – 2 pulses/hour	0 – 4 pulses/hour
C	0 – 1 pulses/hour	0 – 2 pulses/hour
D	0 – 0.5 pulses/hour	0 – 1 pulses/hour
E	0 – 0.24 pulses/hour	0 – 0.5 pulses/hour
F	0 – 0.12 pulses/hour	0 – 0.24 pulses/hour

## MAINTENANCE

Regular calibration procedure is explained below:

### ■ CALIBRATION

Warm up the unit for at least 10 minutes. Apply 0%, 5%, 25%, 50%, 75% and 100% input signal. Check that the output signal for the respective input signal remains within accuracy described in the data sheet. When the output is out of tolerance, recalibrate the unit according to the “ADJUSTMENT PROCEDURE” explained earlier.

## LIGHTNING SURGE PROTECTION

We offer a series of lightning surge protector for protection against induced lightning surges. Please contact us to choose appropriate models.