

FREQUENCY TRANSMITTER
(selectable range)

MODEL

KPAU**BEFORE USE**

Thank you for choosing us. Before use, please check contents of the package you received as outlined below.

If you have any problems or questions with the product, please contact our sales office or representatives.

■ PACKAGE INCLUDES:

Signal conditioner (body + base socket).....(1)

■ MODEL NO.

Confirm Model No. marking on the product to be exactly what you ordered.

■ INSTRUCTION MANUAL

This manual describes necessary points of caution when you use this product, including installation, connection and basic maintenance procedures.

POINTS OF CAUTION**■ CONFORMITY WITH EU DIRECTIVES**

- This equipment is suitable for Pollution Degree 2 and Installation Category II (transient voltage 2500V). Reinforced insulation (signal input or output to power input: 300V) and basic insulation (signal input to output: 300V) are maintained. Prior to installation, check that the insulation class of this unit satisfies the system requirements.
- Insert a noise filter for the input and output connected to the unit. TDK Model ZCAT 3035-1330 or equivalent is recommended.
- Altitude up to 2000 meters.
- The equipment must be mounted inside a panel.
- The equipment must be installed such that appropriate clearance and creepage distances are maintained to conform to CE requirements. Failure to observe these requirements may invalidate the CE conformance.
- The actual installation environments such as panel configurations, connected devices, connected wires, may affect the protection level of this unit when it is integrated in a panel system. The user may have to review the CE requirements in regard to the whole system and employ additional protective measures to ensure the CE conformity.
- Install lightning surge protectors for those wires connected to remote locations.

■ POWER INPUT RATING & OPERATIONAL RANGE

- Locate the power input rating marked on the product and confirm its operational range as indicated below:
AC power: Rating $\pm 10\%$, 50/60 ± 2 Hz, approx. 4VA
DC power: Rating $\pm 10\%$, approx. 2.5W

■ GENERAL PRECAUTIONS

- Before you remove the unit from its base socket or mount it, turn off the power supply and input signal for safety.

■ ENVIRONMENT

- Indoor use.
- When heavy dust or metal particles are present in the air, install the unit inside proper housing with sufficient ventilation.
- Do not install the unit where it is subjected to continuous vibration. Do not subject the unit to physical impact.
- Environmental temperature must be within -5 to $+55^{\circ}\text{C}$ (23 to 131°F) with relative humidity within 30 to 90% RH in order to ensure adequate life span and operation.

■ WIRING

- Do not install cables close to noise sources (relay drive cable, high frequency line, etc.).
- Do not bind these cables together with those in which noises are present. Do not install them in the same duct.

■ AND

- The unit is designed to function as soon as power is supplied, however, a warm up for 10 minutes is required for satisfying complete performance described in the data sheet.

COMPONENT IDENTIFICATION

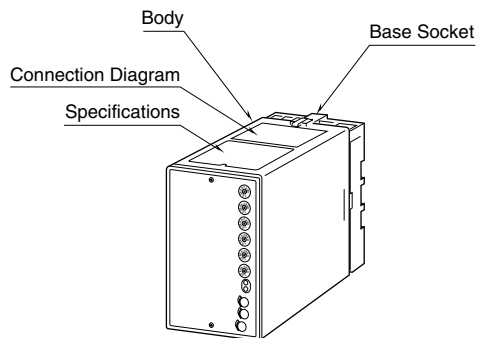

FRONT PANEL CONFIGURATION

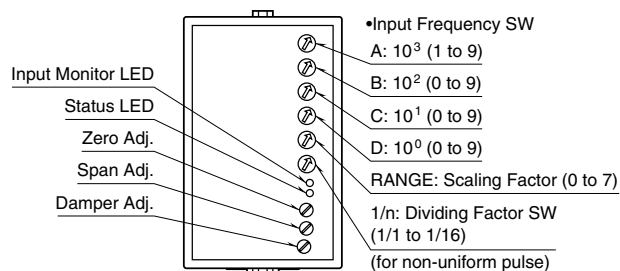

• Input Frequency SW

Choose a frequency range from the table below and set the Scaling Factor SW. Set 10^3 (MSB) through 10^0 (LSB) switches respectively to match each digit of the input frequency.

SCALING FACTOR SW	FREQUENCY RANGE
0	10.00 – 99.99 kHz
1	1.000 – 9.999 kHz
2	100.0 – 999.9 Hz
3	10.00 – 99.99 Hz
4	1.000 – 9.999 Hz
5	100.0 – 999.9 mHz
6	10.00 – 99.99 mHz
7	1.000 – 9.999 mHz
8	Not used
9	Not used

[example] 497.0 Hz

Scaling factor SW = 2 (100.0 – 999.9 Hz)

10^3 SW = 4, 10^2 SW = 9, 10^1 SW = 7, 10^0 SW = 0

• Dividing Factor SW

Non-uniform input pulses are divided and then multiplied for stabilizing the output. The SW is used to set the dividing factor. The overall step response time (0 – 90%) equals 0.5 sec. + 1 pulse cycle after the dividing.

• Input Monitor LED

Red LED blinks according to the input.

• Status LED

Green LED turns ON with normal operating conditions.

• Damper Adj.

The trimmer is used to set a time constant to provide a first order lag output. Turning the trimmer clockwise increases the time constant, while turning it counterclockwise decreases the constant. Adjustable within approx. 0.5 to 5 sec.

• Transmitter Operation after Changing Setting

The unit starts providing accurate output in three pulses after the input frequency has been changed.

INSTALLATION

Detach the yellow clamps located at the top and bottom of the unit for separate the body from the base socket.

■ DIN RAIL MOUNTING

Set the base socket so that its DIN rail adaptor is at the bottom. Hang the upper hook at the rear side of base socket on the DIN rail and push in the lower. When removing the socket, push down the DIN rail adaptor utilizing a minus screwdriver and pull.

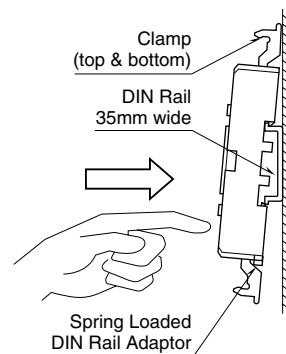

■ WALL MOUNTING

Refer to “EXTERNAL DIMENSIONS.”

Shape and size of the base socket are slightly different with various socket types.

TERMINAL CONNECTIONS

Connect the unit as in the diagram below or refer to the connection diagram on the top of the unit.

EXTERNAL DIMENSIONS unit: mm (inch)

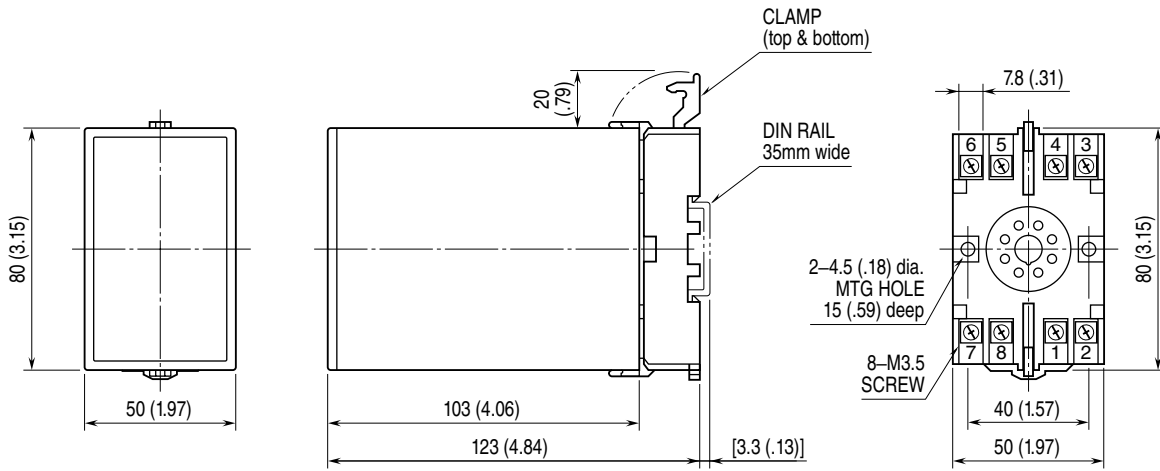

• When mounting, no extra space is needed between units.

CONNECTION DIAGRAM

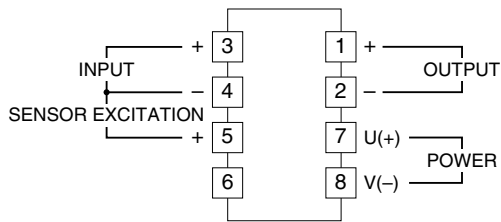

Input Connection Examples

Open Collector or Mechanical Contact

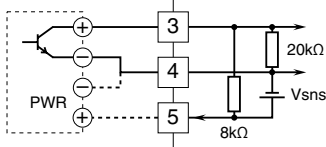

2-Wire Current Pulse

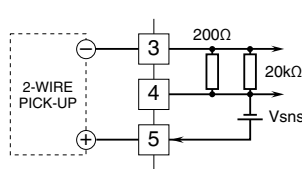

Voltage Pulse or Proximity Sensor

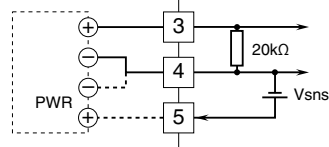

CHECKING

- 1) Terminal wiring: Check that all cables are correctly connected according to the connection diagram.
- 2) Power input voltage: Check voltage across the terminal 7 – 8 with a multimeter.
- 3) Input: Check that appropriate voltage is measured across the terminal 3 (+) – 4 (–) on an oscilloscope. ($L \leq 1V$, $H \geq 2V$; voltage pulse)
- 4) Output: Check that the load resistance meets the described specifications.

ADJUSTMENT PROCEDURE

This unit is calibrated at the factory to meet the ordered specifications, therefore you usually do not need any calibration.

For matching the signal to a receiving instrument or in case of regular calibration, adjust the output as explained in the following.

■ HOW TO CALIBRATE THE OUTPUT SIGNAL

Use a signal source and measuring instruments of sufficient accuracy level. Turn the power supply on and warm up for more than 10 minutes.

- 1) ZERO: Apply 10% input and adjust output to 10%.
- 2) SPAN: Apply 100% input and adjust output to 100%.
- 3) Check ZERO adjustment again with 10% input.
- 4) When ZERO value is changed, repeat the above procedure 1) – 3).

MAINTENANCE

Regular calibration procedure is explained below:

■ CALIBRATION

Warm up the unit for at least 10 minutes. Apply 10%, 25%, 50%, 75% and 100% input signal. Check that the output signal for the respective input signal remains within accuracy described in the data sheet. When the output is out of tolerance, recalibrate the unit according to the “ADJUSTMENT PROCEDURE” explained earlier.

LIGHTNING SURGE PROTECTION

We offer a series of lightning surge protector for protection against induced lightning surges. Please contact us to choose appropriate models.