

**DC ALARM**  
(rotary switch adjustment)

MODEL **KSL-x5**

**BEFORE USE ....**

Thank you for choosing us. Before use, please check contents of the package you received as outlined below. If you have any problems or questions with the product, please contact our sales office or representatives.

**■ PACKAGE INCLUDES:**

DC alarm (body + base socket + input resistor) .....(1)  
Input resistor is provided only with current input type.

**■ MODEL NO.**

Confirm Model No. marking on the product to be exactly what you ordered.

**■ INSTRUCTION MANUAL**

This manual describes necessary points of caution when you use this product, including installation, connection and basic maintenance procedures.

**POINTS OF CAUTION**

**■ POWER INPUT RATING & OPERATIONAL RANGE**

- Locate the power input rating marked on the product and confirm its operational range as indicated below:  
**AC power:** Rating  $\pm 10\%$ , 50/60  $\pm 2$  Hz, approx. 2VA  
**DC power:** Rating  $\pm 10\%$ , approx. 2W

**■ GENERAL PRECAUTIONS**

- Before you remove the unit from its base socket or mount it, turn off the power supply and input signal for safety.

**■ ENVIRONMENT**

- Indoor use.
- When heavy dust or metal particles are present in the air, install the unit inside proper housing with sufficient ventilation.
- Do not install the unit where it is subjected to continuous vibration. Do not subject the unit to physical impact.
- Environmental temperature must be within -5 to +55°C (23 to 131°F) with relative humidity within 30 to 90% RH in order to ensure adequate life span and operation.

**■ WIRING**

- Do not install cables close to noise sources (relay drive cable, high frequency line, etc.).
- Do not bind these cables together with those in which noises are present. Do not install them in the same duct.

**■ AND ....**

- The unit is designed to function as soon as power is supplied, however, a warm up for 10 minutes is required for satisfying complete performance described in the data sheet.

**COMPONENT IDENTIFICATION**

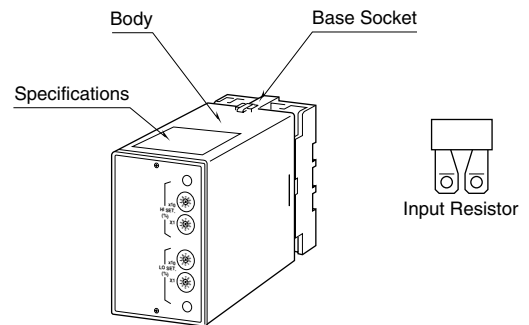

**■ FRONT PANEL CONFIGURATION**

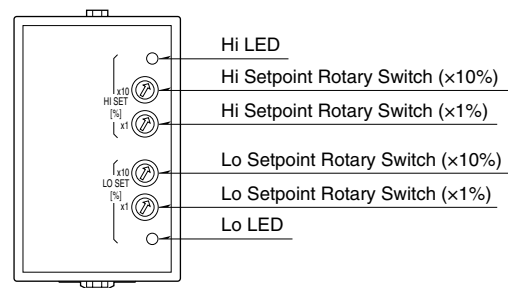

**• Explanations**

Hi and Lo setpoint rotary switches are used to set the alarm setpoints. The Hi and Lo LED, turn on when the coil for each relay is energized.

**• Examples**

For setting the relay to trip above 80% of the full-scale input signal, set the Hi rotary switch (x10) to "8", while the switch (x1) to "0".

**INSTALLATION**

Detach the yellow clamps located at the top and bottom of the unit for separate the body from the base socket.

**■ DIN RAIL MOUNTING**

Set the base socket so that its DIN rail adaptor is at the bottom. Hang the upper hook at the rear side of base socket on the DIN rail and push in the lower. When removing the socket, push down the DIN rail adaptor utilizing a minus screwdriver and pull.

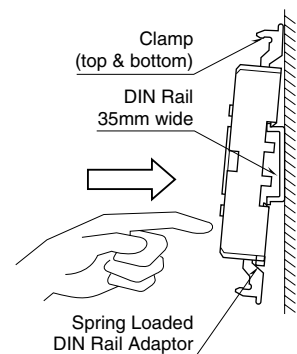

**■ WALL MOUNTING**

Refer to "EXTERNAL DIMENSIONS."

Shape and size of the base socket are slightly different with various socket types.

# TERMINAL CONNECTIONS

Connect the unit as in the diagram below or refer to the connection diagram on the front of the unit.  
 When an input resistor is provided with the module, attach it together with input wiring to the input screw terminals.

■ EXTERNAL DIMENSIONS unit: mm (inch)

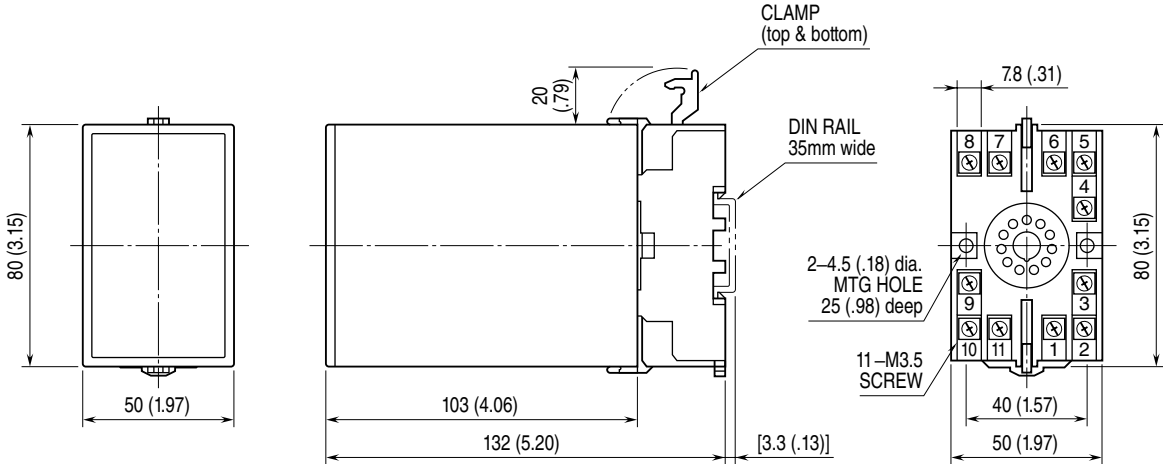

• When mounting, no extra space is needed between units.

■ CONNECTION DIAGRAM

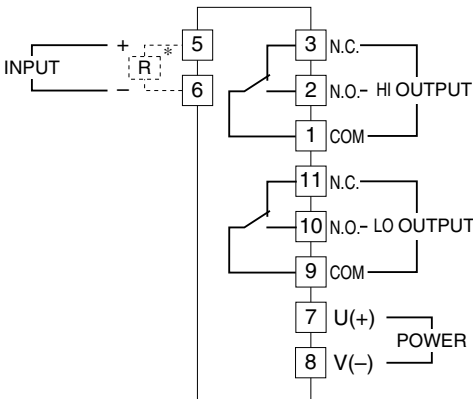

\*Input shunt resistor attached for current input.

■ TERMINAL ASSIGNMENTS unit: mm (inch)

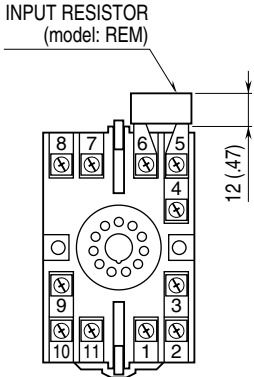

Input shunt resistor attached for current input.

## CHECKING

- 1) Terminal wiring: Check that all cables are correctly connected according to the connection diagram.
- 2) Power input voltage: Check voltage across the terminal 7 – 8 with a multimeter.
- 3) Input: Check that the input signal is within 0 – 100% of the full-scale.
- 4) Alarm operations: Check the alarm operations referring to the figure below.
- 5) Output load: Check that the output load is 380V AC/120VA or 125V DC/30W at the maximum. For maximum relay life with inductive load, external protection is recommended.

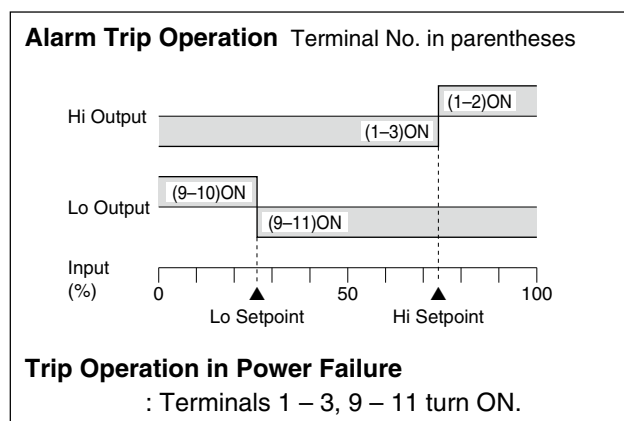

## MAINTENANCE

Regular calibration procedure is explained below:

### ■ CALIBRATION

Warm up the unit for at least 10 minutes.

#### • Hi Setpoint

Increase the input signal from a value lower than the setpoint and check that the trip point remains within the accuracy described in the data sheet.

#### • Lo Setpoint

Decrease the input signal from a value higher than the setpoint and check that the trip point remains within the accuracy described in the data sheet.

When the trip points are shifted, please contact our sales office or representatives.

## LIGHTNING SURGE PROTECTION

We offer a series of lightning surge protector for protection against induced lightning surges. Please contact us to choose appropriate models.