

PULSE ISOLATOR
(two isolated outputs; built-in excitation)

MODEL **KWYPD**

BEFORE USE

Thank you for choosing us. Before use, please check contents of the package you received as outlined below. If you have any problems or questions with the product, please contact our sales office or representatives.

■ **PACKAGE INCLUDES:**

Signal conditioner (body + base socket).....(1)

■ **MODEL NO.**

Confirm Model No. marking on the product to be exactly what you ordered.

■ **INSTRUCTION MANUAL**

This manual describes necessary points of caution when you use this product, including installation, connection and basic maintenance procedures.

POINTS OF CAUTION

■ **POWER INPUT RATING & OPERATIONAL RANGE**

- Locate the power input rating marked on the product and confirm its operational range as indicated below:
AC power: Rating $\pm 10\%$, 50/60 ± 2 Hz, approx. 2.5VA
DC power: Rating $\pm 10\%$, approx. 2W

■ **GENERAL PRECAUTIONS**

- Before you remove the unit from its base socket or mount it, turn off the power supply and input signal for safety.

■ **ENVIRONMENT**

- Indoor use.
- When heavy dust or metal particles are present in the air, install the unit inside proper housing with sufficient ventilation.
- Do not install the unit where it is subjected to continuous vibration. Do not subject the unit to physical impact.
- Environmental temperature must be within -5 to +55°C (23 to 131°F) with relative humidity within 30 to 90% RH in order to ensure adequate life span and operation.

■ **WIRING**

- Do not install cables close to noise sources (relay drive cable, high frequency line, etc.).
- Do not bind these cables together with those in which noises are present. Do not install them in the same duct.

■ **AND**

- The unit is designed to function as soon as power is supplied, however, a warm up for 10 minutes is required for satisfying complete performance described in the data sheet.

COMPONENT IDENTIFICATION

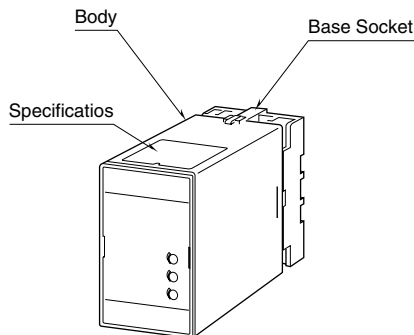

■ **FRONT PANEL CONFIGURATION**

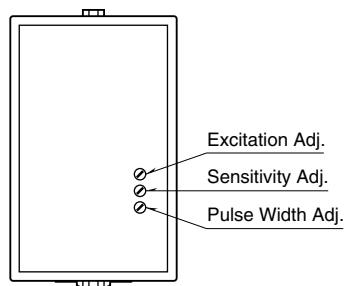

- Excitation adjustment: 5 – 12 V
- Sensitivity adjustment: threshold level for voltage pulse input; 2 – 10 V
- Pulse width adjustment: for one-shot output; 1 – 30 msec. or 30 msec. – 1 sec.

INSTALLATION

Detach the yellow clamps located at the top and bottom of the unit for separate the body from the base socket.

■ **DIN RAIL MOUNTING**

Set the base socket so that its DIN rail adaptor is at the bottom. Hang the upper hook at the rear side of base socket on the DIN rail and push in the lower. When removing the socket, push down the DIN rail adaptor utilizing a minus screwdriver and pull.

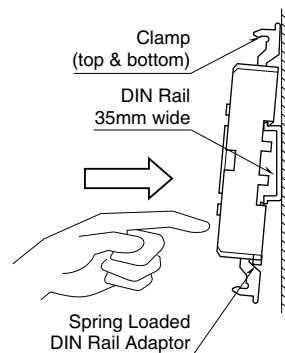

■ **WALL MOUNTING**

Refer to "EXTERNAL DIMENSIONS."

Shape and size of the base socket are slightly different with various socket types.

TERMINAL CONNECTIONS

Connect the unit as in the diagram below or refer to the connection diagram on the front of the unit.

EXTERNAL DIMENSIONS unit: mm (inch)

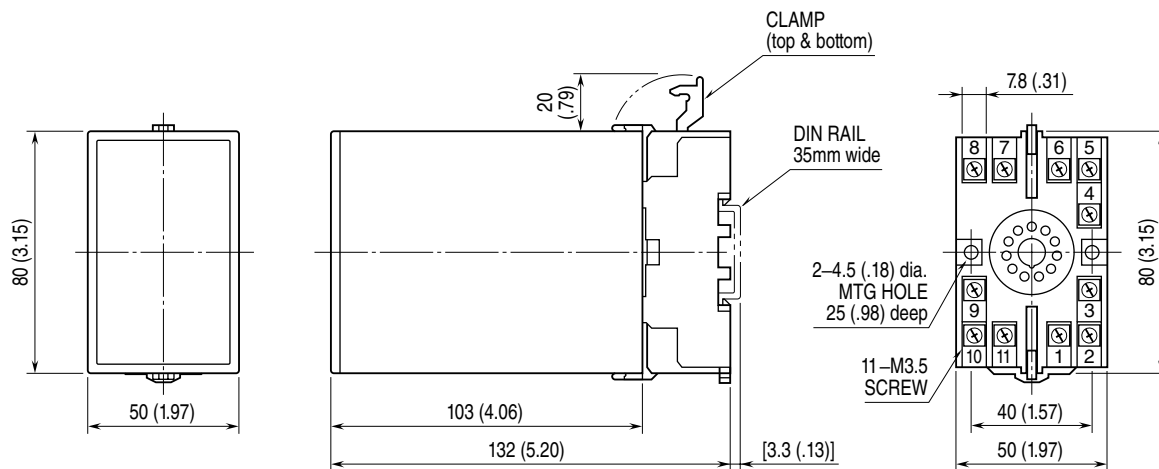

CONNECTION DIAGRAM

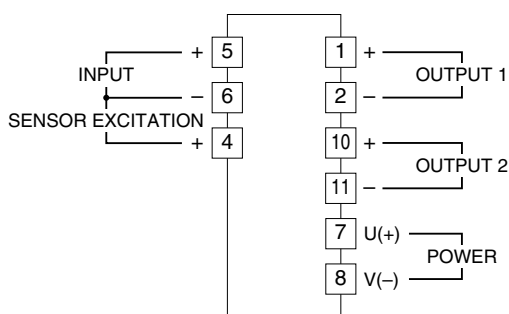

Input Connection Examples

■ Dry Contact

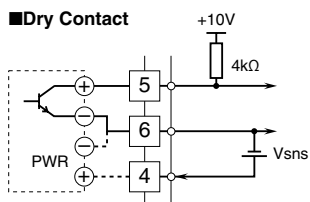

■ 2-Wire Current Pulse • Built-in Excitation

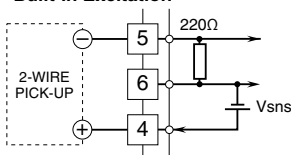

■ Voltage Pulse

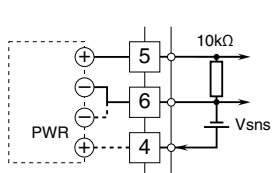

■ External DC Supply

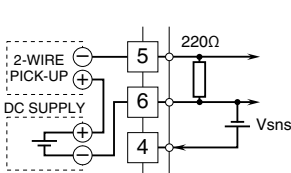

Output Connection Examples

■ Open Collector

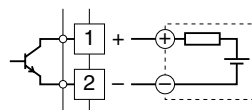

■ Voltage Pulse

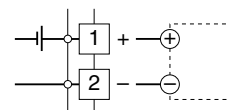

■ Relay Contact

• AC Powered

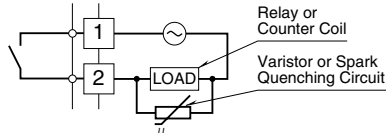



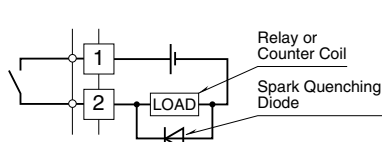

• DC Powered



OUTPUT LOGIC

■ When an Open Collector is not Mixed with the Another Output Type:

OUTPUT WAVEFORM		INPUT WAVEFORM	VOLTAGE PULSE or 2-WIRE CURRENT PULSE	DRY CONTACT
			H L	OFF ON
NON INVERTED	No pulse width conversion	Voltage pulse	H L	H L
		Open collector or relay contact	OFF ON	OFF ON
	One-shot, detecting input pulse rise 	Voltage pulse	H L	H L
		Open collector or relay contact	OFF ON	OFF ON
	One-shot, detecting input pulse sink 	Voltage pulse	H L	H L
		Open collector or relay contact	OFF ON	OFF ON
INVERTED	No pulse width conversion	Voltage pulse	H L	H L
		Open collector or relay contact	OFF ON	OFF ON
	One-shot, detecting input pulse rise 	Voltage pulse	H L	H L
		Open collector or relay contact	OFF ON	OFF ON
	One-shot, detecting input pulse sink 	Voltage pulse	H L	H L
		Open collector or relay contact	OFF ON	OFF ON

The pulse width in one-shot means the bold lined section of a pulse waveform.





 Shades indicate default setting.

Input pulse rise/sink detected with voltage level



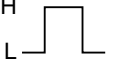

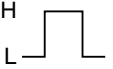
■ When an Open Collector is Mixed with Another Output Type:

When combinations “a voltage pulse and an open collector” or “a relay contact and an open collector” are chosen, be aware that the open collector’s output logic is reversed.



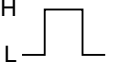

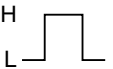
[example 1] Input : voltage pulse
Output 1: voltage pulse
Output 2: open collector

PULSE LOGIC	INPUT (voltage pulse)	OUTPUT 1 (voltage pulse)	OUTPUT 2 (open collector)
Non Inverted	H L 	H L 	OFF ON 
Inverted	H L 	H L 	OFF ON 

[example 2] Input : voltage pulse
Output 1: relay contact
Output 2: open collector

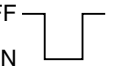
PULSE LOGIC	INPUT (voltage pulse)	OUTPUT 1 (relay contact)	OUTPUT 2 (open collector)
Non Inverted	H L 	OFF ON 	OFF ON 
Inverted	H L 	OFF ON 	OFF ON 

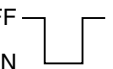
[example 3] Input : open collector
Output 1: open collector
Output 2: voltage pulse

PULSE LOGIC	INPUT (open collector)	OUTPUT 1 (open collector)	OUTPUT 2 (voltage pulse)
Non Inverted	OFF ON 	OFF ON 	H L 
Inverted	OFF ON 	OFF ON 	H L 

CHECKING

- 1) Terminal wiring: Check that all cables are correctly connected according to the connection diagram.
- 2) Power input voltage: Check voltage across the terminal 7 – 8 with a multimeter.
- 3) Check input signal.
- 4) Sensor excitation: Check that the load for the sensor excitation is within the permissible limit.
- 5) Output: Check that the load resistance meets the described specifications.

LIGHTNING SURGE PROTECTION

We offer a series of lightning surge protectors for protection against induced lightning surges. Please contact us to choose appropriate models.