

**CT TRANSDUCER  
(self-powered)**

MODEL **LCNA/LCNE**

**BEFORE USE ....**

Thank you for choosing us. Before use, please check contents of the package you received as outlined below. If you have any problems or questions with the product, please contact our sales office or representatives.

**■ PACKAGE INCLUDES:**

Signal conditioner .....(1)

**■ MODEL NO.**

Confirm Model No. marking on the product to be exactly what you ordered.

**■ INSTRUCTION MANUAL**

This manual describes necessary points of caution when you use this product, including installation, connection and basic maintenance procedures.

**POINTS OF CAUTION**

**■ GENERAL PRECAUTIONS**

- Before you remove the unit or mount it, turn off the input signal for safety.

**■ ENVIRONMENT**

- Indoor use.
- When heavy dust or metal particles are present in the air, install the unit inside proper housing with sufficient ventilation.
- Do not install the unit where it is subjected to continuous vibration. Do not subject the unit to physical impact.
- Environmental temperature must be within -10 to +55°C (14 to 131°F) with relative humidity within 30 to 85% RH in order to ensure adequate life span and operation.

**■ WIRING**

- Do not install cables close to noise sources (relay drive cable, high frequency line, etc.).
- Do not bind these cables together with those in which noises are present. Do not install them in the same duct.

**■ AND ....**

- The unit is designed to function as soon as the input signal is supplied, however, a warm up for 10 minutes is required for satisfying complete performance described in the data sheet.

**COMPONENT IDENTIFICATION**

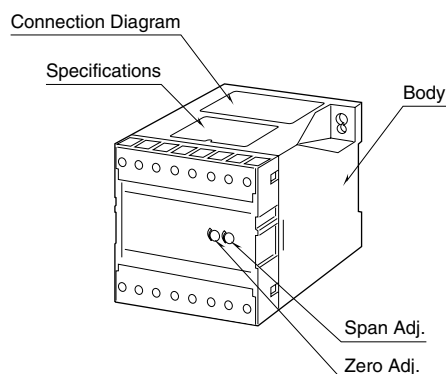

**INSTALLATION**

**■ DIN RAIL MOUNTING**

Set the unit so that its DIN rail adaptor is at the bottom. Position the upper hook at the rear side of the unit on the DIN rail and push in the lower. When removing the unit, push down the DIN rail adaptor utilizing a screwdriver (-) and pull.

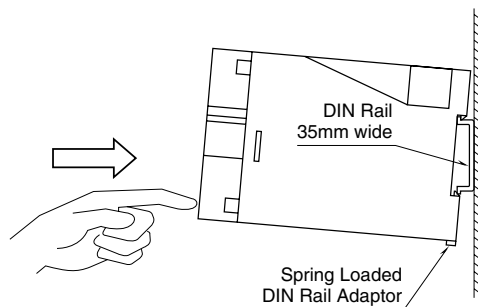

**■ WALL MOUNTING unit: mm (inch)**

**■ M5 SCREWS**

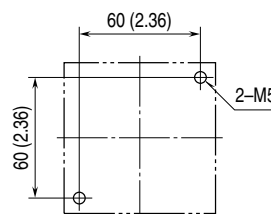

**■ M4 SCREWS**

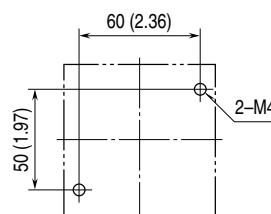

# TERMINAL CONNECTIONS

Connect the unit as in the diagram below or refer to the connection diagram on the top of the unit.

## EXTERNAL DIMENSIONS unit: mm (inch)

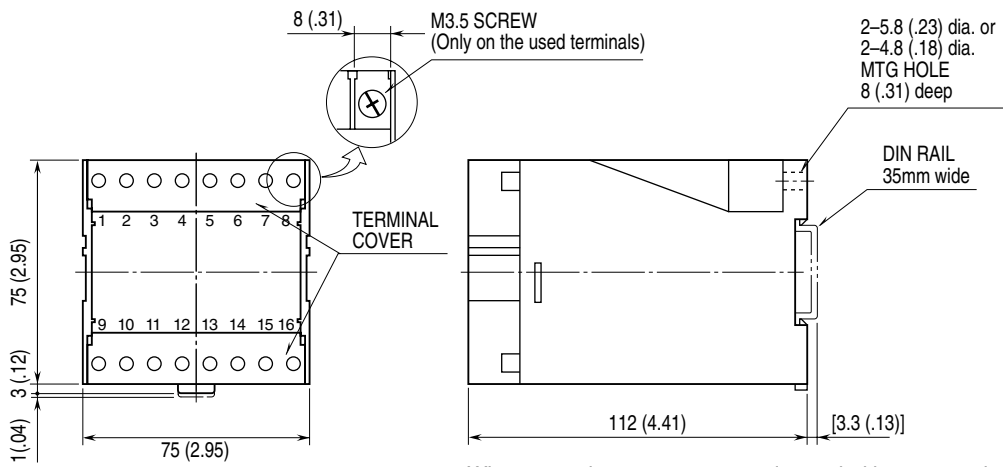

•When mounting, no extra space is needed between units.

## CONNECTION DIAGRAM

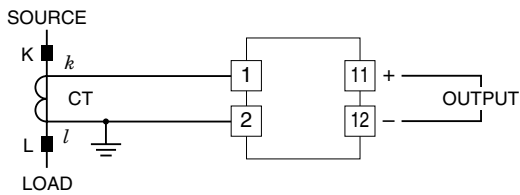

## TERMINAL ASSIGNMENTS

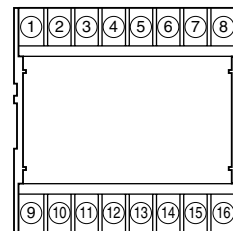

---

## WIRING INSTRUCTIONS

### ■ SCREW TERMINAL

Torque: 0.8 N·m

---

## CHECKING

- 1) Terminal wiring: Check that all cables are correctly connected according to the connection diagram.
- 2) Input: Check that the input shows within 10 – 120% of the rated current.  
Be sure to short the secondary side of CT or turn off the current at its primary side for preventing the CT from burning when the cables are to be disconnected from input terminals.  
Be sure that the input waveform is sinusoidal to obtain proper accuracy for model LCNA.
- 3) Output: Check that the load resistance meets the described specifications.

---

## ADJUSTMENT PROCEDURE

This unit is calibrated at the factory to meet the ordered specifications, therefore you usually do not need any calibration.

For matching the signal to a receiving instrument or in case of regular calibration, adjust the output as explained in the following.

### ■ HOW TO CALIBRATE THE OUTPUT SIGNAL

Use a signal source and measuring instruments of sufficient accuracy level. Turn the input signal on and warm up for more than 10 minutes.

- SPAN: Apply 100% input and adjust output to 100%.  
SPAN is adjustable to  $\pm 5\%$ .

---

## MAINTENANCE

Regular calibration procedure is explained below:

### ■ CALIBRATION

Warm up the unit for at least 10 minutes. Apply 10%, 25%, 50%, 75% and 100% input signal. Check that the output signal for the respective input signal remains within accuracy described in the data sheet. When the output is out of tolerance, recalibrate the unit according to the “ADJUSTMENT PROCEDURE” explained earlier.

---

## LIGHTNING SURGE PROTECTION

We offer a series of lightning surge protector for protection against induced lightning surges. Please contact us to choose appropriate models.