

BEFORE USE

Thank you for choosing us. Before use, please check contents of the package you received as outlined below. If you have any problems or questions with the product, please contact our sales office or representatives.

■ PACKAGE INCLUDES:

Valve positioner (body + base socket).....(1)

■ MODEL NO.

Confirm Model No. marking on the product to be exactly what you ordered.

■ INSTRUCTION MANUAL

This manual describes necessary points of caution when you use this product, including installation, connection and basic maintenance procedures.

POINTS OF CAUTION

Press vertically the center of the service pin or the reset switch within the maximum strength of 9.8 N. Pressing them in slanted angles or at the edge may lead to unexpected failures.

■ POWER INPUT RATING & OPERATIONAL RANGE

- Locate the power input rating marked on the product and confirm its operational range as indicated below:
AC power: Rating $\pm 10\%$, 50/60 ± 2 Hz, approx. 3VA

■ GENERAL PRECAUTIONS

- Before you remove the unit from its base socket or mount it, turn off the power supply and power to a motor for safety.

■ ENVIRONMENT

- Indoor use.
- When heavy dust or metal particles are present in the air, install the unit inside proper housing with sufficient ventilation.
- Do not install the unit where it is subjected to continuous vibration. Do not subject the unit to physical impact.
- Environmental temperature must be within -5 to +60°C (23 to 140°F) with relative humidity within 30 to 90% RH in order to ensure adequate life span and operation.

■ WIRING

- Do not install cables close to noise sources (relay drive cable, high frequency line, etc.).
- Do not bind these cables together with those in which noises are present. Do not install them in the same duct.

■ AND

- The unit is designed to function as soon as power is supplied, however, a warm up for 10 minutes is required for satisfying complete performance described in the data sheet.
- For detailed specifications of the network, refer to Echelon's LONWORKS FTT-10A Free Topology Transceiver User's Guide.

COMPONENT IDENTIFICATION

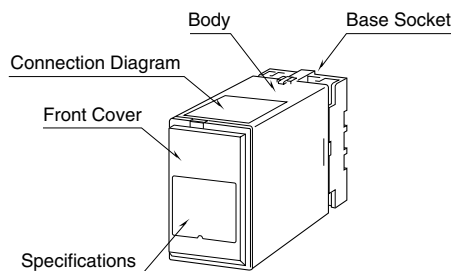

■ HOW TO OPEN THE FRONT COVER:

Hang your finger on the hook at the top of the front cover and pull.

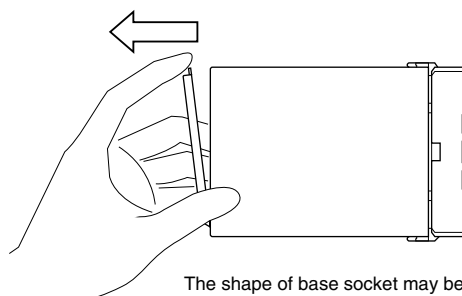

The shape of base socket may be different for some models.

■ FRONT PANEL CONFIGURATIONS

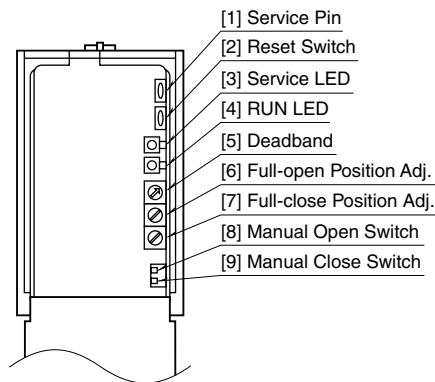

- 1) SERVICE pin: Used to configurate nodes in installation. Transmits network management messages including 48-bit Neuron ID.
- 2) RESET switch: Resets the Neuron Chip.
- 3) SERVICE LED: Turns on when there is no valid application codes or when a failure is detected. Blinks in 0.5 Hz when network address information is not yet configured.
- 4) RUN LED: Blinks in 0.5 Hz in normal operations. Blinks in 2 Hz when the lock protection timer is actuated. Blinks in approx. 5 Hz for 3 seconds when Wink message is received.

INSTALLATION

Detach the yellow clamps located at the top and bottom of the unit for separate the body from the base socket.

■ DIN RAIL MOUNTING

Set the base socket so that its DIN rail adaptor is at the bottom. Hang the upper hook at the rear side of base socket on the DIN rail and push in the lower. When removing the socket, push down the DIN rail adaptor utilizing a minus screwdriver and pull.

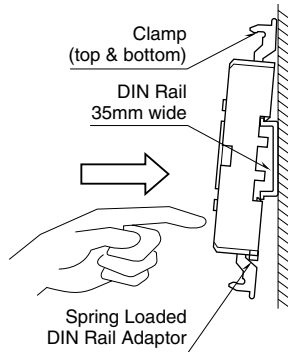

■ WALL MOUNTING

Refer to "EXTERNAL DIMENSIONS."

Shape and size of the base socket are slightly different with various socket types.

TERMINAL CONNECTIONS

Connect the unit as in the diagram below or refer to the connection diagram on the top of the unit.

■ EXTERNAL DIMENSIONS unit: mm (inch)

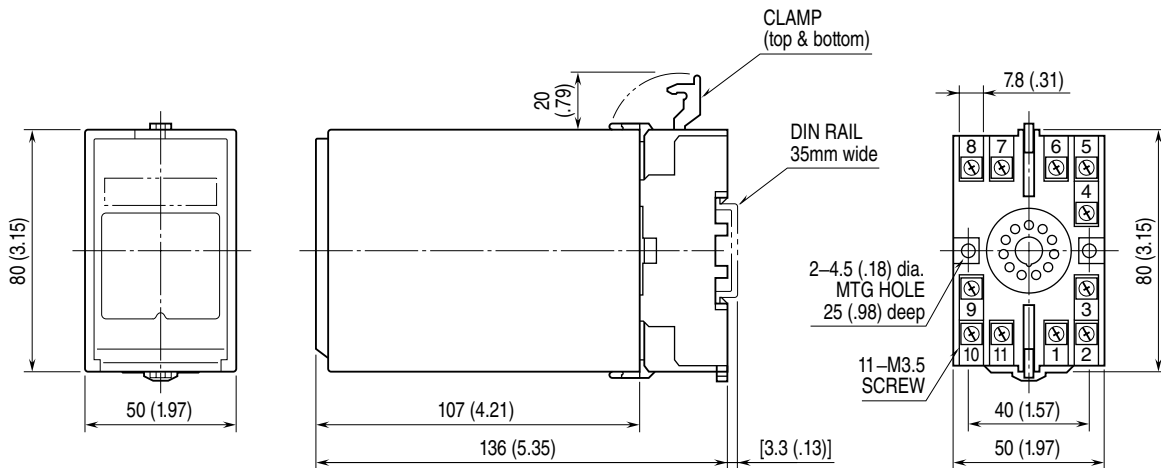

• When mounting, no extra space is needed between units.

■ CONNECTION DIAGRAM

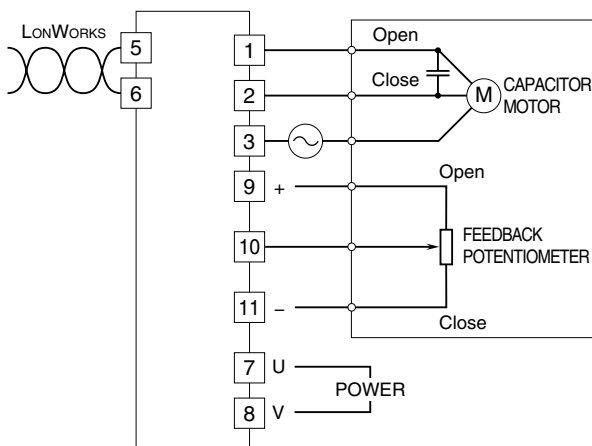

Note: Note that when limit switches inserted in motor wiring, the making/breaking may cause stress on the SSRs.

NETWORK VARIABLE

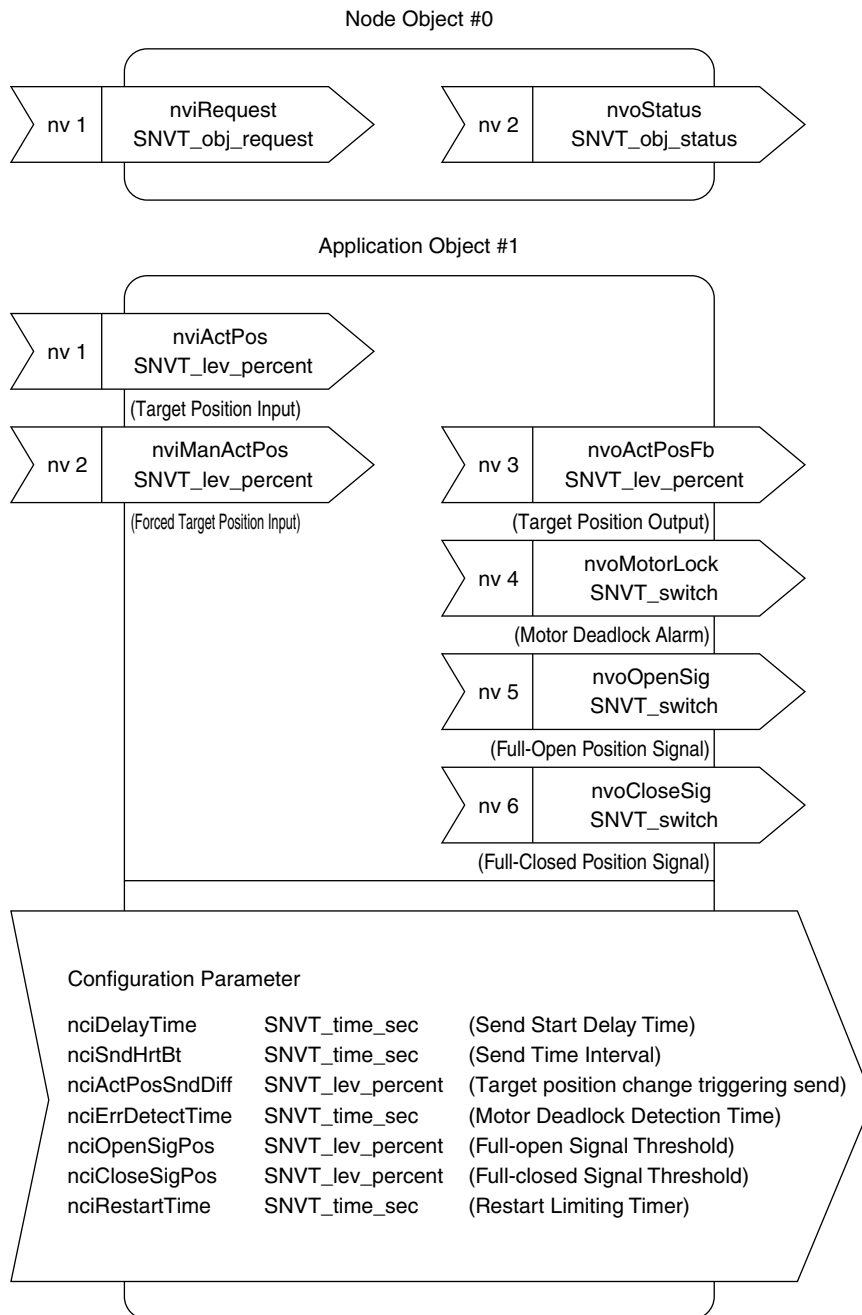

NETWORK VARIABLE	TYPE {Range} {Default}	DEFINITION	EXPLANATIONS
nviRequest	SNVT_obj_request {RQ_NORMAL RQ_REPORT_MASK RQ_UPDATE_STATUS}	<ul style="list-style-type: none"> •RQ_NORMAL Functions the same as RQ_UPDATE_STATUS. •RQ_REPORT_MASK Supported status bits are sent from nvoStatus. 1 is set at status bits when they are supported. Otherwise, 0 is set. invalid_id, invalid_request and manual_control are to be supported. •RQ_UPDATE_STATUS Status bits of a selected Object are sent from nvoStatus. Status bits of Node Object and Application Object are identical, excluding object_id. invalid_id, invalid_request and manual_control are to be supported. When manual open/close SW is on, 1 is set at manual_control, and both nviActPos and nviManActPos are invalid. 	
nviActPos	SNVT_lev_percent {0..100%} {163.835%} = INVALID	Position setpoint input 0 to 100%; 0.1% increments 163.835% is set as INVALID data at startup. As nviManActPos has priority, nviActPos becomes invalid when valid data is set at nviManActPos.	Data less than 0% are processed as 0%. Data greater than 100% are processed as 100%. Exception: INVALID data (163.835%) stops control. To make data at nviActPos valid, set INVALID data at nviManActPos.
nviManActPos	SNVT_lev_percent {0..100%} {163.835%} = INVALID	Forced position setpoint input 0 to 100%; 0.1% increments 163.835% is set as INVALID data at startup. As nviManActPos has priority, nviActPos becomes invalid when valid data is set at nviManActPos.	Data less than 0% are processed as 0%. Data greater than 100% are processed as 100%. Exception: INVALID data (163.835%) stops control. To make data at nviActPos valid, set INVALID data at nviManActPos.
nvoActPosFb	SNVT_lev_percent {-18.2..118.2%} {163.835%} = INVALID	Position output -18.2 to 118.2%; 0.1% increments 163.835% is set as INVALID data at startup.	Outputs actual position value from sensor 0% = close 100% = open
nvoMotorLock	SNVT_switch {value = 0 / state = 0..1} {value = 0 / state = 0}	Motor deadlock alarm value is fixed to 0. Use only state. At startup state = 0 0: normal 1: deadlock alarm	1 is set at state when deviation wouldn't come into deadband even after motor-driving time exceeds the preset time at nciErrDetectTime. To cancel the alarm, take either of following three steps. 1) Turn power input off and then on. 2) Issue RESET command with tool. 3) Apply position setpoint input value such that motor reversely rotates.
nvoOpenSig	SNVT_switch {value = 0 / state = 0..1} {value = 0 / state = 0}	Full-open position signal value is fixed to 0. Use only state. At startup state = 0 0: invalid 1: valid Sends only when state changes.	1 is set at state when nvoActPosFb is greater than or equal to nciOpenSigPos. Otherwise, 0 is set.
nvoCloseSig	SNVT_switch {value = 0 / state = 0..1} {value = 0 / state = 0}	Full-close position signal Value is fixed to 0. Use only state. At startup state = 0 0: invalid 1: valid Sends only when state changes.	1 is set at state when nvoActPosFb is less than or equal to nciCloseSigPos. Otherwise, 0 is set.

NETWORK VARIABLE	TYPE {Range} {Default}	DEFINITION	EXPLANATIONS
nciDelayTime	SNVT_time_sec {0..6553.4 sec.} {0 sec.}	Delay time to start sending 0 to 6553.4 sec.; 0.1 sec. increments Factory setting: 0 sec.	Period of time from immediately after startup during which no network variables are output
nciSndHrtBt	SNVT_time_sec {1..6553.4 sec.} {10} 0 = OFF	Sending time intervals of nvoActPosFb 1 to 6553.4 sec.; 0.1 sec. increments Factory setting: 10 sec. 0 equals to OFF and the parameter becomes invalid. 0 setting is required in case of using nciActPosSndDiff as trigger.	Intervals of time stamp sending of nvoActPosFb nvoActPosFb is not sent when both nciSndHrtBt and nciActPosSndDiff are 0. Logical AND is applied and sent when both nciSndHrtBt and nciActPosSndDiff are valid.
nciActPosSndDiff	SNVT_lev_percent {0.1..100 %} {0} = OFF	Amount of position change to be trigger for sending nvoActPosFb. 0.1 to 100%; 0.1% increments Factory set to 0, which equals to OFF, and the parameter is invalid. 0 setting is required in case of using nciSndHrtBt as trigger.	nvoActPosFb is sent each time position value changes by the set value. nvoActPosFb is not sent when both nciSndHrtBt and nciActPosSndDiff are 0. Logical AND is applied and sent when both nciSndHrtBt and nciActPosSndDiff are valid.
nciErrDetectTime	SNVT_time_sec {0..6.5553.4 sec.} {0} = OFF	Motor deadlock detecting time 0 to 6553.4 sec.; 0.1 sec. increments Factory set to 0, which equals to OFF, and the parameter is invalid.	Outputs 1 for nvoMotorLock to stop motor driving when deviation wouldn't come into deadband even after the motor-driving time exceeds the set period of time. Refer to nvoMotorLock.
nciOpenSigPos	SNVT_lev_percent {0..100 %} {98 %}	Threshold to output nvoOpenSig 0 to 100%; 0.1% increments Factory setting: 98%	Refer to nvoOpenSig.
nciCloseSigPos	SNVT_lev_percent {0..100 %} {2 %}	Threshold to output nvoCloseSig 0 to 100%; 0.1% increments Factory setting: 2%	Refer to nvoCloseSig.
nciRestartTime	SNVT_time_sec {0..6.5553.4 sec.} {1 sec.}	Restart limiting timer 0 to 6553.4 sec.; 0.1 sec. increments Factory setting: 1	Period of time after motor deadlock or reverse rotation during which the motor cannot restart to prevent itself from heating up.

CHECKING

- 1) Terminal wiring: Check that all cables are correctly connected according to the connection diagram.
- 2) Power input voltage: Check voltage across the terminal 7 – 8 with a multimeter.
- 3) Feedback potentiometer: Check that voltage across terminals 9 – 11 shows 3.3V and 10 – 11 shows within 0 to 3.3V.
- 4) Output: Check voltage across the output terminals.

MANUAL OPERATION

Even when there is no input signal from LONWORKS, it is possible to force the position to be 0% or 100% using manual operation switches inside the front cover. Manual operation switch has priority over the opening position from LONWORKS, therefore, when the control is intended to be from LONWORKS, be sure to turn off the manual operation switch. Also turning both (open and close) switches on, both will become invalid. The status of manual switch can be read from manual_control at nvoStatus (Refer to “NETWORK VARIABLE” section). Manual operation is not available when service LED is blinking due to an unconfigured network address.

TERMINATING RESISTOR

The network needs to be connected to terminating resistor(s).

A terminating resistor comprises of a resistor and two capacitors (Refer to the drawing below).

■ BUS TOPOLOGY

Two terminating resistors provided at both ends of the bus are necessary.

$$R = 105 \Omega \pm 1\% \quad 1/8 \text{ W}$$

■ FREE TOPOLOGY

Connect a terminating resistor to an optional part on the network.

$$R = 52.3 \Omega \pm 1\% \quad 1/8 \text{ W}$$

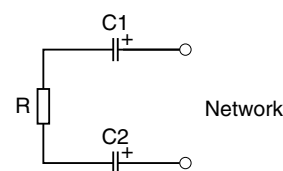

C1, C2: 100 μ F \geq 50 V

ADJUSTMENTS

■ FULL-CLOSE POSITION

Turn manual close switch on or apply 0% setpoint signal and adjust the 0% position with full-close position adj. Adjustable within 0 to 25%. (factory setting: 0%)

■ FULL-OPEN POSITION

Turn manual open switch on or apply 100% setpoint signal and adjust the 100% position with full-open position adj. Adjustable within 75 to 100%. (factory setting: 100%)

Check once more full-close position and confirm there is no deviation, if so, adjust repeatedly.

After adjustment, be sure to turn off manual switches.

■ DEADBAND

Protect from hunting by increasing the deadband switch value.

A model without a brake stops immediately after a deviation goes into the deadband range and the control will be recovered when the deviation is out of the deadband range.

A model with a brake stops immediately after a deviation goes to 0 regardless of the set value of deadband range by applying the brake. The control will be recovered when the deviation is out of the deadband range.

(factory setting: 1.5%)

Deadband adjustment

Deadband adj. SW	Deadband (%)
0	0.1
1	0.3
2	0.5
3	0.7
4	1.0
5	1.5
6	2.0
7	3.0
8	5.0
9	8.0

LIGHTNING SURGE PROTECTION

We offer a series of lightning surge protector for protection against induced lightning surges. Please contact us to choose appropriate models.