

RATIO/BIAS TRANSMITTER
(output bias; thumbwheel switch adjustments)

MODEL **MRTD**

BEFORE USE

Thank you for choosing us. Before use, please check contents of the package you received as outlined below. If you have any problems or questions with the product, please contact our sales office or representatives.

PACKAGE INCLUDES:

Signal conditioner
(body + base socket + input resistor).....(1)
Input resistor is provided only with current input type.

MODEL NO.

Confirm Model No. marking on the product to be exactly what you ordered.

INSTRUCTION MANUAL

This manual describes necessary points of caution when you use this product, including installation, connection and basic maintenance procedures.

POINTS OF CAUTION

POWER INPUT RATING & OPERATIONAL RANGE

- Locate the power input rating marked on the product and confirm its operational range as indicated below:
AC power: Rating $\pm 10\%$, 50/60 ± 2 Hz, approx. 2VA
DC power: Rating $\pm 10\%$, approx. 2W
 or 85 – 150V, approx. 2W for 110V rating

GENERAL PRECAUTIONS

- Before you remove the unit from its base socket or mount it, turn off the power supply and input signal for safety.

ENVIRONMENT

- Indoor use.
- When heavy dust or metal particles are present in the air, install the unit inside proper housing with sufficient ventilation.
- Do not install the unit where it is subjected to continuous vibration. Do not subject the unit to physical impact.
- Environmental temperature must be within -5 to +60°C (23 to 140°F) with relative humidity within 30 to 90% RH in order to ensure adequate life span and operation.

WIRING

- Do not install cables close to noise sources (relay drive cable, high frequency line, etc.).
- Do not bind these cables together with those in which noises are present. Do not install them in the same duct.

AND

- The unit is designed to function as soon as power is supplied, however, a warm up for 10 minutes is required for satisfying complete performance described in the data sheet.

COMPONENT IDENTIFICATION

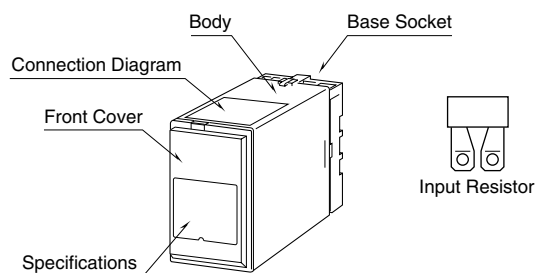

HOW TO OPEN THE FRONT COVER:

Hang your finger on the hook at the top of the front cover and pull.

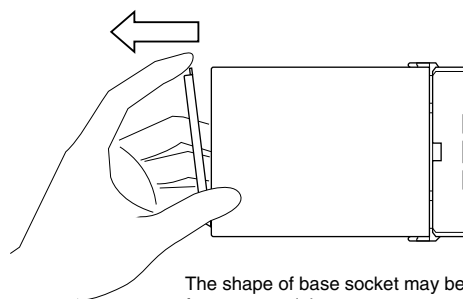

The shape of base socket may be different for some models.

INSTALLATION

Detach the yellow clamps located at the top and bottom of the unit for separate the body from the base socket.

DIN RAIL MOUNTING

Set the base socket so that its DIN rail adaptor is at the bottom. Hang the upper hook at the rear side of base socket on the DIN rail and push in the lower. When removing the socket, push down the DIN rail adaptor utilizing a minus screwdriver and pull.

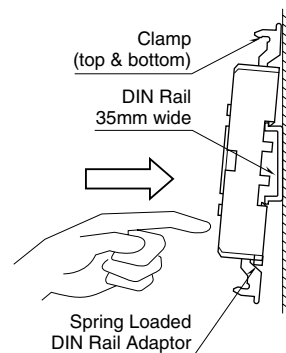

WALL MOUNTING

Refer to "EXTERNAL DIMENSIONS."

Shape and size of the base socket are slightly different with various socket types.

TERMINAL CONNECTIONS

Connect the unit as in the diagram below or refer to the connection diagram on the top of the unit.
 When an input resistor is provided with the module, attach it together with input wiring to the input screw terminals.

EXTERNAL DIMENSIONS unit: mm (inch)

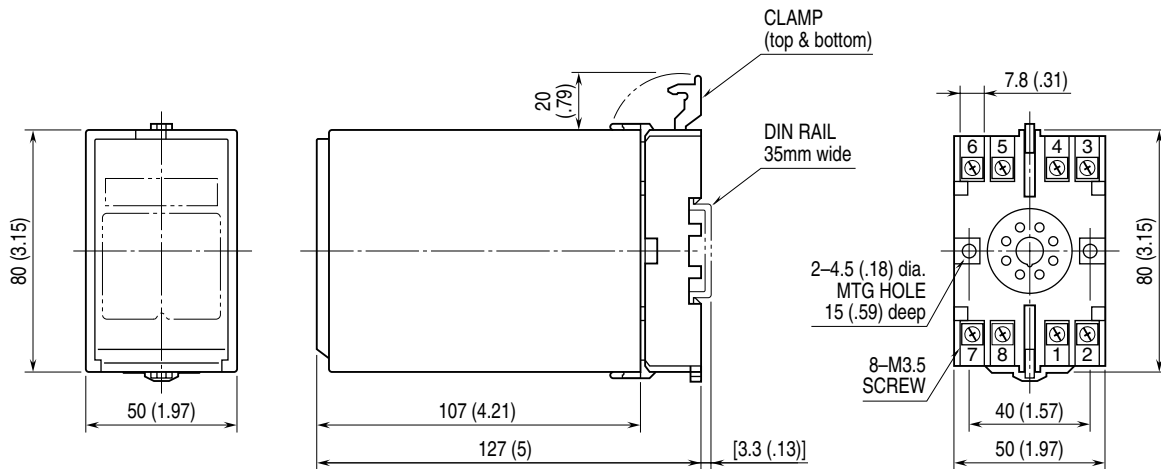

• When mounting, no extra space is needed between units.

CONNECTION DIAGRAM

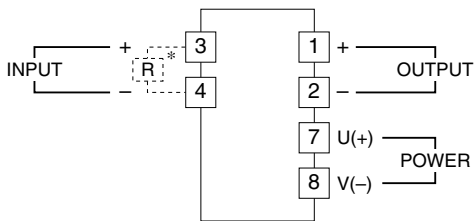

*Input shunt resistor attached for current input.

TERMINAL ASSIGNMENTS unit: mm (inch)

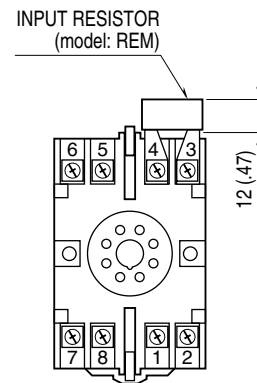

Input shunt resistor attached for current input.

CHECKING

- 1) Terminal wiring: Check that all cables are correctly connected according to the connection diagram.
- 2) Power input voltage: Check voltage across the terminal 7 – 8 with a multimeter.
- 3) Input: Check that the input signal is within 0 – 100% of the full-scale.
- 4) Output: Check that the load resistance meets the described specifications.

ADJUSTMENT PROCEDURE

This unit is calibrated at the factory to meet the ordered specifications and within the described accuracy. Adjustment procedure is as follows:

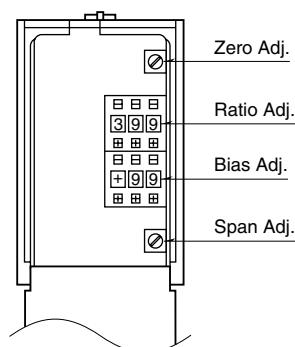

• Ratio/Bias Setting

Set respective thumbwheel switch to desired figures.

• Fine Adjustments

Accuracy level of adjustment achieved with the front thumbwheel switches are as high as $\pm 0.2\%$ for ratio and $\pm 1\%$ for bias. Finer adjustments can be done with zero and span adjustments.

- 1) With the equations $X_o = KX_i + B$ for positive ratio, and $X_o = F - KX_i + B$ for negative ratio, apply 0% input (X_i) and adjust the output (X_o) to the assumed result of equation.
- 2) Apply 100% input (X_i) and adjust the output (X_o) to the assumed result of equation.
- 3) Check the zero value (X_o) again with 0% input.
- 4) When the zero value (X_o) is changed, repeat the above procedure 1) – 3).

Factory fine adjustments are performed with parameters set to: ratio (K) = 1, bias (B) = 0.

EQUATION

$$X_o = KX_i + B \text{ for positive ratio;}$$

$$X_o = F - KX_i + B \text{ for negative ratio}$$

where X_o : output (%)

X_i : input (%)

K : ratio (0.1 – 3.99 conformance range)

B : bias (-99 – +99%)

F : 100%

[Examples of Positive Gain]

- ① $K = 1$ $B = 50\%$
- ② $K = 0.5$ $B = 50\%$
- ③ $K = 2$ $B = 0$
- ④ $K = 1$ $B = 0$
- ⑤ $K = 0.5$ $B = 0$
- ⑥ $K = 1$ $B = -50\%$

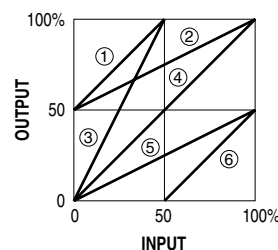

[Examples of Negative Gain]

- ① $K = 1$ $B = 50\%$
- ② $K = 0.5$ $B = -50\%$
- ③ $K = 2$ $B = 0$
- ④ $K = 1$ $B = 0$
- ⑤ $K = 0.5$ $B = 0$
- ⑥ $K = 1$ $B = -50\%$

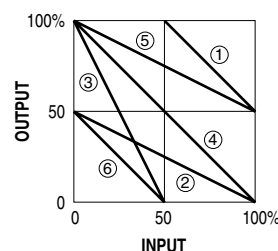

MAINTENANCE

Regular calibration procedure is explained below:

■ CALIBRATION

Warm up the unit for at least 10 minutes. Apply the input signals which should lead the calculated results as 0%, 25%, 50%, 75% and 100%. Check that the output signal for the respective input signal remains within accuracy described in the data sheet. When the output is out of tolerance, recalibrate the unit according to the “ADJUSTMENT PROCEDURE” explained earlier.

LIGHTNING SURGE PROTECTION

We offer a series of lightning surge protector for protection against induced lightning surges. Please contact us to choose appropriate models.