

FRONT VIEW & PROGRAMMING

PROGRAMMING PROCEDURE

- 1) Press ITEM UP or DOWN key until ITEM display indicates "01".
- 2) Press DATA UP or DOWN key and choose "2" on DATA display.
 - 1: Data indication only.
 - 2: All parameters are modifiable.
- 3) Press ITEM UP or DOWN key until ITEM display shows the ITEM No. you need to change.
- 4) Press DATA UP or DOWN key and choose a DATA No. or value you need on DATA display.
- 5) Repeat above 3 and 4. (Entered data is stored 1 sec. after the operation has been complete.)
- 6) Press ITEM UP or DOWN key until ITEM display indicates "01".
- 7) Press DATA UP or DOWN key and choose "1" on the display.
- 8) Press ITEM UP or DOWN key until ITEM display indicates "P".
DATA display shows process input. You can now check data setting by choosing ITEM No.

Note: DO NOT press UP and DOWN keys simultaneously.

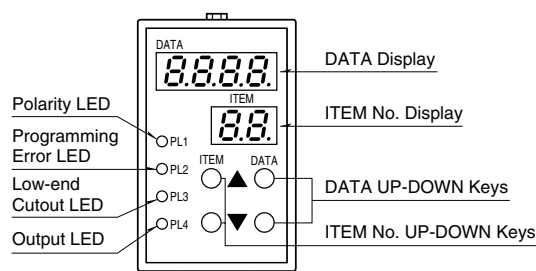

ITEM	MDF. CODE	DATA	CONTENTS	DEFAULT
P	N/A	-9999 – 9999	Input display in engineering unit (as set in ITEM 17/18)	---
01		1, 2, 3	Modification code 1: Data indication only. 2: All parameters are modifiable. 3: Only ITEM 39 is modifiable.	1
02	N/A	0, 1, 10, 20	Status indication ("0" is normally indicated.) 0 : Normal 1 : Memory error 10 : Out of display range -9999 - 9999 20 : Out of input range -15 – 115%	0
03	N/A	0, 1, 2, 3	Input type 0: S1 (-1 – +1V) 1: S2 (-10 – +10V) 2: S3 (-30 – +30V) 3: Z1 (0 – 50mA)	S1: 0 S2: 1 S3: 2 Z1: 3
04	N/A	0, 1, 2, 3	Output type 0: A (Open collector) 1: F (Voltage pulse (5 – 24V)) 2: J (RS-422 line driver pulse) 3: R (AC/DC switch)	A: 0 F: 1 J: 2 R: 3
05	2	0 – 13	Output frequency range 0: 0 – 10 kHz (selectable range 0.00 – 20.00 kHz) Minimum increments 0.01 kHz 1: 0 – 1 kHz (selectable range 0.000 – 2.000 kHz) Minimum increments 0.001 kHz 2: 0 – 100 Hz (selectable range 0.0 – 200.0 Hz) Minimum increments 0.1 Hz 3: 0 – 10 Hz (selectable range 0.00 – 20.00 Hz) Minimum increments 0.01 Hz 4: 0 – 1 Hz (selectable range 0.000 – 2.000 Hz) Minimum increments 0.001 Hz 5: 0 – 100 mHz (selectable range 0.0 – 200.0 mHz) Minimum increments 0.1 mHz 6: 0 – 10 mHz (selectable range 0.00 – 20.00 mHz) Minimum increments 0.01 mHz 7: 0 – 1 mHz (selectable range 0.000 – 2.000 mHz) Minimum increments 0.001 mHz 8: 0 – 1000 pulses/min (selectable range 0 – 2000 pulses/min) Minimum increments 1 pulse/min 9: 0 – 100 pulses/min (selectable range 0.0 – 200.0 pulses/min) Minimum increments 0.1 pulses/min 10: 0 – 10 pulses/min (selectable range 0.00 – 20.00 pulses/min) Minimum increments 0.01 pulses/min 11: 0 – 1000 pulses/h (selectable range 0 – 2000 pulses/h) Minimum increments 1 pulse/h 12: 0 – 100 pulses/h (selectable range 0.0 – 200.0 pulses/h) Minimum increments 0.1 pulses/h 13: 0 – 10 pulses/h (selectable range 0.00 – 20.00 pulses/h) Minimum increments 0.01 pulses/h (0, 1, 2 not selectable with AC/DC switch output)	1 (3 for AC/DC switch output)

ITEM	MDF CODE	DATA	CONTENTS	DEFAULT
06	2	0 – 2000	0% output frequency *1,2	0.000 (0.00*3)
07	2	0 – 2000	100% output frequency *2	1.000 (10.00*3)
08	2	0, 1, 2	Output pulse width range *4 0: Duty ratio approx. 50% 1: One-shot; 1 – 1000 msec. (50 – 1000 msec. for AC/DC switch) 2: One-shot; 1 – 10 sec.	0
09	2	1 – 1000, –	Output pulse width *5 If the preset value is wider than the cycle at 115% output, the MXAP does not function properly (Data blinks.). ' – ' indicated when ITEM 08 is set to 0, meaning this setting is unavailable.	–
10	2	5 – 24, –	Output pulse voltage (V) Selectable only with voltage pulse output. ' – ' indicated for other output types, meaning this setting is unavailable.	Code A: – Code F: 5 Code J: – Code R: –
11	2	-10 – +10, –	Output pulse voltage, fine adjustment (scale) Approx. 0.2V increments (at output pulse voltage ≤ 24V) Selectable only with voltage pulse output. ' – ' indicated for other output types, meaning this setting is unavailable.	Code A: – Code F: 0 Code J: – Code R: –
12	2	0, 1	Output pulse logic 0: Non-inverted 1: Inverted	0
13	N/A	-15.0 – 115.0	Input indicated in % (of the range set in ITEM 23/24)	---
14	2	0 – 2300	Output display in engineering unit with ITEM 01 DATA 1 (unit and decimal point position as set in ITEM 05) Loop test output with ITEM 01 DATA 2 ('L' is indicated as ITEM No.)	---
15	2	-19.99 – 19.99	Input zero adjustment (%) (fine adj. of the value set in ITEM 23)	0.00
16	2	-19.99 – 19.99	Input span adjustment (%) (fine adj. of the value set in ITEM 24)	0.00
17	2	-9999 – 9999	Display range scaling 0% *6	0.0
18	2	-9999 – 9999	Display range scaling 100% *6	100.0
19	2	0, 1, 2, 3	Decimal point position 0: _ _ _ _ for ITEM P, 17, 18 1: _ . _ . _ 2: _ . _ . _ 3: _ . . _ _	1
20	2	0, 1, 2, 3, 4	Moving average (sampling cycle: 10 msec.) 0: No 1: 4 samples 2: 8 samples 3: 16 samples 4: 32 samples	1
21	2	0, 1 – 60	Power-saving mode 0: Continuous display 1 – 60: Time before display turned off (minutes)	10
22	2	0.3 – 100.0	Low-end cutout (%) (of the input % displayed in ITEM 13; deadband 0.1%) Not valid in the loop test output mode, or when 0% output setting is not 0 Hz.	0.3
23	2	-1.00 – 1.00	Input code S1 0% input voltage (V) *7	-1.00
24	2	-1.00 – 1.00	100% input voltage (V) *7	1.00
23	2	-10.0 – 10.0	Input code S2 0% input voltage (V) *7	-10.0
24	2	-10.0 – 10.0	100% input voltage (V) *7	10.0
23	2	-30.0 – 30.0	Input code S3 0% input voltage (V) *7	-30.0
24	2	-30.0 – 30.0	100% input voltage (V) *7	30.0
23	2	0.0 – 50.0	Input code Z1 0% input current (mA) *7	4.0
24	2	0.0 – 50.0	100% input current (mA) *7	20.0
25	2	0, 1 – 9999	Automatic reset time for the totalized pulse count 0: No automatic reset 1 – 9999: Minutes before the automatic reset *8	0
26	2	0, 1	Totalized pulse count at ITEM 37/38 held at power off 0: Not hold 1: Hold	0
27	N/A	0 – 9999	Past totalized pulse count reset, five times before the last, upper 4 digits *9	---
28	N/A	0 – 9999	Past totalized pulse count reset, five times before the last, lower 4 digits *9	---
29	N/A	0 – 9999	Past totalized pulse count reset, four times before the last, upper 4 digits *9	---
30	N/A	0 – 9999	Past totalized pulse count reset, four times before the last, lower 4 digits *9	---
31	N/A	0 – 9999	Past totalized pulse count reset, three times before the last, upper 4 digits *9	---
32	N/A	0 – 9999	Past totalized pulse count reset, three times before the last, lower 4 digits *9	---
33	N/A	0 – 9999	Past totalized pulse count reset, twice before the last, upper 4 digits *9	---
34	N/A	0 – 9999	Past totalized pulse count reset, twice before the last, lower 4 digits *9	---
35	N/A	0 – 9999	Past totalized pulse count reset, last time, upper 4 digits *9	---
36	N/A	0 – 9999	Past totalized pulse count reset, last time, lower 4 digits *9	---
37	N/A	0 – 9999	Totalized pulse count, upper 4 digits *10	0
38	N/A	0 – 9999	Totalized pulse count, lower 4 digits *10	0
39	3	0, 1	Reset all settings *11	0
40	N/A	---	ROM version	---

- *1. With 0 Hz setting, the input between -15% and 0% is automatically cut to 0 Hz (no output).
- *2. Unit and decimal point position as set in ITEM 05. ITEM 06 < ITEM 07.
- *3. For AC/DC switch output.
- *4. With 1 or 2 setting, the output pulse width is constant regardless of frequency.
- *5. Maintain the minimum OFF pulse width of 25 msec. (ON pulse width when inverted) for AC/DC switch output.
- *6. Of the range selected in ITEM 23/24. ITEM 17 < ITEM 18.
- *7. ITEM 23 < ITEM 24.
- *8. Clock accuracy ± 5 sec. (approx.) per day (1440 minutes)
- *9. No display indication when the automatic reset is not specified.
Pressing DATA UP-DOWN keys simultaneously for longer than 4 seconds resets the pulse count values in ITEMS 27 to 36.
- *10. Pressing DATA UP-DOWN keys simultaneously for longer than 4 seconds resets the pulse count values.
(Also valid in the automatic reset mode.)
- *11. Press DATA UP key and choose DATA 1. Double-click DATA DOWN key. The display shows DATA 0 after the initialization is complete.

■ SELECTING INPUT RANGE

[Example] Input range -5.0 to +5.0V

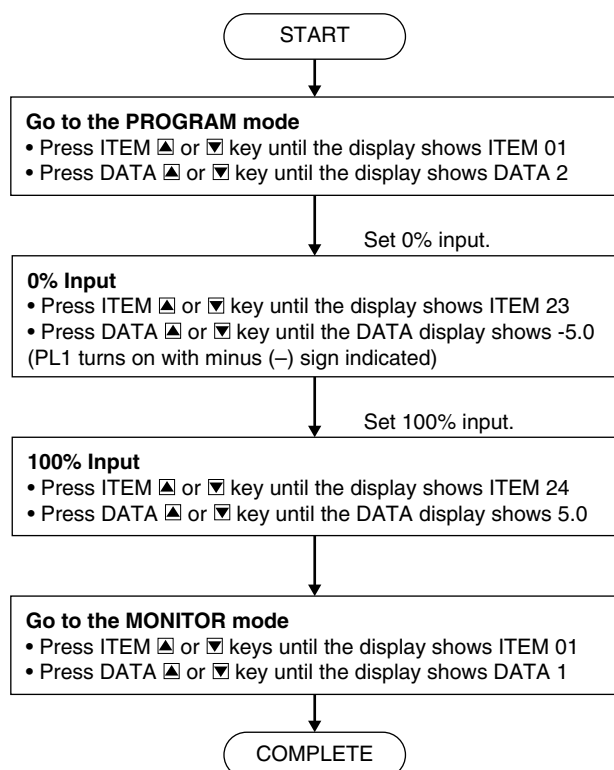

■ SELECTING OUTPUT RANGE

[Example 1] Output frequency range 0 to 5 kHz

Only "50% Duty Ratio" is selectable as pulse width range.

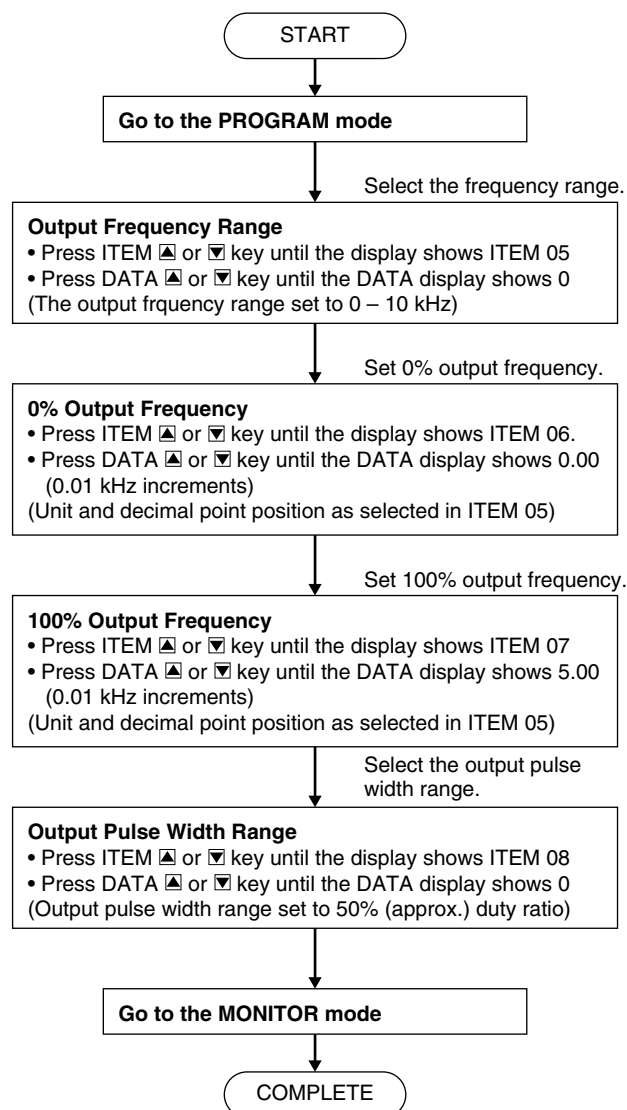

[Example 2] Output frequency range 0 to 10 Hz
One-shot pulse width 10 msec.

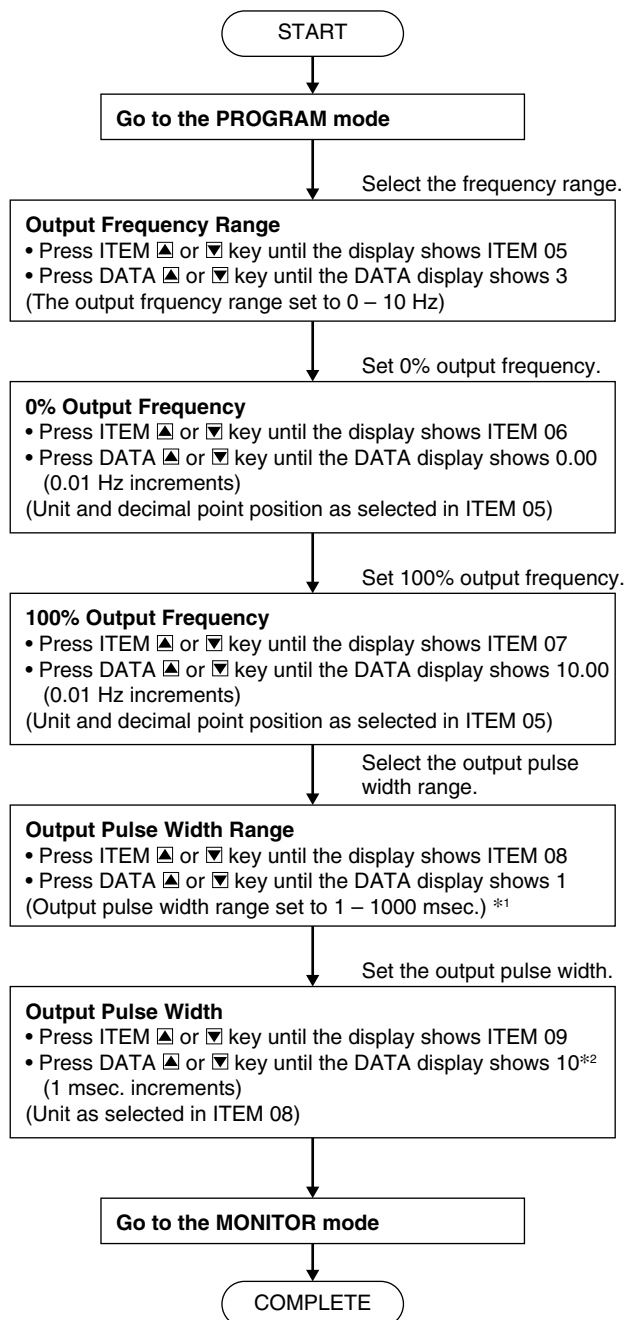

*1.

*2: 50 – 1000 msec. for AC/DC switch output.
If the selected pulse width is greater than the cycle at 115% output, the MXAP does not function adequately. (ITEM 09 data blinks with an abnormal setting.)

■ LOOP TEST OUTPUT

The loop test output is enabled when ITEM L (14) is selected in the PROGRAM mode.

[Example] Loop test output 90 Hz of 0 – 100 Hz range

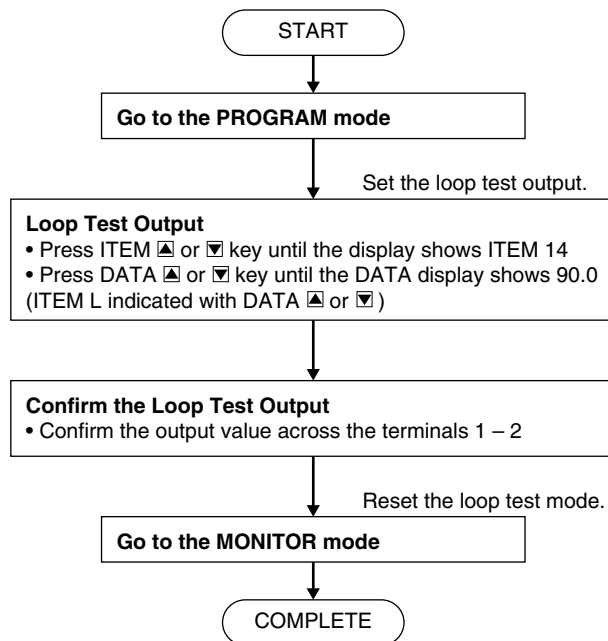

■ OUTPUT PULSE VOLTAGE

(Usable only for the voltage pulse output)

[Example] H Level 12V (L Level is fixed to ≤ 0.5V.)

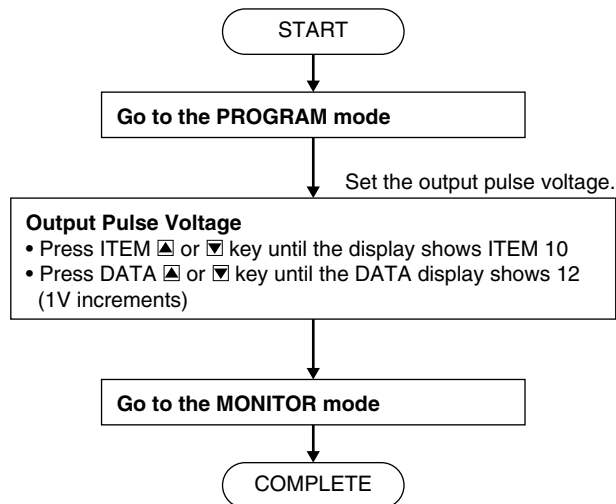
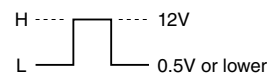

■ DISPLAY SCALING

[Example] Display range -6500 to +300

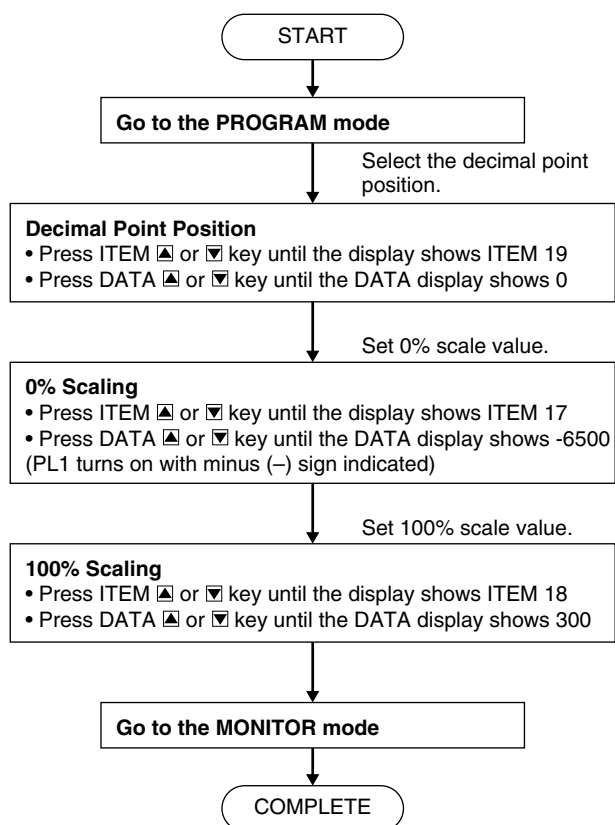

■ RESET ALL SETTINGS

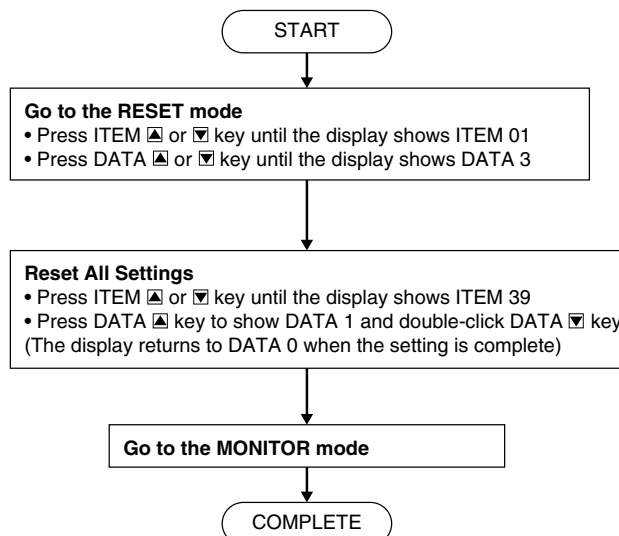

OUTPUT LOGIC

The output pulse logic is selectable. One-shot pulse width is applied at the bold line part of waveform. Arrows in the figure indicate the pulse edge which counts.

ITEM	DATA	PULSE LOGIC	VOLTAGE PULSE OUTPUT	OPEN COLLECTOR AC/DC SWITCH OUTPUT	RS-422 LINE DRIVER PULSE OUTPUT
12	0	Non-Inverted			
	1	Inverted			

RECALLING PAST TOTALIZED COUNT

Past totalized pulse counts at the moment of auto-reset can be recalled for five times.

For example, the totalized count during the period indicated with (5) in the figure below are recalled in one of the ITEM 27 (upper 4 digits) and 28 (lower 4 digits). Likewise, (1) through (4) are also recalled in ITEM 29 through 36.

The displayed are renewed by every auto resetting. If the auto-reset is not specified, this function is not valid.

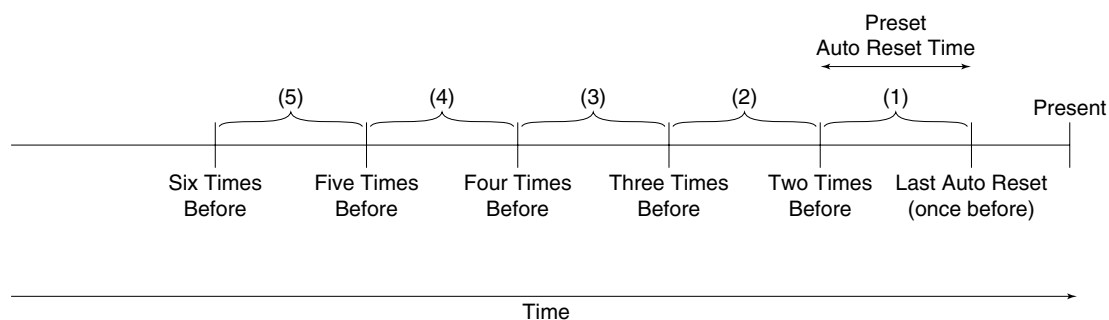

TERMINAL CONNECTIONS

Connect the unit as in the diagram below or refer to the connection diagram on the top of the unit.

When an input resistor is provided with the module, attach it together with input wiring to the input screw terminals.

EXTERNAL DIMENSIONS unit: mm (inch)

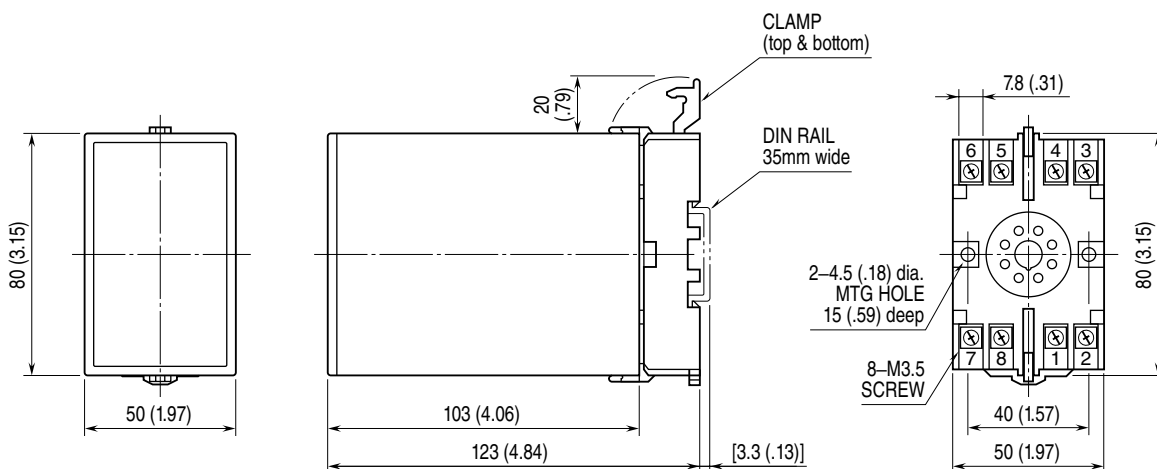

• When mounting, no extra space is needed between units.

CONNECTION DIAGRAM

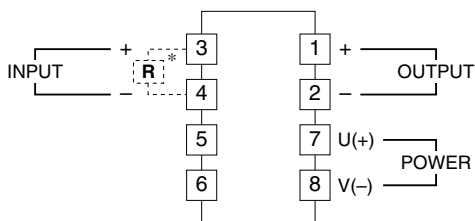

*Input shunt resistor attached for current input.

Output Connection Examples

Open Collector

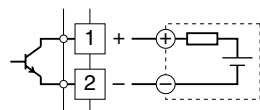

RS-422 Line Driver Pulse

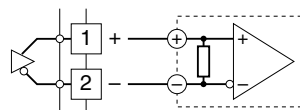

Voltage Pulse

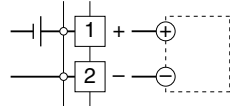

AC/DC Switch

AC Powered

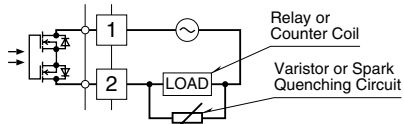

DC Powered

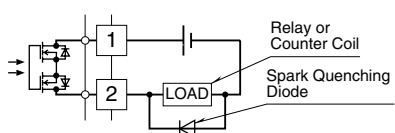

TERMINAL ASSIGNMENTS unit: mm (inch)

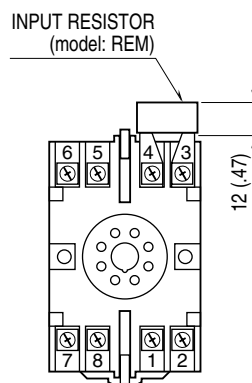

Input shunt resistor attached for current input.

CHECKING

- 1) Terminal wiring: Check that all cables are correctly connected according to the connection diagram.
- 2) Power input voltage: Check voltage across the terminal 7 – 8 with a multimeter.
- 3) Input: Check the input voltage (current) across the terminal 3 (+) – 4 (–) with a multimeter.
- 4) Output: Check that the load resistance meets the described specifications.

ADJUSTMENT PROCEDURE

For matching the signal to a receiving instrument or in case of regular calibration, proceed as follows.

Use a signal source and measuring instruments of sufficient accuracy level. Turn the power supply on and warm up for more than 10 minutes.

- 1) Turn the unit into Program mode.
- 2) Simulate 0% input and adjust the PV display to show 0.0 (ITEM 15).
- 3) Simulate 100% input and adjust the PV display to show 100.0 (ITEM 16).
- 4) Simulate 0% input again and check the PV display.
- 5) When the PV value is changed, repeat the above procedure 2) – 4).
- 6) Return the unit into Monitor mode.

MAINTENANCE

Regular calibration procedure is explained below:

■ CALIBRATION

Warm up the unit for at least 10 minutes. Apply 0%, 25%, 50%, 75% and 100% input signal. Check that the output signal for the respective input signal remains within accuracy described in the data sheet. When the output is out of tolerance, recalibrate the unit as explained earlier (ITEM 15 and 16).

LIGHTNING SURGE PROTECTION

We offer a series of lightning surge protector for protection against induced lightning surges. Please contact us to choose appropriate models.