

**BEFORE USE ....**

Thank you for choosing us. Before use, please check contents of the package you received as outlined below. If you have any problems or questions with the product, please contact our sales office or representatives.

**■ PACKAGE INCLUDES:**

Signal conditioner  
 (body + base socket + input resistor).....(1)  
 Input resistor is provided only with current input type.

**■ MODEL NO.**

Confirm Model No. marking on the product to be exactly what you ordered.

**■ INSTRUCTION MANUAL**

This manual describes necessary points of caution when you use this product, including installation, connection and basic maintenance procedures.

**POINTS OF CAUTION**

**■ POWER INPUT RATING & OPERATIONAL RANGE**

- Locate the power input rating marked on the product and confirm its operational range as indicated below:  
**AC power:** Rating  $\pm 10\%$ , 50/60  $\pm 2$  Hz, approx. 2VA  
**DC power:** Rating  $\pm 10\%$ , approx. 2W

**■ GENERAL PRECAUTIONS**

- Before you remove the unit from its base socket or mount it, turn off the power supply and input signal for safety.

**■ ENVIRONMENT**

- Indoor use.
- When heavy dust or metal particles are present in the air, install the unit inside proper housing with sufficient ventilation.
- Do not install the unit where it is subjected to continuous vibration. Do not subject the unit to physical impact.
- Environmental temperature must be within  $-5$  to  $+55^{\circ}\text{C}$  ( $23$  to  $131^{\circ}\text{F}$ ) with relative humidity within 30 to 90% RH in order to ensure adequate life span and operation.

**■ WIRING**

- Do not install cables close to noise sources (relay drive cable, high frequency line, etc.).
- Do not bind these cables together with those in which noises are present. Do not install them in the same duct.

**■ AND ....**

- The unit is designed to function as soon as power is supplied, however, a warm up for 10 minutes is required for satisfying complete performance described in the data sheet.

**COMPONENT IDENTIFICATION**

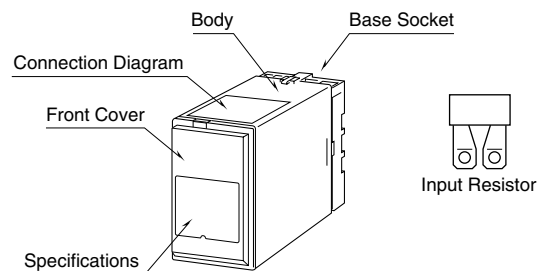

**■ HOW TO OPEN THE FRONT COVER:**

Hang your finger on the hook at the top of the front cover and pull.

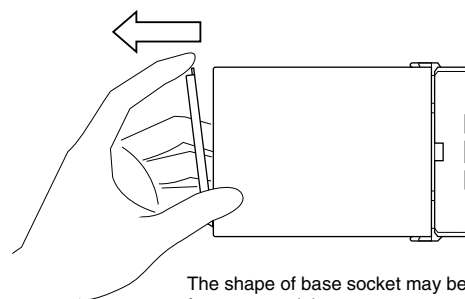

**■ FRONT PANEL CONFIGURATION**

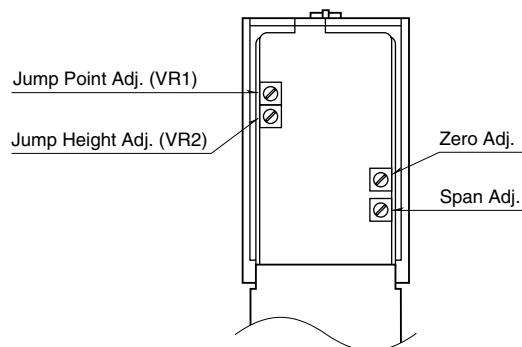

**• Explanations**

Use the Jump Point Adj. to set the jump point (1).  
 Use the Jump Height Adj. to set the jump height (2).

• **Settings**

Turning the Adj. clockwise moves the jump point/height toward 100%.

Turning the Adj. counterclockwise moves the jump point/height toward 0%.

The hysteresis of the jump-up point is approx. 3%.

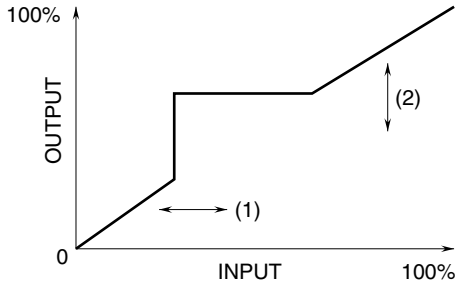

**INSTALLATION**

Detach the yellow clamps located at the top and bottom of the unit for separate the body from the base socket.

■ **DIN RAIL MOUNTING**

Set the base socket so that its DIN rail adaptor is at the bottom. Hang the upper hook at the rear side of base socket on the DIN rail and push in the lower. When removing the socket, push down the DIN rail adaptor utilizing a minus screwdriver and pull.

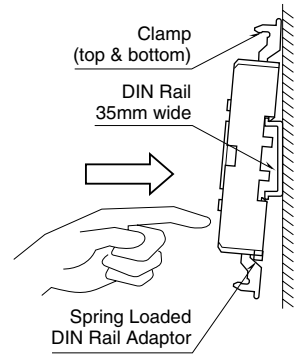

■ **WALL MOUNTING**

Refer to “EXTERNAL DIMENSIONS.”

Shape and size of the base socket are slightly different with various socket types.

**TERMINAL CONNECTIONS**

Connect the unit as in the diagram below or refer to the connection diagram on the top of the unit.

When an input resistor is provided with the module, attach it together with input wiring to the input screw terminals.

■ **EXTERNAL DIMENSIONS unit: mm (inch)**

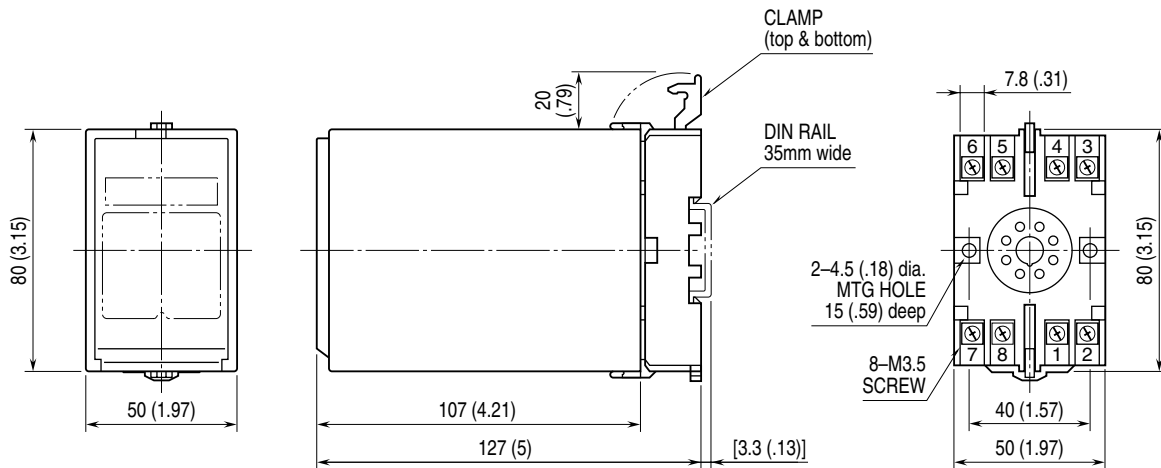

• When mounting, no extra space is needed between units.

■ **CONNECTION DIAGRAM**

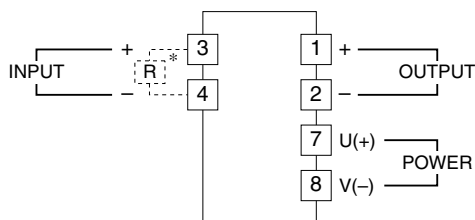

\*Input shunt resistor attached for current input.

■ **TERMINAL ASSIGNMENTS unit: mm (inch)**

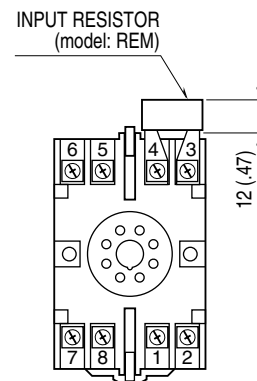

Input shunt resistor attached for current input.

---

## CHECKING

- 1) Terminal wiring: Check that all cables are correctly connected according to the connection diagram.
- 2) Power input voltage: Check voltage across the terminal 7 – 8 with a multimeter.
- 3) Input: Check that the input signal is within 0 – 100% of the full-scale.
- 4) Output: Check that the load resistance meets the described specifications.

---

## ADJUSTMENT PROCEDURE

This unit is calibrated at the factory to meet the ordered specifications, therefore you usually do not need any calibration.

For matching the signal to a receiving instrument or in case of regular calibration, adjust the output as explained in the following.

### ■ HOW TO CALIBRATE THE OUTPUT SIGNAL

Use a signal source and measuring instruments of sufficient accuracy level. Turn the power supply on and warm up for more than 10 minutes.

- 1) Turn VR1 and VR2 fully counterclockwise.
- 2) ZERO: Apply 0% input and adjust output to 0%.
- 3) SPAN: Apply 100% input and adjust output to 100%.
- 4) Check ZERO adjustment again with 0% input.
- 5) When ZERO value is changed, repeat the above procedure 2) – 4).

---

## MAINTENANCE

Regular calibration procedure is explained below:

### ■ CALIBRATION

Warm up the unit for at least 10 minutes. Turn VR1 and VR2 fully counterclockwise and apply 0%, 25%, 50%, 75% and 100% input signal. Check that the output signal for the respective input signal remains within accuracy described in the data sheet. When the output is out of tolerance, recalibrate the unit according to the “ADJUSTMENT PROCEDURE” explained earlier.

---

## LIGHTNING SURGE PROTECTION

We offer a series of lightning surge protector for protection against induced lightning surges. Please contact us to choose appropriate models.