

<b>DC ALARM</b> (thumbwheel switch adjustment; DPDT output)	MODEL <b>M2AS</b>
--	----------------------

### BEFORE USE ....

Thank you for choosing us. Before use, please check contents of the package you received as outlined below. If you have any problems or questions with the product, please contact our sales office or representatives.

#### ■ PACKAGE INCLUDES:

Signal conditioner  
 (body + base socket + input resistor).....(1)  
 Input resistor is provided only with current input type.

#### ■ MODEL NO.

Confirm Model No. marking on the product to be exactly what you ordered.

#### ■ INSTRUCTION MANUAL

This manual describes necessary points of caution when you use this product, including installation, connection and basic maintenance procedures.

### POINTS OF CAUTION

#### ■ CONFORMITY WITH EU DIRECTIVES

- This equipment is suitable for Pollution Degree 2, Measurement Category II (output, transient voltage 2500V) and Installation Category II (transient voltage 2500V). Reinforced insulation (signal input or output to power input: 300V) and basic insulation (signal input to output: 300V) are maintained. Prior to installation, check that the insulation class of this unit satisfies the system requirements.
- Altitude up to 2000 meters.
- The equipment must be mounted inside a panel.
- The equipment must be installed such that appropriate clearance and creepage distances are maintained to conform to CE requirements. Failure to observe these requirements may invalidate the CE conformance.
- The actual installation environments such as panel configurations, connected devices, connected wires, may affect the protection level of this unit when it is integrated in a panel system. The user may have to review the CE requirements in regard to the whole system and employ additional protective measures\* to ensure the CE conformity.
- \* For example, installation of noise filters and clamp filters for the power source, input and output connected to the unit, etc.
- Install lightning surge protectors for those wires connected to remote locations.

#### ■ POWER INPUT RATING & OPERATIONAL RANGE

- Locate the power input rating marked on the product and confirm its operational range as indicated below:  
 100 – 240V AC rating: 85 – 264V, 47 – 66 Hz, approx. 3 – 5VA  
 24V DC rating: 24V ±10%, approx. 3W  
 11 – 27V DC rating: 11 – 27V, approx. 3W  
 110V DC rating: 85 – 150V, approx. 3W

#### ■ GENERAL PRECAUTIONS

- Before you remove the unit from its base socket or mount it, turn off the power supply and input signal for safety.
- DO NOT apply excessive pressure on the thumbwheel switches.

#### ■ ENVIRONMENT

- Indoor use.
- When heavy dust or metal particles are present in the air, install the unit inside proper housing with sufficient ventilation.
- Do not install the unit where it is subjected to continuous vibration. Do not subject the unit to physical impact.
- Environmental temperature must be within -5 to +55°C (23 to 131°F) with relative humidity within 30 to 90% RH in order to ensure adequate life span and operation.
- Be sure that the ventilation slits are not covered with cables, etc.

#### ■ WIRING

- Do not install cables close to noise sources (relay drive cable, high frequency line, etc.).
- Do not bind these cables together with those in which noises are present. Do not install them in the same duct.

#### ■ AND ....

- The unit is designed to function as soon as power is supplied, however, a warm up for 10 minutes is required for satisfying complete performance described in the data sheet.

### COMPONENT IDENTIFICATION

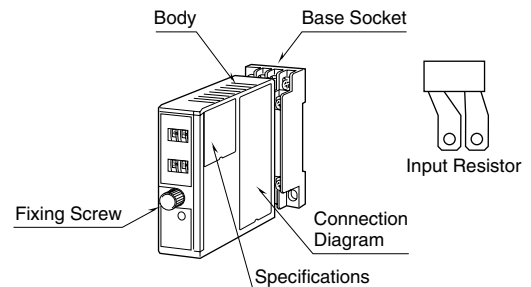

#### ■ FRONT PANEL CONFIGURATION

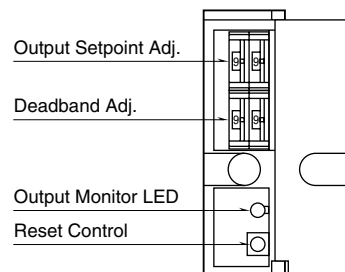

## INSTALLATION

Loosen the fixing screw at the front of the unit in order to separate the body from the base socket.

### ■ DIN RAIL MOUNTING

Set the base socket so that its DIN rail adaptor is at the bottom. Hang the upper hook at the rear side of base socket on the DIN rail and push in the lower. When removing the socket, push down the DIN rail adaptor utilizing a minus screwdriver and pull.

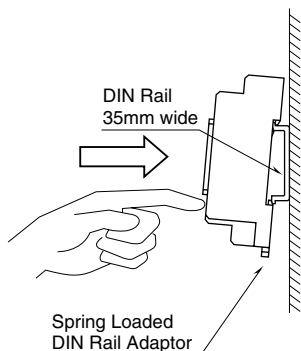

### ■ WALL MOUNTING

Refer to “EXTERNAL DIMENSIONS.”

## TERMINAL CONNECTIONS

Connect the unit as in the diagram below or refer to the connection diagram on the side of the unit.

When an input resistor is provided with the module, attach it together with input wiring to the input screw terminals.

### ■ EXTERNAL DIMENSIONS unit: mm (inch)

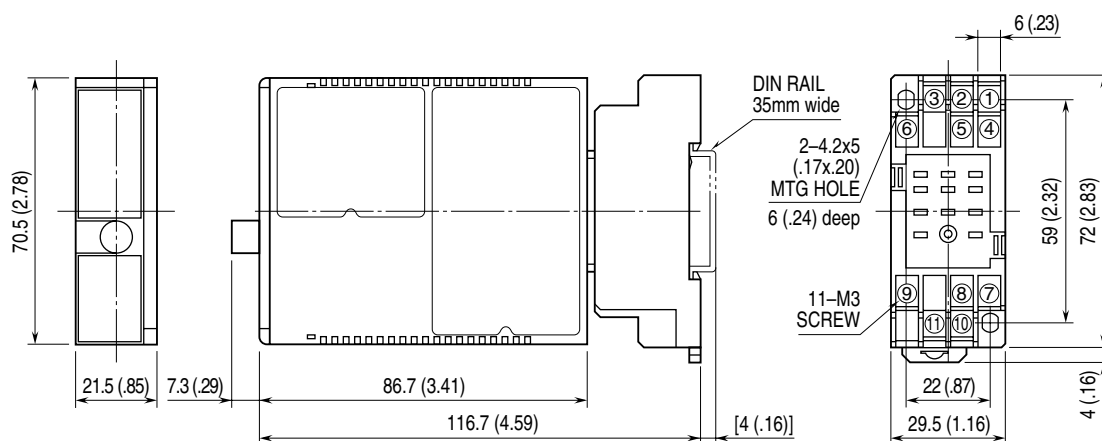

• When mounting, no extra space is needed between units.

### ■ CONNECTION DIAGRAM

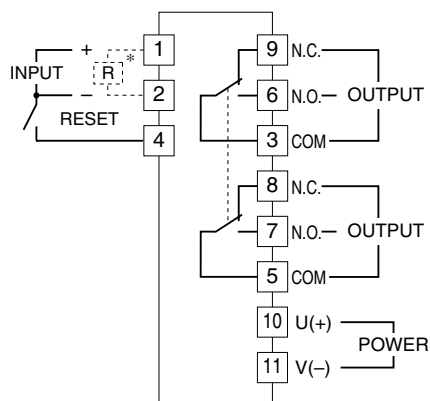

\*Input shunt resistor attached for current input.

### ■ TERMINAL ASSIGNMENTS unit: mm (inch)

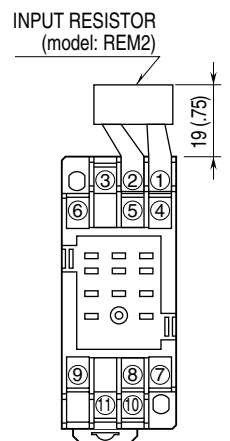

Input shunt resistor attached for current input.

## WIRING INSTRUCTIONS

### ■ SCREW TERMINAL

Torque: 0.8 N·m

### ■ SOLDERLESS TERMINAL

Refer to the drawing below for recommended ring tongue terminal size. Spade tongue type is also applicable.

Applicable wire size: 0.25 to 1.65 mm<sup>2</sup> (AWG 22 to 16)

Recommended manufacturer: Japan Solderless Terminal MFG.Co.Ltd, Nichifu Co.,Ltd

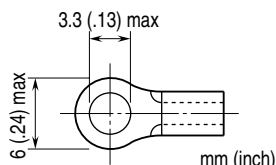

## CHECKING

- 1) Terminal wiring: Check that all cables are correctly connected according to the connection diagram.
- 2) Power input voltage: Check voltage across the terminal 10 – 11 with a multimeter.
- 3) Input: Check that the input signal is within 0 – 100% of the full-scale.
- 4) Alarm operations: Check the alarm operations referring to the figure below.
- 5) Output load: Check that the output load is 250V AC/600VA (360VA with enclosed relay) or 30V DC/150W at the maximum. For maximum relay life with inductive loads, external protection is recommended.

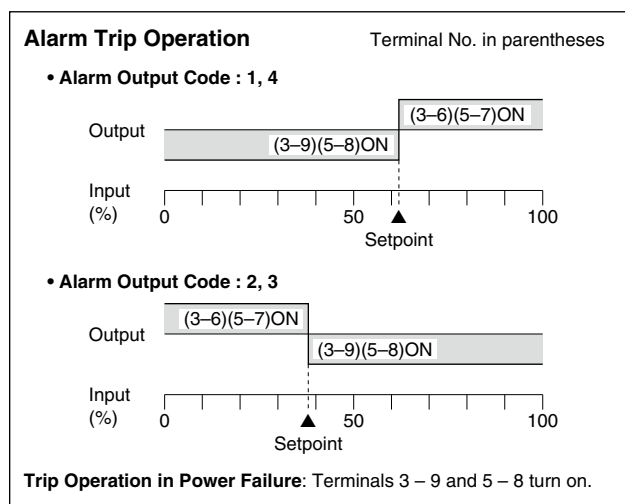

## SETPOINT ADJUSTMENTS

Turn the thumbwheel switches until desired figures in percent are shown. The output operation is set to “Latching” when the Deadband Adj. is set to 00. Monitor LED turns on when the coil is energized ([input] > [setpoint] for Codes 1 or 4, [input] < [setpoint] for Codes 2 or 3). The two transfer contacts trip at the same time when the signal input goes across the threshold.

## MAINTENANCE

Regular calibration procedure is explained below:

### ■ CALIBRATION

Warm up the unit for at least 10 minutes.

#### • Hi Alarm

Increase the input signal from a value lower than the setpoint and check that the relay trips at the setpoint.

#### • Lo Alarm

Decrease the input signal from a value higher than the setpoint and check that the relay trips at the setpoint.

When the trip points are shifted, please contact our sales office or representatives.

## LIGHTNING SURGE PROTECTION

We offer a series of lightning surge protector for protection against induced lightning surges. Please contact us to choose appropriate models.