

**CONTENTS**

|   |           |
|---|-----------|
| <b>1. BEFORE USE .....</b>  | <b>2</b>  |
| <b>2. GENERAL DESCRIPTION .....</b>                                 | <b>2</b>  |
| <b>3. POINTS OF CAUTION.....</b>                                    | <b>3</b>  |
| <b>4. HARDWARE SPECIFICATIONS .....</b>                             | <b>3</b>  |
| 4.1. M2BC-x1 (suffix codes 04, 08, or 16 in x) .....                | 3         |
| 4.2. M2BC-x2 (suffix codes 04, 08, or 16 in x).....                 | 4         |
| <b>5. COMPONENT IDENTIFICATIONS &amp; HARDWARE ADJUSTMENTS.....</b> | <b>5</b>  |
| 5.1. M2BC-x1 .....  | 5         |
| 5.2. M2BC-x2.....   | 5         |
| 5.3. COMMUNICATION CONTROLLER MODULE .....                          | 6         |
| <b>6. EXTERNAL DIMENSIONS unit: mm (inch) .....</b>                 | <b>7</b>  |
| 6.1. M2BC-x1 .....  | 7         |
| 6.2. M2BC-x2.....   | 8         |
| 6.3. MOUNTING REQUIREMENTS unit: mm (inch) .....                    | 10        |
| <b>7. CONNECTING DATA LINK WIRES.....</b>                           | <b>10</b> |
| 7.1. TWISTED-PAIR CABLE .....                                       | 10        |
| 7.2. POINTS OF CAUTION IN HANDLING WIRES .....                      | 10        |
| 7.3. WIRING DIAGRAM .....   | 10        |
| <b>8. CONNECTING WIRES .....</b>                                    | <b>11</b> |
| 8.1. POINTS OF CAUTION .....  | 11        |
| 8.2. WIRING EXAMPLES OF M2BC-x1 .....                               | 11        |
| 8.3. WIRING EXAMPLES OF M2BC-x2.....                                | 11        |
| <b>9. I/O SIGNALS .....</b>   | <b>12</b> |
| 9.1. REMOTE I/O .....   | 12        |
| 9.2. ASSIGNING REMOTE REGISTERS.....                                | 12        |
| 9.3. A/D CONVERSION.....  | 13        |
| <b>10. PARAMETERS SETTING BY PLC PROGRAM .....</b>                  | <b>14</b> |
| 10.1. GENERAL DESCRIPTION .....                                     | 14        |
| <b>11. TROUBLESHOOTING.....</b>                                     | <b>15</b> |
| 11.1. L ERR. INDICATOR BLINKING .....                               | 15        |
| 11.2. L ERR. INDICATOR ON.....                                      | 15        |
| 11.3. L RUN INDICATOR OFF.....                                      | 15        |
| 11.4. UNABLE TO READ/WRITE DIGITAL VALUES? .....                    | 15        |
| 11.5. I/O ZERO & SPAN NEED ADJUSTMENTS? .....                       | 15        |
| <b>12. LIGHTNING SURGE PROTECTION .....</b>                         | <b>15</b> |

## 1. BEFORE USE ....

Thank you for choosing us. Before use, please check contents of the package you received as outlined below. If you have any problems or questions with the product, please contact our sales office or representatives.

### ■ PACKAGE INCLUDES:

Communication controller ..... (1)  
Terminating resistor (110 Ω, 0.5 W)..... (1)

### ■ MODEL NO.

Confirm Model No. marking on the product to be exactly what you ordered.

### ■ INSTRUCTION MANUAL

This manual describes necessary points of caution when you use this product, including installation, connection and basic maintenance procedures.

## 2. GENERAL DESCRIPTION

The model M2BC is an I/O Terminal Block for CC-Link. Variety of input and output types can be mixed, selected from Mini-M series signal conditioners.

Model number and suffix codes are designated as follows:

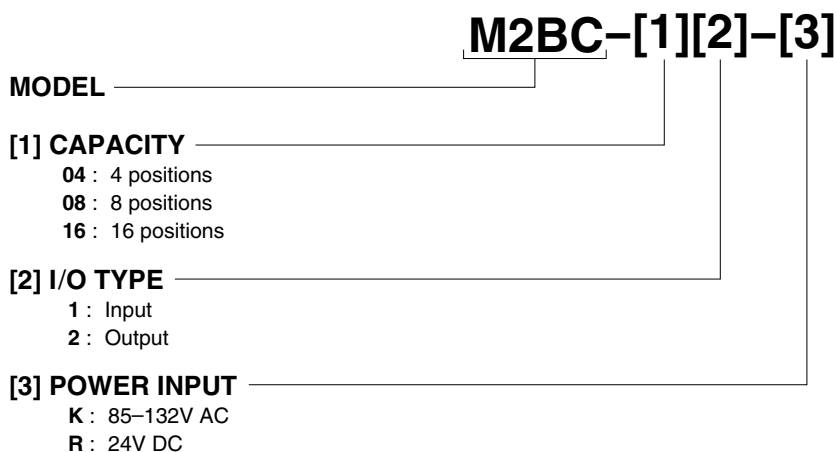

The Communication Controller Module of an Input Terminal Block converts analog inputs (0 – 100%) proportionally into 16-bit signed binary signals. The one for an Output Terminal Block converts 16-bit signed binary signals proportionally into analog outputs (0 – 100%).

This instruction manual explains hardware specifications, component identification, and wiring instructions, etc.

### 3. POINTS OF CAUTION

#### ■ POWER INPUT RATING & OPERATIONAL RANGE

- Refer to signal conditioner data sheet. Choose the same power input specification for all units.

#### ■ GENERAL PRECAUTIONS

- Before you remove the unit from its base or mount it, turn off the power supply and input signal for safety.

#### ■ ENVIRONMENT

- Indoor use.
- When heavy dust or metal particles are present in the air, install the unit inside proper housing with sufficient ventilation.
- Do not install the unit where it is subjected to continuous vibration. Do not subject the unit to physical impact.
- Environmental temperature must be within -5 to +55°C (23 to 131°F) with relative humidity within 30 to 90% RH in order to ensure adequate life span and operation.
- Be sure that the ventilation slits are not covered with cables, etc.

#### ■ WIRING

- Do not install cables close to noise sources (relay drive cable, high frequency line, etc.).
- Do not bind these cables together with those in which noises are present. Do not install them in the same duct.

#### ■ AND ....

- The unit is designed to function as soon as power is supplied, however, a warm up for 10 minutes is required for satisfying complete performance described in the data sheet.

### 4. HARDWARE SPECIFICATIONS

#### 4.1. M2BC-x1 (suffix codes 04, 08, or 16 in x)

| ITEM                         | SPECIFICATIONS   |   |
|------------------------------|--|---|
| Analog input                 | Refer to the data sheets for Mini-M series Signal Conditioners.        |   |
| Protocol                     | CC-Link, Ver.1.10  |   |
| Digital output               | 16-bit signed binary (14 bits for data)                                |   |
| I/O characteristics          | 0 – 10000 proportional to analog input 0 – 100%                        |   |
| Maximum resolution           | 1mV for 1 – 5V DC range  |   |
| Accuracy                     | ≤ ±0.1% excluding the accuracy of I/O modules                          |   |
| Maximum input voltage        | Refer to the data sheets for Mini-M series Signal Conditioners.        |   |
| No. of analog input channels | M2BC-041   | 4   |
|                              | M2BC-081   | 8   |
|                              | M2BC-161   | 16  |
| Isolation                    | Input to CC-Link to power to FG1 (isolated between channels)           |   |
| Required nodes               | M2BC-041   | 1 (RX/RX 32 points each, RWr/RWw each 4 points)   |
|                              | M2BC-081   | 2 (RX/RX 64 points each*, RWr/RWw each 8 points)  |
|                              | M2BC-161   | 4 (RX/RX 128 points each*, RWr/RWw each 16 points)  |
| Connection                   | CC-Link  | Euro type connector terminal (applicable wire size: 0.2 – 2.5 mm <sup>2</sup> , stripped length 7 mm) |
|                              | Input  | M3 screw terminals (torque 0.8 N·m)   |
|                              | Power input  | M3 screw terminals (torque 0.8 N·m)   |
| Mounting screw for the base  | M5 × 6 mm or larger  |   |
| Noise immunity               | 500V p-p, 1μsec.   |   |
| Dielectric strength          | 1000V AC @ 1 minute (power to input module to CC-Link module to FG1)   |   |
| Insulation resistance        | ≥ 100 MΩ with 500V DC (power to input module to CC-Link module to FG1) |   |
| Weight                       | M2BC-041   | 1.2 kg (2.6 lb)   |
|                              | M2BC-081   | 1.5 kg (3.3 lb)   |
|                              | M2BC-161   | 2.0 kg (4.4 lb)   |
| Power input                  | M2BC-x1-K  | 85 – 132V AC, 47 – 66 Hz  |
|                              | M2BC-x1-R  | 24V DC ±10%   |
| Power consumption            | M2BC-x1-K  | approx. 6VA without I/O modules   |
|                              | M2BC-041-K   | approx. 30VA with 4 modules (M2DY)  |
|                              | M2BC-081-K   | approx. 50VA with 8 modules (M2DY)  |
|                              | M2BC-161-K   | approx. 90VA with 16 modules (M2DY)   |
| Current consumption          | M2BC-x1-R  | approx. 0.25A without I/O modules   |
|                              | M2BC-041-R   | approx. 1A with 4 modules (M2DY)  |
|                              | M2BC-081-R   | approx. 1.5A with 8 modules (M2DY)  |
|                              | M2BC-161-R   | approx. 2.5A with 16 modules (M2DY)   |

\* The area that is used as M2BC is 32 points.

Regardless of the number of nodes, the M2BC uses 32 bits assigned to each of input and output for sending to/receiving from the Master Unit.

## 4.2. M2BC-x2 (suffix codes 04, 08, or 16 in x)

| ITEM                         | SPECIFICATIONS  |   |
|------------------------------|---|---|
| Analog output                | Refer to the data sheets for Mini-M series Signal Conditioners.         |   |
| Protocol                     | CC-Link, Ver.1.10   |   |
| Digital input                | 16-bit signed binary (14 bits for data)                                 |   |
| I/O characteristics          | 0 – 10000 proportional to analog output 0 – 100%                        |   |
| Maximum resolution           | 1mV for 1 – 5V DC range   |   |
| Accuracy                     | ≤ ±0.1% excluding the accuracy of I/O modules                           |   |
| Maximum output voltage       | Refer to the data sheets for Mini-M series Signal Conditioners.         |   |
| No. of analog input channels | M2BC-042  | 4   |
|                              | M2BC-082  | 8   |
|                              | M2BC-162  | 16  |
| Isolation                    | Output to CC-Link to power to FG1 (isolated between channels)           |   |
| Required nodes               | M2BC-042  | 1 (RX/RV 32 points each, RWr/RWw each 4 points)   |
|                              | M2BC-082  | 2 (RX/RV 64 points each*, RWr/RWw each 8 points)  |
|                              | M2BC-162  | 4 (RX/RV 128 points each*, RWr/RWw each 16 points)  |
| Connection                   | CC-Link   | Euro type connector terminal (applicable wire size: 0.2 – 2.5 mm <sup>2</sup> , stripped length 7 mm) |
|                              | Output  | M3 screw terminals (torque 0.8 N·m)   |
|                              | Power input   | M3 screw terminals (torque 0.8 N·m)   |
| Mounting screw for the base  | M5 × 6 mm or larger   |   |
| Noise immunity               | 500V p-p, 1μsec.  |   |
| Dielectric strength          | 1000V AC @ 1 minute (power to output module to CC-Link module to FG1)   |   |
| Insulation resistance        | ≥ 100 MΩ with 500V DC (power to output module to CC-Link module to FG1) |   |
| Weight                       | M2BC-042  | 1.2 kg (2.6 lb)   |
|                              | M2BC-082  | 1.5 kg (3.3 lb)   |
|                              | M2BC-162  | 2.0 kg (4.4 lb)   |
| Power input                  | M2BC-x2-K   | 85 – 132V AC, 47 – 66 Hz  |
|                              | M2BC-x2-R   | 24V DC ±10%   |
| Power consumption            | M2BC-x2-K   | approx. 6VA without I/O modules   |
|                              | M2BC-042-K  | approx. 30VA with 4 modules (M2DY)  |
|                              | M2BC-082-K  | approx. 50VA with 8 modules (M2DY)  |
|                              | M2BC-162-K  | approx. 90VA with 16 modules (M2DY)   |
| Current consumption          | M2BC-x2-R   | approx. 0.25A without I/O modules   |
|                              | M2BC-042-R  | approx. 1A with 4 modules (M2DY)  |
|                              | M2BC-082-R  | approx. 1.5A with 8 modules (M2DY)  |
|                              | M2BC-162-R  | approx. 2.5A with 16 modules (M2DY)   |

\* The area that is used as M2BC is 32 points.

Regardless of the number of nodes, the M2BC uses 32 bits assigned to each of input and output for sending to/receiving from the Master Unit.

## 5. COMPONENT IDENTIFICATIONS & HARDWARE ADJUSTMENTS

### 5.1. M2BC-x1

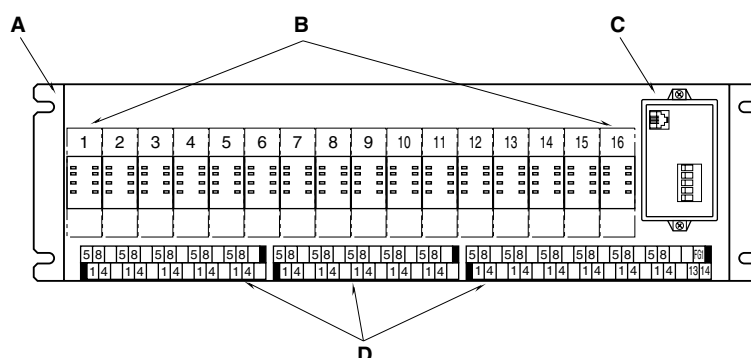

| REF. | NAME                            | FUNCTION                                |
|------|---------------------------------|---|
| A    | Base                            | Installation base                       |
| B    | Base socket                     | Mounting Mini-M modules                 |
| C    | Communication Controller Module | Interfacing field I/Os with CC-Link     |
| D    | Terminal blocks                 | Connecting field inputs and power input |

Note: The above figure indicates model M2BC-161.

### 5.2. M2BC-x2

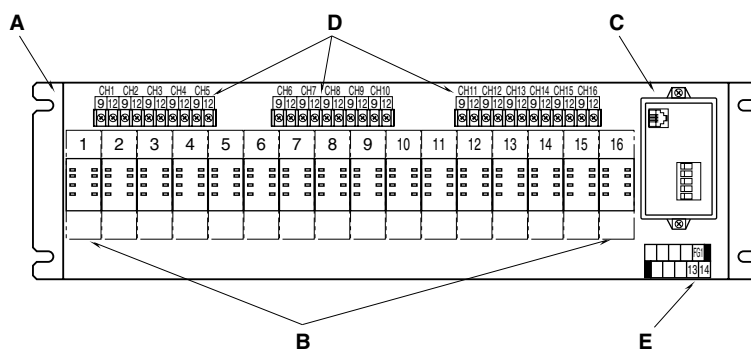

| REF. | NAME                            | FUNCTION                            |
|------|---------------------------------|-------------------------------------|
| A    | Base                            | Installation base                   |
| B    | Base socket                     | Mounting Mini-M modules             |
| C    | Communication Controller Module | Interfacing field I/Os with CC-Link |
| D    | Output terminal blocks          | Connecting field outputs            |
| E    | Power input terminal block      | Connecting power input              |

Note: The above figure indicates model M2BC-162.

## 5.3. COMMUNICATION CONTROLLER MODULE

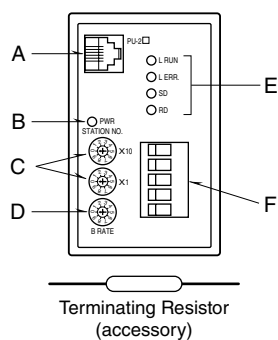

|                  | NAME   | FUNCTIONS                                      |  |
|------------------|--|--|--|
| A                | Modular jack for factory calibration                   | Used only for factory calibration.             |  |
| B                | Power LED  | MARKING (color)                                | FUNCTIONS  |
|                  |  | PWR (green)                                    | ON: Power is supplied.<br>OFF: Power is not supplied.  |
| C                | Station No. setting                                    | Selectable within 1 – 64. (factory set to: 00) |  |
| D                | Baud rate setting                                      | SETTING  | BAUD RATE  |
|                  |  | 0  | 156 kbps (factory default)   |
|                  |  | 1  | 625 kbps   |
|                  |  | 2  | 2.5 Mbps   |
|                  |  | 3  | 5 Mbps   |
|                  |  | 4  | 10 Mbps  |
| Other than 0 – 4 | Not valid;<br>L ERR. turns on as a transmission error. |  |  |
| E                | Status indicator LED                                   | MARKING (color)                                | FUNCTIONS  |
|                  |  | L RUN (red)                                    | ON: normal communication<br>OFF: communication down (time-out error)                         |
|                  |  | L ERR. (red)                                   | ON: transmission data error<br>Blinking: transmission data error<br>OFF: normal transmission |
|                  |  |  | SD (red)   |
|                  |  | RD (red)                                       | ON when receiving  |
| F                | Euro type connector terminal for CC-Link               | For wiring to CC-Link                          |  |

## 6. EXTERNAL DIMENSIONS unit: mm (inch)

### 6.1. M2BC-x1

#### ■ M2BC-041

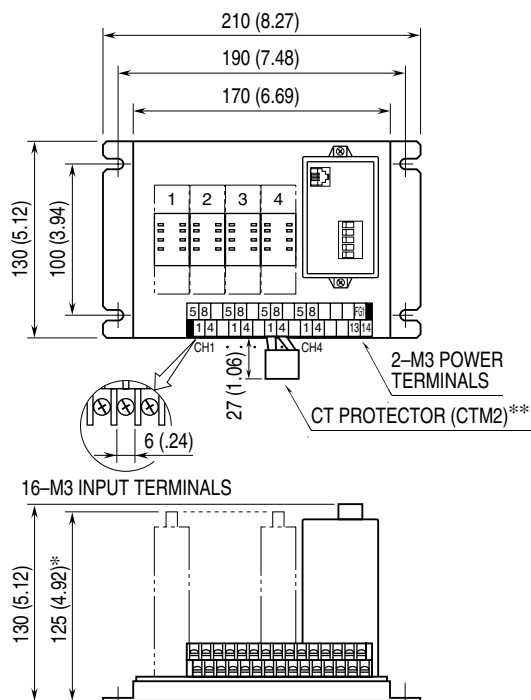

\* 165 (6.50) required for pneumatic tubing for M2PV.  
 \*\* Attached to M2CA and M2CE.

#### ■ M2BC-081

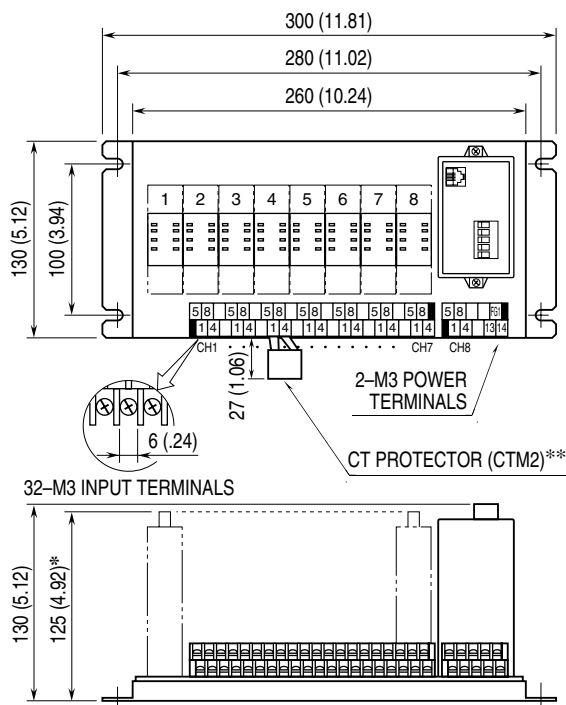

\* 165 (6.50) required for pneumatic tubing for M2PV.  
 \*\* Attached to M2CA and M2CE.

■ M2BC-161

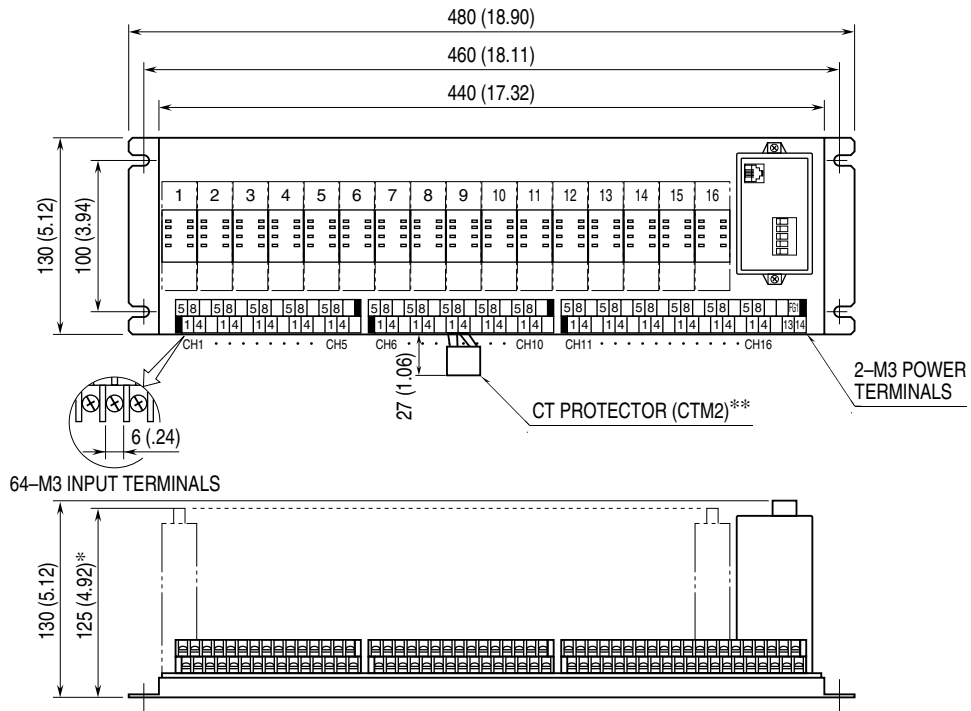

\* 165 (6.50) required for pneumatic tubing for M2PV.  
 \*\* Attached to M2CA and M2CE.

6.2. M2BC-x2

■ M2BC-042

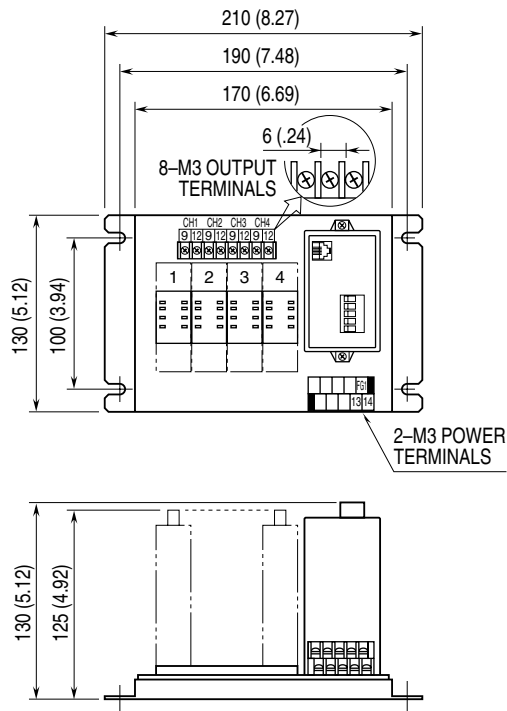



■ M2BC-082

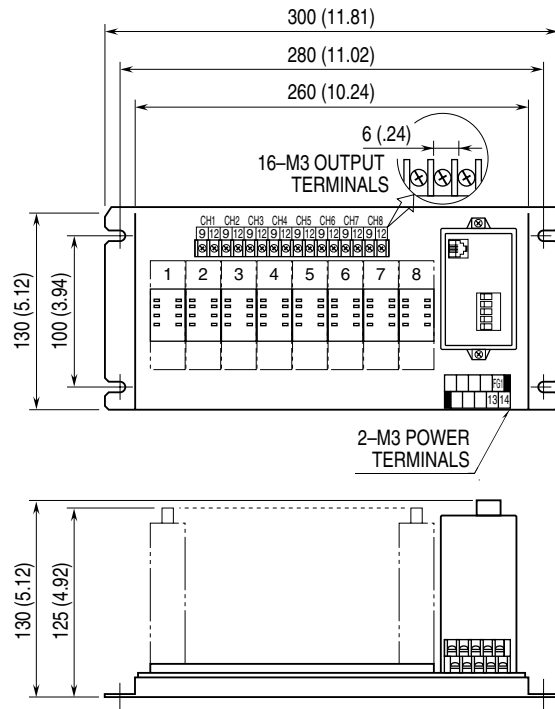

■ M2BC-162

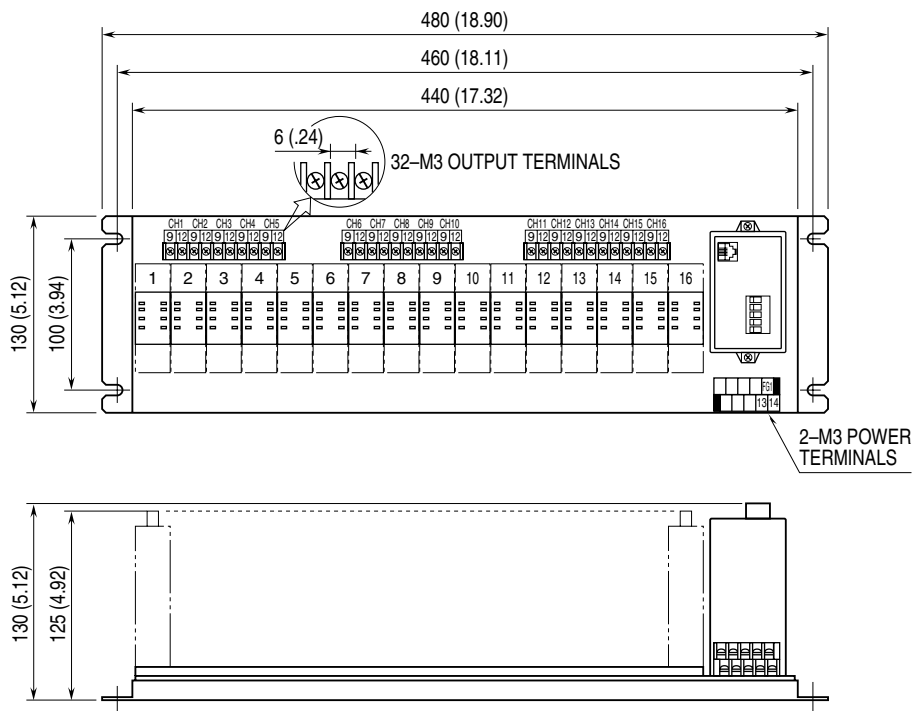

### 6.3. MOUNTING REQUIREMENTS unit: mm (inch)

#### ■ M2BC-04x

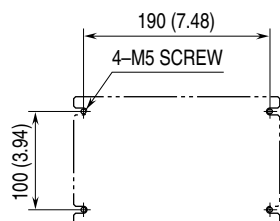

#### ■ M2BC-08x

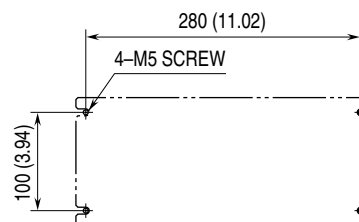

#### ■ M2BC-16x

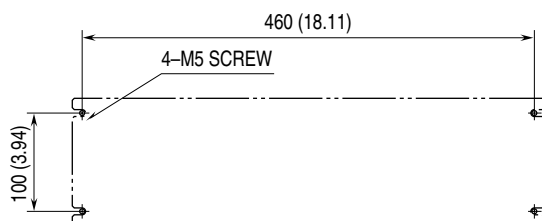

## 7. CONNECTING DATA LINK WIRES

The following explanations apply to the twisted-pair cables connecting the M2BC to the Master Unit.

### 7.1. TWISTED-PAIR CABLE

The following types of wire are recommended for connecting the M2BC to the Master Unit.

KURAMO ELECTRIC FANC-SB 0.5 mm<sup>2</sup> × 3 or equivalent

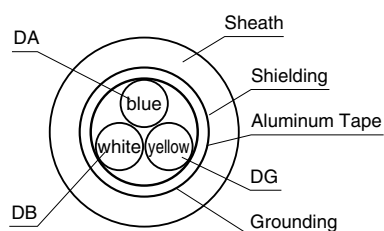

### 7.2. POINTS OF CAUTION IN HANDLING WIRES

DO NOT apply extraordinary forces to the wires as explained in the following:

- 1) DO NOT SQUEEZE the wires with a sharp-edged tool.
- 2) DO NOT TWIST the wires extraordinarily.
- 3) DO NOT PULL the wires extraordinarily tight.
- 4) DO NOT TRAMPLE on the wires.
- 5) DO NOT PUT objects onto the wires.
- 6) DO NOT DAMAGE the insulation tube of wires.

### 7.3. WIRING DIAGRAM

Connect the M2BC to the Master Unit as shown below.

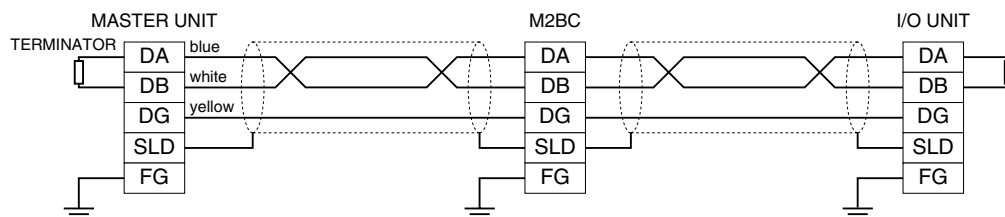

## 8. CONNECTING WIRES

This section explains points of caution when wiring I/O modules and examples of wiring diagrams.

### 8.1. POINTS OF CAUTION

Appropriate precautions are required such as follows for protecting the system from external noise interference:

- 1) Separate analog I/O and communication wires from others in order to prevent surge or induction noises.
- 2) Separate power input wires (AC) from those for driving motors.
- 3) Do not install these wires next to main supply circuits or high voltage cables.  
Never bind them to these circuits.
- 4) Ground the shield of communication wires at one point.  
Consideration about locations of the ground may be necessary according to external noise interference.

### 8.2. WIRING EXAMPLES OF M2BC-x1

#### 1) Input Signal

The terminal No. marked on the Input Terminal Block are the same as those marked on individual Mini-M series I/O Signal Conditioners. Refer to data sheets for the I/O modules when wiring each module.

Typical wiring diagrams are shown in the following:

#### ■ DC VOLTAGE (model: M2VS)

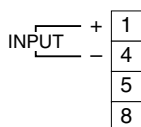

#### ■ DC CURRENT (model: M2VS)

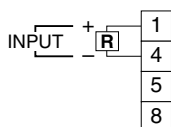

#### ■ THERMOCOUPLE (model: M2TS) comp. leadwire

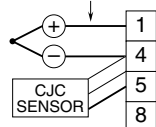

#### ■ RTD (model: M2RS)

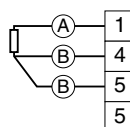

#### ■ POTENTIOMETER (model: M2MS)

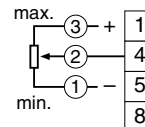

#### 2) Power Input

#### ■ AC POWER INPUT

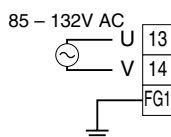

#### ■ DC POWER INPUT

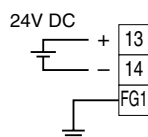

### 8.3. WIRING EXAMPLES OF M2BC-x2

#### 1) Output Signal

The terminal No. marked on the Output Terminal Block are the same as those marked on individual Mini-M series I/O Signal Conditioners. Refer to data sheets for the I/O modules when wiring each module.

Output range may be different between modules even though all output signals are connected to the 9 (+) – 12 (-) terminals.

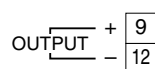

#### 2) Power Input

#### ■ AC POWER INPUT

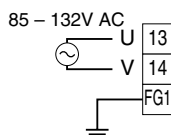

#### ■ DC POWER INPUT

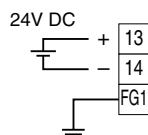

## 9. I/O SIGNALS

### 9.1. REMOTE I/O

The M2BC occupies from 1 up to 4 nodes according to the number of I/O channels. Regardless of the number of nodes, 32 bits are assigned to each of input and output for sending to/receiving from the Master Unit. One (1) bit among RXxB\* is used as remote device (M2BC) READY signal, turned ON when the M2BC is in normal operation.

\*.  $x = (\text{Station No.} \times 2 - 1) \text{H}$

[example] Station No. = 9

$9 \times 2 - 1 = 17 \times 11\text{H}$

READY signal is input at RX11B.

### 9.2. ASSIGNING REMOTE REGISTERS

#### (1) M2BC-x1

The M2BC-x1 does not use the remote registers for the direction from the Master to Remote (RWwn to RWwn+15).

The table below shows the data assignment of those for the direction from the Remote to Master.

| DIRECTION           | ADDRESS   | CONTENTS              | M2BC-041 | M2BC-081 | M2BC-161 | DEFAULT |
|---------------------|-----------|-----------------------|----------|----------|----------|---------|
| M2BC<br>↓<br>Master | RWrn + 0  | Ch. 1 digital output  | ✓        | ✓        | ✓        | 0       |
|                     | RWrn + 1  | Ch. 2 digital output  | ✓        | ✓        | ✓        | 0       |
|                     | RWrn + 2  | Ch. 3 digital output  | ✓        | ✓        | ✓        | 0       |
|                     | RWrn + 3  | Ch. 4 digital output  | ✓        | ✓        | ✓        | 0       |
|                     | RWrn + 4  | Ch. 5 digital output  |          | ✓        | ✓        | 0       |
|                     | RWrn + 5  | Ch. 6 digital output  |          | ✓        | ✓        | 0       |
|                     | RWrn + 6  | Ch. 7 digital output  |          | ✓        | ✓        | 0       |
|                     | RWrn + 7  | Ch. 8 digital output  |          | ✓        | ✓        | 0       |
|                     | RWrn + 8  | Ch. 9 digital output  |          |          | ✓        | 0       |
|                     | RWrn + 9  | Ch. 10 digital output |          |          | ✓        | 0       |
|                     | RWrn + 10 | Ch. 11 digital output |          |          | ✓        | 0       |
|                     | RWrn + 11 | Ch. 12 digital output |          |          | ✓        | 0       |
|                     | RWrn + 12 | Ch. 13 digital output |          |          | ✓        | 0       |
|                     | RWrn + 13 | Ch. 14 digital output |          |          | ✓        | 0       |
|                     | RWrn + 14 | Ch. 15 digital output |          |          | ✓        | 0       |
|                     | RWrn + 15 | Ch. 16 digital output |          |          | ✓        | 0       |

#### (2) M2BC-x2

The M2BC-x2 does not use the remote registers for the direction from the Remote to Master (RWrn to RWrn+15).

The table below shows the data assignment of those for the direction from the Master to Remote.

| DIRECTION           | ADDRESS   | CONTENTS             | M2BC-042 | M2BC-082 | M2BC-162 | DEFAULT |
|---------------------|-----------|----------------------|----------|----------|----------|---------|
| Master<br>↓<br>M2BC | RWrn + 0  | Ch. 1 digital input  | ✓        | ✓        | ✓        | 0       |
|                     | RWrn + 1  | Ch. 2 digital input  | ✓        | ✓        | ✓        | 0       |
|                     | RWrn + 2  | Ch. 3 digital input  | ✓        | ✓        | ✓        | 0       |
|                     | RWrn + 3  | Ch. 4 digital input  | ✓        | ✓        | ✓        | 0       |
|                     | RWrn + 4  | Ch. 5 digital input  |          | ✓        | ✓        | 0       |
|                     | RWrn + 5  | Ch. 6 digital input  |          | ✓        | ✓        | 0       |
|                     | RWrn + 6  | Ch. 7 digital input  |          | ✓        | ✓        | 0       |
|                     | RWrn + 7  | Ch. 8 digital input  |          | ✓        | ✓        | 0       |
|                     | RWrn + 8  | Ch. 9 digital input  |          |          | ✓        | 0       |
|                     | RWrn + 9  | Ch. 10 digital input |          |          | ✓        | 0       |
|                     | RWrn + 10 | Ch. 11 digital input |          |          | ✓        | 0       |
|                     | RWrn + 11 | Ch. 12 digital input |          |          | ✓        | 0       |
|                     | RWrn + 12 | Ch. 13 digital input |          |          | ✓        | 0       |
|                     | RWrn + 13 | Ch. 14 digital input |          |          | ✓        | 0       |
|                     | RWrn + 14 | Ch. 15 digital input |          |          | ✓        | 0       |
|                     | RWrn + 15 | Ch. 16 digital input |          |          | ✓        | 0       |

### 9.3. A/D CONVERSION

#### (1) M2BC-x1

Analog input signal (0 – 100%) from Mini-M Signal Conditioners is converted proportionally into digital data, provided to the Master Unit.

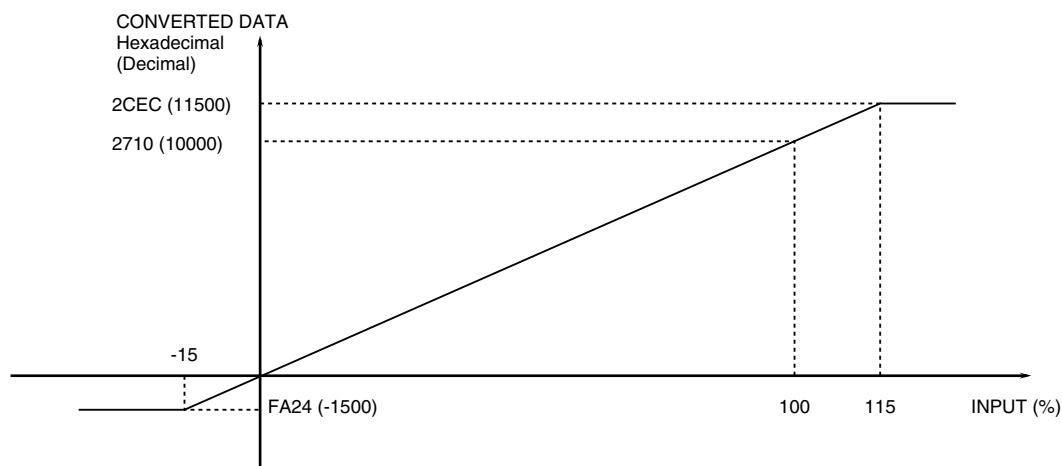

#### (2) M2BC-x2

Digital input signal from the Master Unit is converted proportionally into analog output signal (0 – 100%).

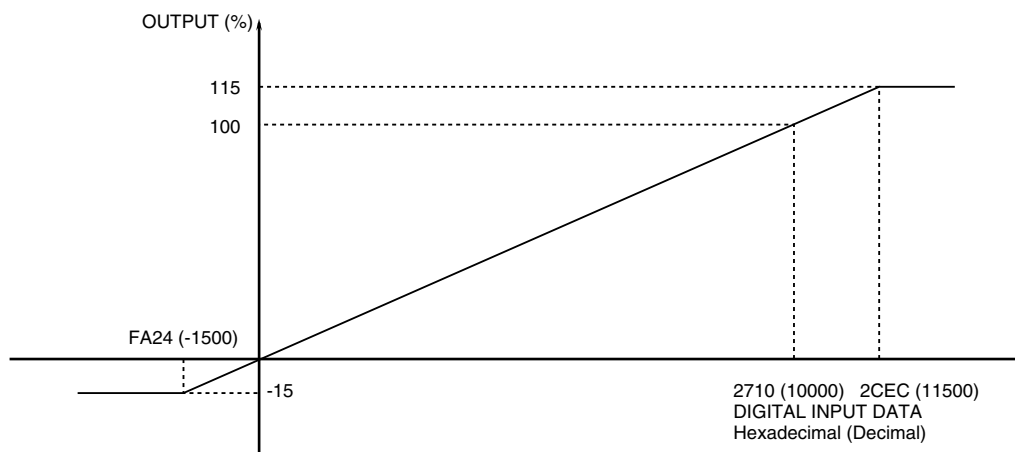

#### (3) OUTPUT IN AN ABNORMALITY

When an abnormality such like CPU error, STOP, time-out occurs at the PLC, the output signal of the M2BC is maintained as HOLD (no clearing output signal, keeping the value just before the abnormality).

When the PLC recovers to normal operation and the M2BC receives new data, the output restarts changing.

## 10. PARAMETERS SETTING BY PLC PROGRAM

### 10.1. GENERAL DESCRIPTION

The ladder diagram below shows a program example assuming that the master station's first I/O number is X/Y20 to 3F. For detailed information, refer to users manuals for the PLC CPU and the Master Unit.

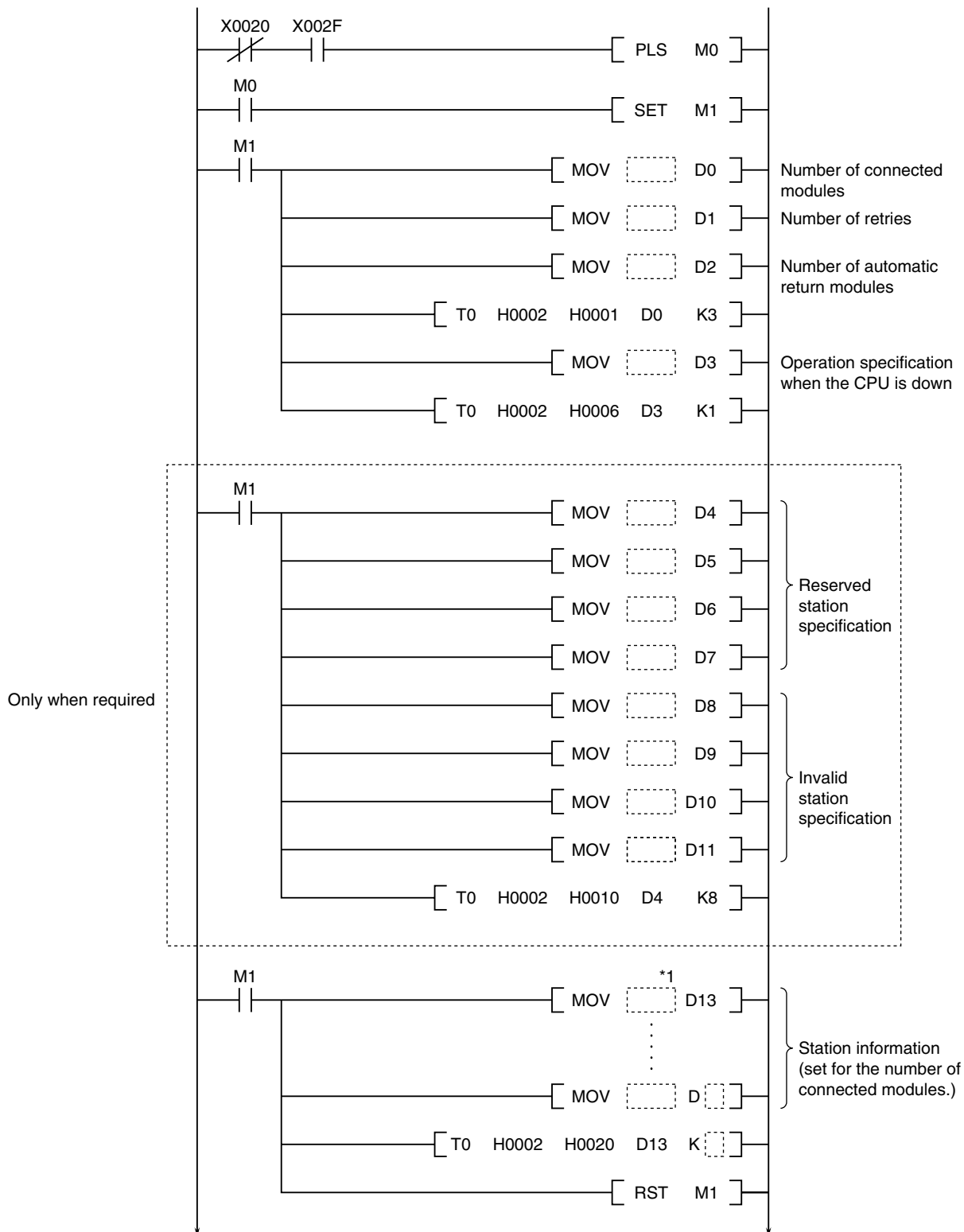

\*1. [Example] 11xx for model M2BC-04  
 12xx for model M2BC-08  
 14xx for model M2BC-16

xx = M2BC Station No.

## 11. TROUBLESHOOTING

Basic troubleshooting methods are explained in this section.

For problems concerning the PLC CPU and Master Unit, consult users manuals for these units.

### 11.1. L ERR. INDICATOR BLINKING

| CHECK   | TROUBLESHOOTING   |
|---|---|
| Have you changed the station No. and/or baud rate settings during normal operation? | Return these settings to the state when the unit operated normally. |

### 11.2. L ERR. INDICATOR ON

| CHECK  | TROUBLESHOOTING     |
|--|---------------------|
| Are the station No. and/or baud rate settings correct? | Set them correctly. |

### 11.3. L RUN INDICATOR OFF

Consult the users manual for the Master Unit.

### 11.4. UNABLE TO READ/WRITE DIGITAL VALUES?

| CHECK  | TROUBLESHOOTING  |
|--|--|
| Is the L RUN indicator OFF?  | Refer to Section "11.3. L RUN INDICATOR OFF".  |
| Is the L ERR. indicator blinking or OFF?   | Consult the users manual for the Master Unit.  |
| Is the RUN indicator on the PLC CPU blinking or OFF?   | Consult the users manual for the CPU.  |
| Is the RUN indicator on the Master Unit OFF?   | Consult the users manual for the Master Unit.  |
| Are the RD/SD indicators on the Master Unit ON?  | Consult the users manual for the Master Unit.  |
| Are the wires for analog I/O properly connected to respective terminals? No wire breakdown?  | Check these wires visually or check conductivity for each pair of wires.   |
| [M2BC-x1]<br>Remove analog input wires and apply test voltage to the terminals (e.g. Use a dry cell). Try to read out digital value. | If the digital value is read out normally, there are possibilities of noise interference via external wires. Check wiring and grounding. |
| [M2BC-x1]<br>Remove analog output wires and connect a tester to the terminals. Try to read out digital value.                        | If the digital value is read out normally, there are possibilities of noise interference via external wires. Check wiring and grounding. |

### 11.5. I/O ZERO & SPAN NEED ADJUSTMENTS?

I/O types and ranges can be field-selectable for certain types of Mini-M series I/O Signal Conditioners, and zero and span adjustments are available for most types. Refer to data sheets for the I/O modules for detailed information.

## 12. LIGHTNING SURGE PROTECTION

We offer a series of lightning surge protectors for protection against induced lightning surges. Please contact us to choose appropriate models.