

<b>CURRENT LOOP SUPPLY</b>	MODEL <b>M3DY</b>
----------------------------	-------------------

**BEFORE USE ....**

Thank you for choosing us. Before use, please check contents of the package you received as outlined below. If you have any problems or questions with the product, please contact our sales office or representatives.

**■ PACKAGE INCLUDES:**

Signal conditioner .....(1)

**■ MODEL NO.**

Confirm Model No. marking on the product to be exactly what you ordered.

**■ INSTRUCTION MANUAL**

This manual describes necessary points of caution when you use this product, including installation, connection and basic maintenance procedures.

**POINTS OF CAUTION**

**■ CONFORMITY WITH EU DIRECTIVES**

- This equipment is suitable for Pollution Degree 2 and Installation Category II (transient voltage 2500V). Reinforced insulation (signal input or output to power input: 300V) and basic insulation (signal input to output: 300V) are maintained. Prior to installation, check that the insulation class of this unit satisfies the system requirements.
- Altitude up to 2000 meters.
- The equipment must be mounted inside a panel.
- The equipment must be installed such that appropriate clearance and creepage distances are maintained to conform to CE requirements. Failure to observe these requirements may invalidate the CE conformance.
- The actual installation environments such as panel configurations, connected devices, connected wires, may affect the protection level of this unit when it is integrated in a panel system. The user may have to review the CE requirements in regard to the whole system and employ additional protective measures to ensure the CE conformity.
- Install lightning surge protectors for those wires connected to remote locations.

**■ POWER INPUT RATING & OPERATIONAL RANGE**

- Locate the power input rating marked on the product and confirm its operational range as indicated below:  
 100 – 240V AC rating: 90 – 264V, 47 – 66 Hz, approx. 3 – 5VA  
 24V DC rating: 24V ±10%, approx. 2W  
 24 – 240V DC rating: 21.6 – 264V, approx. 2W

**■ GENERAL PRECAUTION**

- Before you remove the unit or mount it, turn off the power supply and input signal for safety.

**■ ENVIRONMENT**

- Indoor use.
- When heavy dust or metal particles are present in the air, install the unit inside proper housing with sufficient ventilation.
- Do not install the unit where it is subjected to continuous vibration. Do not subject the unit to physical impact.
- Environmental temperature must be within -20 to +55°C (-4 to 131°F) with relative humidity within 30 to 90% RH in order to ensure adequate life span and operation.
- Be sure that the ventilation slits are not covered with cables, etc.

**■ WIRING**

- Do not install cables close to noise sources (relay drive cable, high frequency line, etc.).
- Do not bind these cables together with those in which noises are present. Do not install them in the same duct.

**■ AND ....**

- The unit is designed to function as soon as power is supplied, however, a warm up for 10 minutes is required for satisfying complete performance described in the data sheet.
- With voltage output, do not leave the output terminals shortcircuited for a long time. The unit is designed to endure it without breakdown, however, it may shorten appropriate life duration.

**COMPONENT IDENTIFICATION**

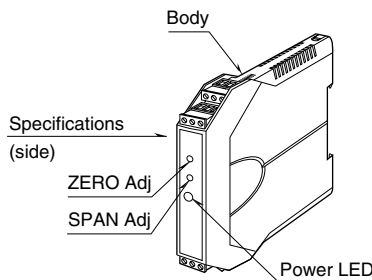

**■ HOW TO SEPARATE THE EURO TYPE CONNECTOR TERMINAL BLOCKS**

When you need to separate the euro type connector terminal blocks from the transmitter body for wiring, insert a minus driver between the euro type connector terminal block and the housing body, pull up the driver and pull out the euro type connector terminal block.

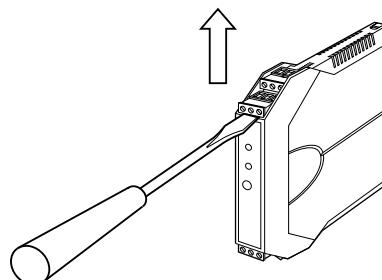

## INSTALLATION

### ■ DIN RAIL MOUNTING

Set the unit so that its DIN rail adaptor is at the bottom. Position the upper hook at the rear side of the unit on the DIN rail and push in the lower. When removing the unit, push down the DIN rail adaptor utilizing a minus screw-driver and pull.

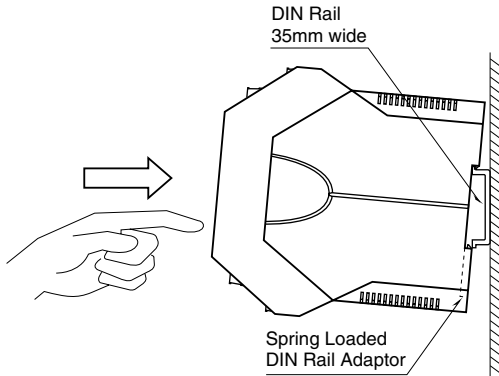

## TERMINAL CONNECTIONS

Connect the unit as in the diagram below or refer to the connection diagram on the side of the unit.

### ■ EXTERNAL DIMENSIONS unit: mm (inch)

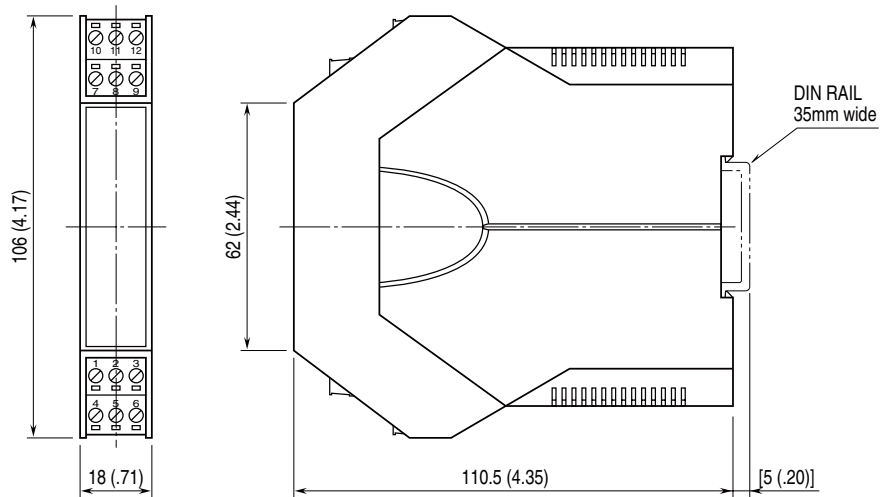

• When mounting, no extra space is needed between units.

### ■ CONNECTION DIAGRAM

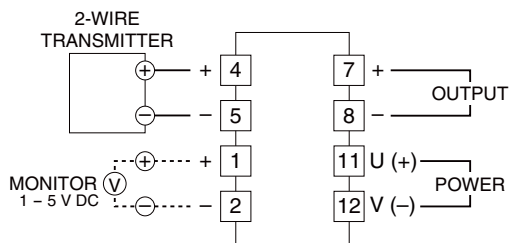

#### ■ When Used as DC Supply

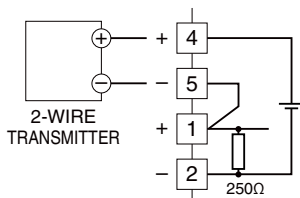

#### ■ When Used as Isolator

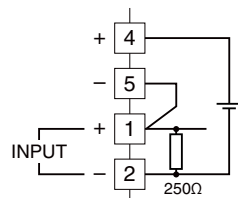

## ■ WIRING INSTRUCTIONS

- Applicable wire size

Solid: 0.2 to 2.5 mm<sup>2</sup> (0.55 to 1.75 dia.)

Stranded: 0.2 to 2.5 mm<sup>2</sup>

Tinning wire ends may cause contact failure and therefore is not recommended.

Ferruled: 0.2 to 1.5 mm<sup>2</sup> (0.55 to 1.35 dia.)

The following Phoenix Contact terminals are recommended:

AI 0,25-8YE 0.2 to 0.25 mm<sup>2</sup>

AI 0,34-8TQ 0.25 to 0.34 mm<sup>2</sup>

AI 0,5-8WH 0.34 to 0.5 mm<sup>2</sup>

AI 0,75-8GY 0.5 to 0.75 mm<sup>2</sup>

AI 1,0-8RD 0.75 to 1.0 mm<sup>2</sup>

AI 1,5-8BK 1.0 to 1.5 mm<sup>2</sup>

- Expose wire conductors by 8 mm (0.31").

Wire exposure

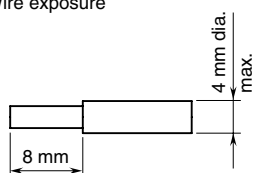

Recommended ferruled wire

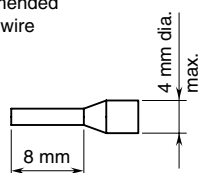

## CHECKING

- 1) Terminal wiring: Check that all cables are correctly connected according to the connection diagram.
- 2) Power input voltage: Check voltage across the terminal 11 – 12 with a multimeter.
- 3) Input: Check that the input signal is within 0 – 100% of the full-scale.
- 4) Output: Check that the load resistance meets the described specifications.

## ADJUSTMENT PROCEDURE

This unit is calibrated at the factory to meet the ordered specifications, therefore you usually do not need any calibration.

For matching the signal to a receiving instrument or in case of regular calibration, adjust the output as explained in the following.

### ■ HOW TO CALIBRATE THE OUTPUT SIGNAL

Use a signal source and measuring instruments of sufficient accuracy level. Turn the power supply on and warm up for more than 10 minutes.

1) ZERO: Apply 0% input and adjust output to 0%.

2) SPAN: Apply 100% input and adjust output to 100%.

3) Check ZERO adjustment again with 0% input.

4) When ZERO value is changed, repeat the above procedure 1) – 3).

## MAINTENANCE

Regular calibration procedure is explained below:

### ■ CALIBRATION

Warm up the unit for at least 10 minutes. Apply 0%, 25%, 50%, 75% and 100% input signal. Check that the output signal for the respective input signal remains within accuracy described in the data sheet. When the output is out of tolerance, recalibrate the unit according to the “ADJUSTMENT PROCEDURE” explained earlier.

## LIGHTNING SURGE PROTECTION

We offer a series of lightning surge protector for protection against induced lightning surges. Please contact us to choose appropriate models.