

CT CONVERTER (clamp-on current sensor)	MODEL M8CTC
--	--------------------

BEFORE USE

Thank you for choosing us. Before use, please check contents of the package you received as outlined below. If you have any problems or questions with the product, please contact our sales office or representatives.

■ PACKAGE INCLUDES:

- Signal conditioner(1)
- Sensor(1)
- Cable (CLSA-08, -12 only)(1)

■ MODEL NO.

Confirm Model No. marking on the product to be exactly what you ordered.

■ INSTRUCTION MANUAL

This manual describes necessary points of caution when you use this product, including installation, connection and basic maintenance procedures.

POINTS OF CAUTION

■ POWER INPUT RATING & OPERATIONAL RANGE

- Locate the power input rating marked on the product and confirm its operational range as indicated below:
 24V DC rating: 24V ±10%, approx. 30mA
 (50mA for current output)

■ GENERAL PRECAUTIONS

- Before you remove the unit or mount it, turn off the power supply and input signal for safety.

■ ENVIRONMENT

- Indoor use.
- When heavy dust or metal particles are present in the air, install the unit inside proper housing with sufficient ventilation.
- Do not install the unit where it is subjected to continuous vibration. Do not subject the unit to physical impact.
- Environmental temperature must be within 0 to 55°C (32 to 131°F) with relative humidity within 30 to 95% RH in order to ensure adequate life span and operation.
- Be sure that the ventilation slits are not covered with cables, etc.

■ WIRING

- Do not install cables close to noise sources (relay drive cable, high frequency line, etc.).
- Do not bind these cables together with those in which noises are present. Do not install them in the same duct.

■ AND

- The unit is designed to function as soon as power is supplied, however, a warm up for 10 minutes is required for satisfying complete performance described in the data sheet.

COMPONENT IDENTIFICATION

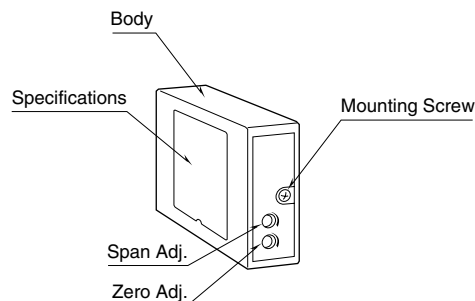

INSTALLATION

Use Installation Base (model: M8BSx).

■ CLAMP-ON CURRENT SENSOR

Secure the sensor to the cable e.g. using tie wraps. Over-voltage clamp element is incorporated for safety in open circuit.

TERMINAL CONNECTIONS

Connect the unit as in the diagram below.

EXTERNAL DIMENSIONS unit: mm (inch)

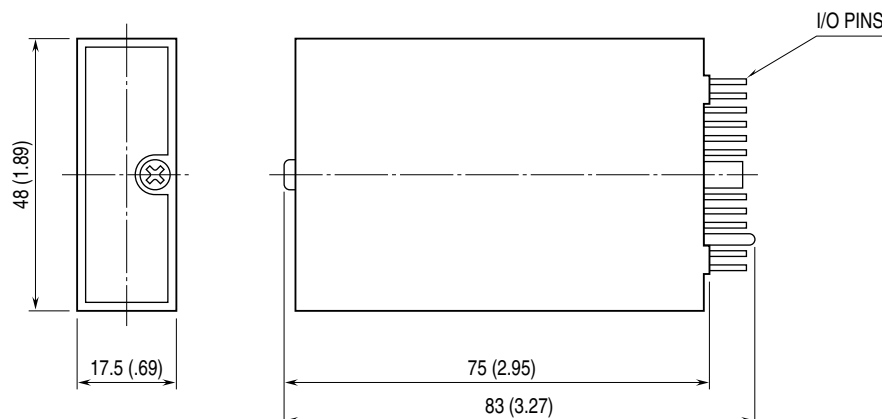

CONNECTION DIAGRAM

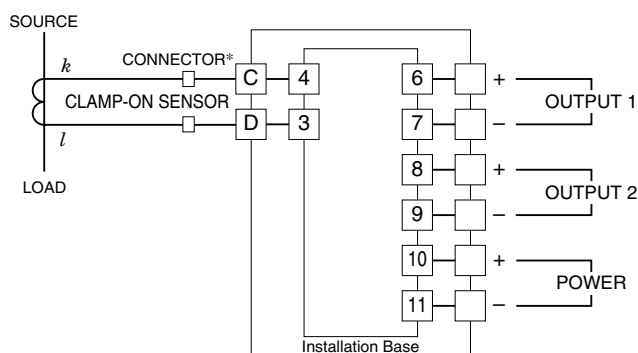

*Connector provided only for the CLSA-08 and CLSA-12.

CHECKING

- 1) Terminal wiring: Check that all cables are correctly connected according to the connection diagram.
- 2) Power input: Check the power input voltage.
- 3) Input: Check that the input signal is within 0 – 100% of the full-scale.
- 4) Output: Check that the load resistance meets the described specifications.

ADJUSTMENT PROCEDURE

This unit is calibrated at the factory to meet the ordered specifications, therefore you usually do not need any calibration.

For matching the signal to a receiving instrument or in case of regular calibration, adjust the output as explained in the following.

HOW TO CALIBRATE THE OUTPUT SIGNAL

Use a signal source and measuring instruments of sufficient accuracy level. Turn the power supply on and warm up for more than 10 minutes.

(Output 1 and Output 2 are linked.)

- 1) ZERO: Apply 0% input and adjust output to 0%.
- 2) SPAN: Apply 100% input and adjust output to 100%.
- 3) Check ZERO adjustment again with 0% input.
- 4) When ZERO value is changed, repeat the above procedure 1) – 3).

MAINTENANCE

Regular calibration procedure is explained below:

CALIBRATION

Warm up the unit for at least 10 minutes. Apply 0%, 25%, 50%, 75% and 100% input signal. Check that the output signal for the respective input signal remains within accuracy described in the data sheet. When the output is out of tolerance, recalibrate the unit according to the “ADJUSTMENT PROCEDURE” explained earlier.

LIGHTNING SURGE PROTECTION

We offer a series of lightning surge protector for protection against induced lightning surges. Please contact us to choose appropriate models.

CLAMP-ON CURRENT SENSOR

The clamp-on current sensor is included in the product package.

■ CLAMP-ON CURRENT SENSOR (leadwire type CLSA)

- 0 – 10A through 0 – 75A Use

Sensor model No.: CLSA-08

Sensor cable model No.: CLSA-08C-30

Applicable cable diameter: Max. 10.0

Sensor leadwire: AWG 22

Weight: 45 g (1.6 oz)

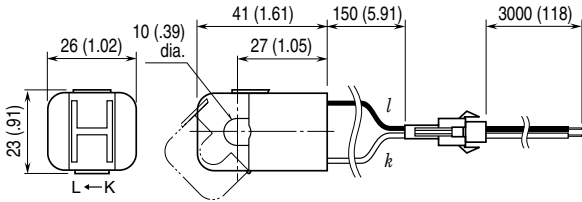

- 0 – 100A Use

Sensor model No.: CLSA-12

Sensor cable model No.: CLSA-08C-30

Applicable cable diameter: Max. 16.0

Sensor leadwire: AWG 22

Weight: 70 g (2.5 oz)

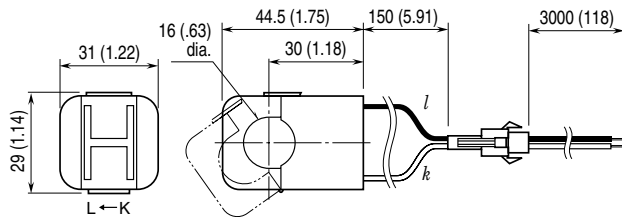

- 0 – 125A through 0 – 300A Use

Sensor model No.: CLSA-30

Applicable cable diameter: Max. 24.0

Sensor leadwire: AWG 18, 200 mm

Weight: 200 g (7.1 oz)

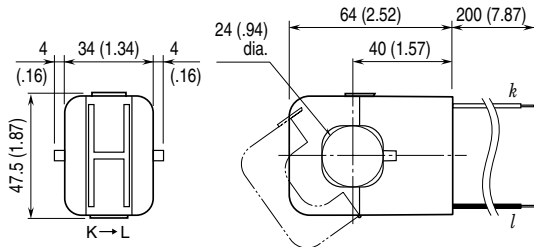

- 0 – 350A through 0 – 500A Use

Sensor model No.: CLSA-50

Applicable cable diameter: Max. 36.0

Sensor leadwire: AWG 18, 200 mm

Weight: 300 g (10.6 oz)

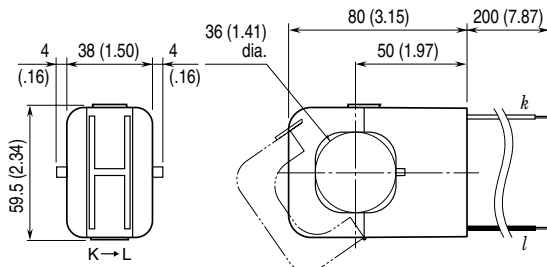

■ CLAMP-ON CURRENT SENSOR (screw terminal type CLSB)

Connection: M3 screw terminal (torque 0.5 N·m)

Screw terminal: Nickel-plated steel

Output wiring: Use AWG 22 or thicker wires for the output.

Twist the paired wires, extendable up to 30 meters.

- 0 – 10A through 0 – 50A Use

Sensor model No.: CLSB-05

Applicable cable diameter: Max. 10.0

Weight: 45 g (1.6 oz)

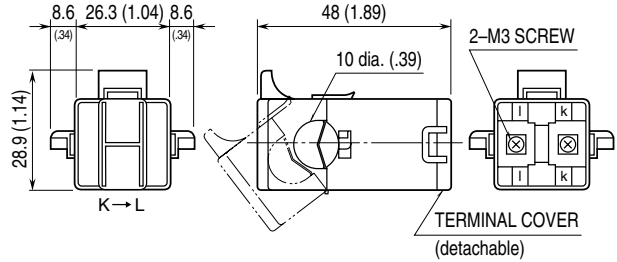

- 0 – 60A through 0 – 100A Use

Sensor model No.: CLSB-10

Applicable cable diameter: Max. 16.0

Weight: 80 g (2.8 oz)

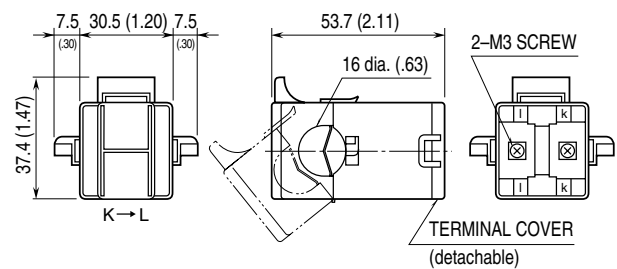

- 0 – 125A through 0 – 200A Use

Sensor model No.: CLSB-20

Applicable cable diameter: Max. 24.0

Weight: 200 g (7.1 oz)

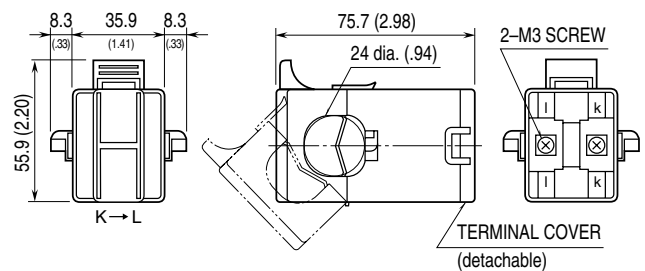

• 0 – 225A through 0 – 400A Use

Sensor model No.: CLSB-40

Applicable cable diameter: Max. 35.0

Weight: 300 g (10.6 oz)

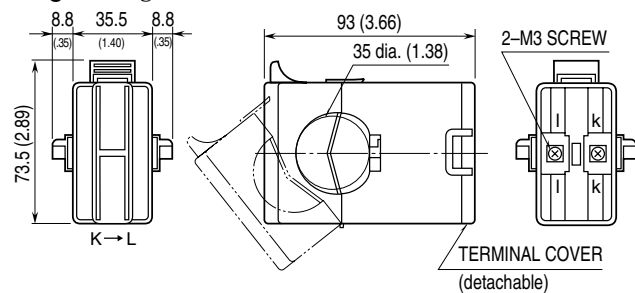

• 0 – 500A through 0 – 600A Use

Sensor model No.: CLSB-60

Applicable cable diameter: Max. 35.0

Weight: 360 g (12.7 oz)

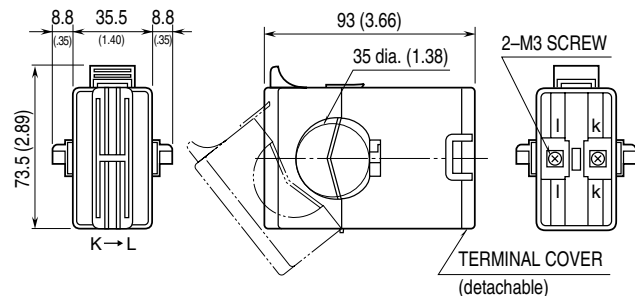

Note 1: The output values may vary depending on the accuracy of engagement at the clamp connection.

Note 2: The sensor is detachable up to 100 times (approx.).

Note 3: The sensor's mechanical construction may cause it to generate resonance sound. However, it does not affect the performance of the sensor.