

PULSE ISOLATOR (built-in excitation)	MODEL	PPD
---	-------	------------

BEFORE USE

Thank you for choosing us. Before use, please check contents of the package you received as outlined below. If you have any problems or questions with the product, please contact our sales office or representatives.

■ PACKAGE INCLUDES:

Signal conditioner (body + base socket).....(1)

■ MODEL NO.

Confirm Model No. marking on the product to be exactly what you ordered.

■ INSTRUCTION MANUAL

This manual describes necessary points of caution when you use this product, including installation, connection, hardware setting and basic maintenance procedures. This unit is factory adjusted and calibrated according to the Ordering Information included in the product package. If you don't need to change the pre-adjusted setting, you can skip the sections on hardware setting and calibration in this manual.

POINTS OF CAUTION

■ POWER INPUT RATING & OPERATIONAL RANGE

- Locate the power input rating marked on the product and confirm its operational range as indicated below:
 85 – 132V AC rating: 85 – 132V, 47 – 66 Hz, approx. 6VA
 12V, 24V and 48V DC ratings: Rating ±10%, approx. 6W
 110V DC rating: 85 – 150V DC, approx. 6W

■ GENERAL PRECAUTIONS

- Before you remove the unit from its base socket or mount it, turn off the power supply and input signal for safety.

■ ENVIRONMENT

- Indoor use.
- When heavy dust or metal particles are present in the air, install the unit inside proper housing with sufficient ventilation.
- Do not install the unit where it is subjected to continuous vibration. Do not subject the unit to physical impact.
- Environmental temperature must be within -5 to +60°C (23 to 140°F) with relative humidity within 30 to 90% RH in order to ensure adequate life span and operation.

■ WIRING

- Do not install cables close to noise sources (relay drive cable, high frequency line, etc.).
- Do not bind these cables together with those in which noises are present. Do not install them in the same duct.

■ AND

- The unit is designed to function as soon as power is supplied, however, a warm up for 10 minutes is required for satisfying complete performance described in the data sheet.

COMPONENT IDENTIFICATION

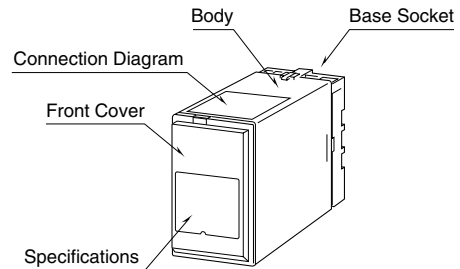

■ HOW TO OPEN THE FRONT COVER:

Hang your finger on the hook at the top of the front cover and pull.

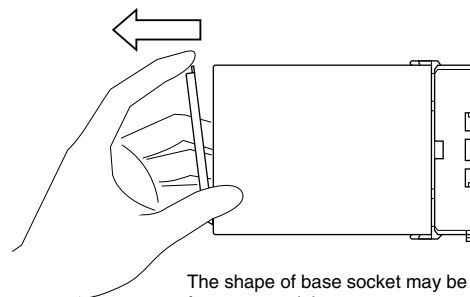

The shape of base socket may be different for some models.

■ FRONT PANEL CONFIGURATION

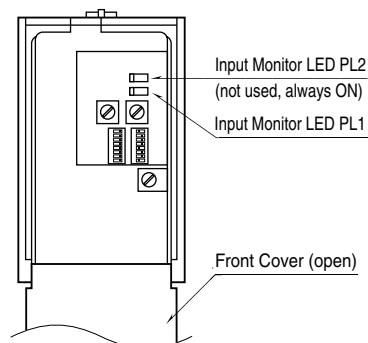

INSTALLATION

Detach the yellow clamps located at the top and bottom of the unit for separate the body from the base socket.

■ DIN RAIL MOUNTING

Set the base socket so that its DIN rail adaptor is at the bottom. Hang the upper hook at the rear side of base socket on the DIN rail and push in the lower. When removing the socket, push down the DIN rail adaptor utilizing a minus screwdriver and pull.

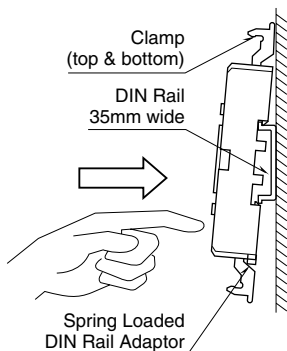

■ WALL MOUNTING

Refer to “EXTERNAL DIMENSIONS.”

Shape and size of the base socket are slightly different with various socket types.

TERMINAL CONNECTIONS

Connect the unit as in the diagram below or refer to the connection diagram on the top of the unit.

■ EXTERNAL DIMENSIONS unit: mm (inch)

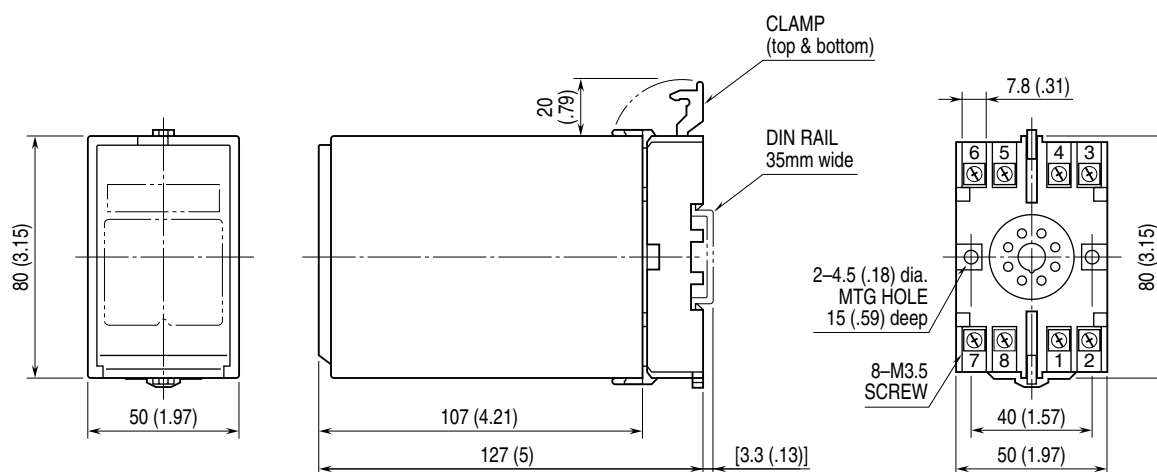

• When mounting, no extra space is needed between units.

■ CONNECTION DIAGRAM

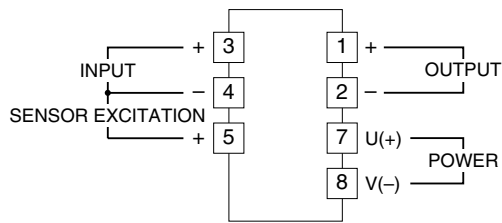

Input Connection Examples

■ Dry Contact

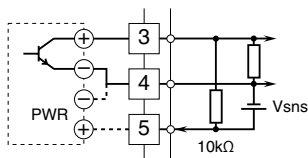

■ Voltage Pulse

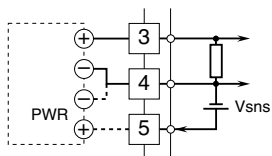

■ 2-Wire Current Pulse

• Built-in Excitation

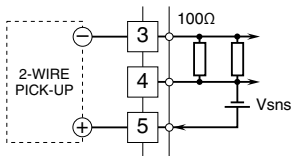

• External DC Supply

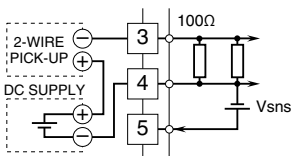

Output Connection Examples

■ Open Collector

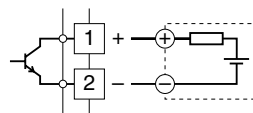

■ Voltage Pulse

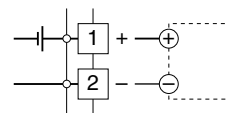

■ Power Photo MOSFET Relay

• AC Powered

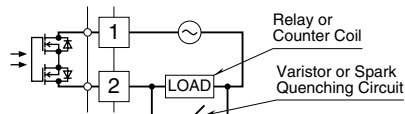



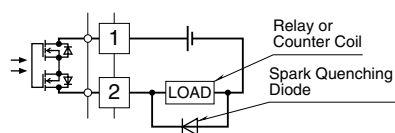





• DC Powered



FUNCTION & FEATURES

- Galvanically isolating pulse rate signals.
- Pulse logic can be converted.
- For one-shot output, a pulse rise or drop can be selected for synchronization.
- Pulse width for one-shot output: 30 μsec. – 300 msec.
- Accepting a wide variety of input: 0.5 – 50V at the input terminals
- Built-in sensor excitation: 5V @ 120mA, 12V @ 60mA, 24V @ 25mA

I/O PULSE LOGIC

OUTPUT WAVEFORM		INPUT WAVEFORM	VOLTAGE PULSE or 2-WIRE CURRENT PULSE	DRY CONTACT
			H L	OFF ON
VOLTAGE PULSE	Non Inverted	No pulse width conversion	H L	H L
		One-shot, detecting input pulse rise 	H L	H L
		One-shot, detecting input pulse drop 	H L	H L
	Inverted	No pulse width conversion	H L	H L
		One-shot, detecting input pulse rise 	H L	H L
		One-shot, detecting input pulse drop 	H L	H L
OPEN COLLECTOR or POWER PHOTO MOSFET RELAY	Non Inverted	No pulse width conversion	OFF ON	OFF ON
		One-shot, detecting input pulse rise 	OFF ON	OFF ON
		One-shot, detecting input pulse drop 	OFF ON	OFF ON
	Inverted	No pulse width conversion	OFF ON	OFF ON
		One-shot, detecting input pulse rise 	OFF ON	OFF ON
		One-shot, detecting input pulse drop 	OFF ON	OFF ON

The pulse width in one-shot means the bold lined section of a pulse waveform.

HARDWARE SETTING & CALIBRATION

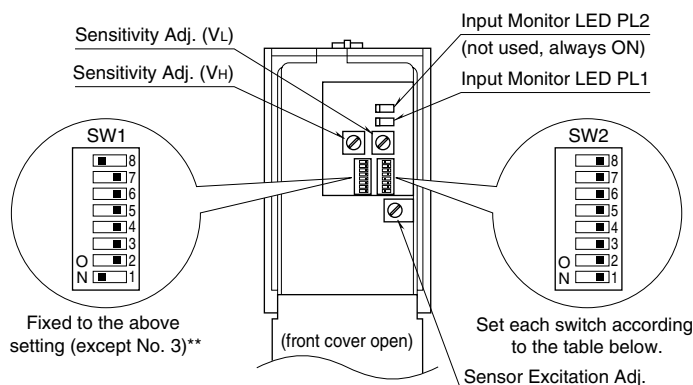

SW2 FUNCTIONS

SWITCH NO.	SW FUNCTION	INPUT CODE				
		A	B	C	D	H
SW2 - 1	ON with dry contact input (model suffix: A)	ON	OFF	OFF	OFF	OFF
2	ON with 2-wire current pulse input (model suffix: H)	OFF	OFF	OFF	OFF	ON
3	Adjustable range of sensitivity level for V_H (ON: 0 – 10 V, OFF: 0 – 5 V) Refer to the section “SENSITIVITY ADJUSTMENT”. SW1-3 is used for V_L adjustment.	ON or OFF (required level)		OFF	OFF	OFF
4	Always ON	ON or OFF according to the adjustment				
5	Noise filter Type 1 (ON: with, OFF: without)	ON or OFF according to the noise level. Refer to the tables below for the max. frequency which can pass through the filter.				
6	Noise filter Type 2 (ON: with, OFF: without)					
7	Attenuator for input signal (ON: with, OFF: without) Input voltage is attenuated to half the original amplitude with this switch ON. (one-third for the model number suffix code A.)	OFF*	OFF*	OFF	OFF*	OFF
8	Input pulse sensing method (ON: DC coupled, OFF: AC coupled) Turn this switch off with a 10 V or greater offset.	ON				

*Set to ON with excitation voltage ≥ 24 V.

**SW1-3 is for V_L adjustment, SW2-3 for V_H .

INPUT FILTER

The tables below show the maximum frequency which can pass through the filter when the sensitivity level is set to 2 V. The frequency may change according to the sensitivity level.

After turning the filter ON, check that the PL1 blinks according to the input signal. If it does not, readjust the sensitivity according to the instructions in the following section.

• Noise Filter Type 1 (SW2-5 = ON)

DC Coupling (SW2-8 = ON)		AC Coupling (SW2-8 = OFF)	
V p-p (V)	MAX. FREQ. (Hz)	V p-p (V)	MAX. FREQ. (Hz)
5	69	5	22
12	35	12	65
24	89	24	112

• Noise Filter Type 2 (SW2-6 = ON)

DC Coupling (SW2-8 = ON)		AC Coupling (SW2-8 = OFF)	
V p-p (V)	MAX. FREQ. (Hz)	V p-p (V)	MAX. FREQ. (Hz)
5	1220	5	256
12	329	12	664
24	851	24	1090

SENSITIVITY ADJUSTMENT

You can change the detection level with the sensitivity adj. located behind the front cover. The V_H determines the pulse rise and the V_L determines the pulse fall. See the Ordering Information Sheet included in the package for the factory settings.

How to Change the Sensitivity

A voltmeter of class 0.5 or better accuracy with pointed probes is required.

- 1) Connect the negative probe of voltmeter to the terminal 4 of base socket. See the figure to the right.
- 2) If you need a noise filter, turn on the SW2-5 or SW2-6.
- 3) Connect the positive probe to the test hole No. 2 and turn the V_H potentiometer until the meter shows desired value.*
- 4) Connect the positive probe to the test hole No. 3 and turn the V_L potentiometer until the meter shows desired value.*
- 5) Apply input signal and check that input monitor LED (PL1) blinks according to the input signal.**

* For the V_H (V_L) sensitivity level less than 5 V, turn off the SW2-3 (SW1-3). For less than 10 V, turn on the SW2-3 (SW1-3). The voltage values approx. half the amplitude are recommended for normal use.

You had better have a reasonable span between V_H and V_L in order to prevent noise interference.

** If the LED does not blink correctly, the sensitivity level may be out of the pulse amplitude. Check the offset, amplitude, etc. and go through the adjustment procedure again.

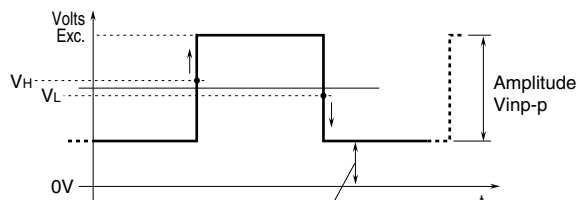
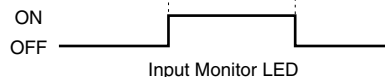
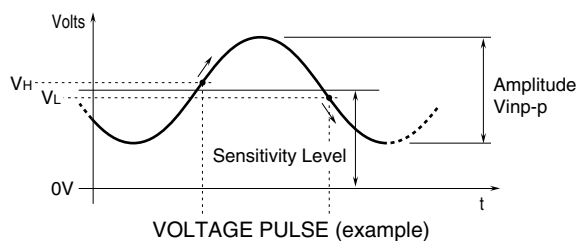
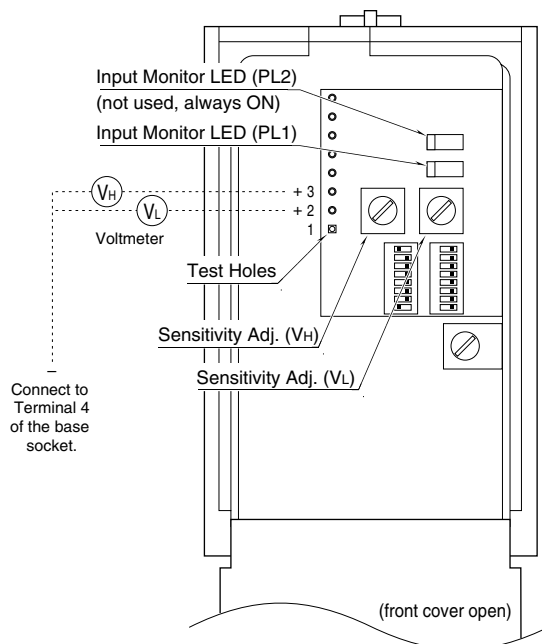

The voltage which remains across the terminals with contact ON

SENSOR EXCITATION ADJUSTMENT

You can change the sensor excitation voltage with the sensor excitation adj. located behind the front cover. If you need to change it, check that the required current is within the specification.

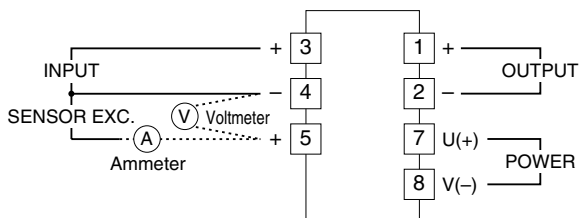

How to Change the Excitation

A voltmeter and ammeter of class 0.5 or better accuracy are required.

- 1) Connect the voltmeter across the terminal 5 – 4.
- 2) Connect the ammeter to terminal 5.
- 3) Turn the potentiometer until the meter shows the desired value. Check that the current value indicated on the ammeter is within the allowable limit. If the value is greater than the limit, lower the voltage value or connect a separate power source. Otherwise, the transmitter may fail.

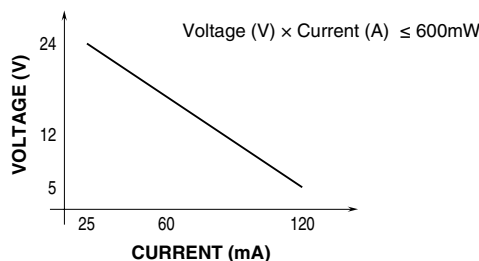

MAINTENANCE

Regular calibration procedure is explained below:

■ TROUBLESHOOTING

Refer to the flow chart below.

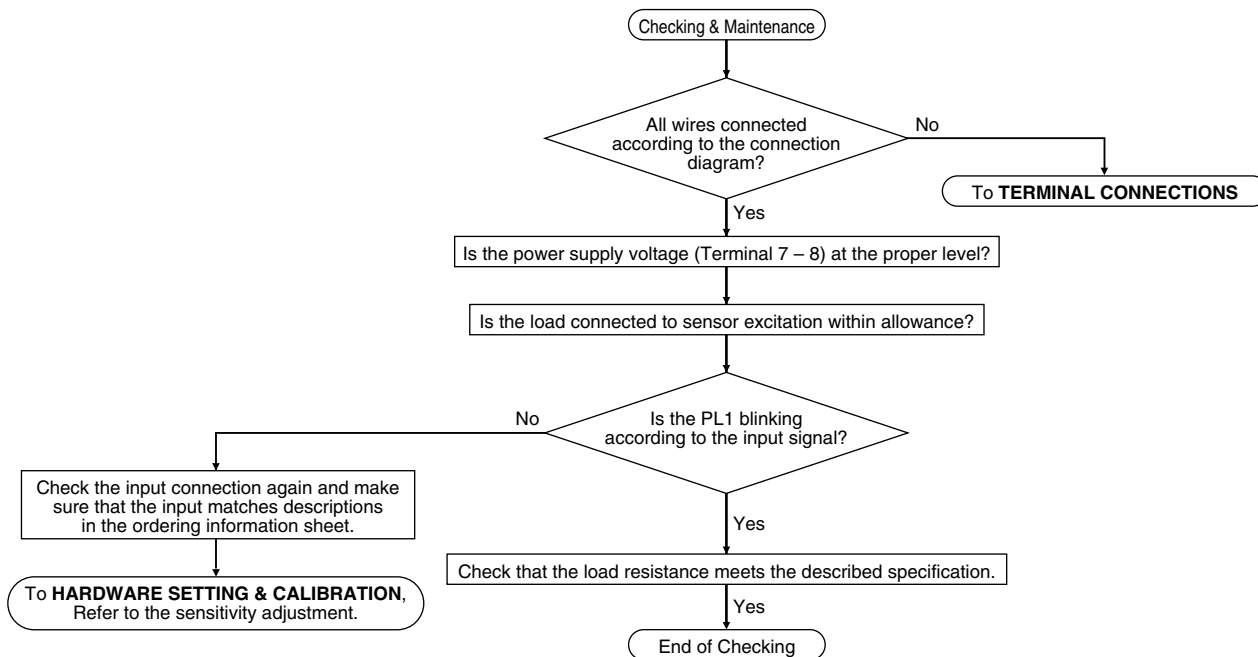

LIGHTNING SURGE PROTECTION

We offer a series of lightning surge protector for protection against induced lightning surges. Please contact us to choose appropriate models.