

**DISCRETE OUTPUT MODULE**  
(relay contact output, 8 points)MODEL **R3-DC8****BEFORE USE ....**

Thank you for choosing us. Before use, please check contents of the package you received as outlined below.

If you have any problems or questions with the product, please contact our sales office or representatives.

**■ PACKAGE INCLUDES:**

Discrete output module.....(1)

**■ MODEL NO.**

Confirm Model No. marking on the product to be exactly what you ordered.

**■ INSTRUCTION MANUAL**

This manual describes necessary points of caution when you use this product, including installation, connection and basic maintenance procedures.

**POINTS OF CAUTION****■ CONFORMITY WITH EU DIRECTIVES**

- The equipment must be mounted inside the instrument panel of a metal enclosure.
- The actual installation environments such as panel configurations, connected devices, connected wires, may affect the protection level of this unit when it is integrated in a panel system. The user may have to review the CE requirements in regard to the whole system and employ additional protective measures to ensure the CE conformity.

**■ HOT SWAPPABLE MODULES**

- Replacing the module does not affect other modules on the same base. Thus, the module can be replaced while the power is ON. However, replacing multiple modules at once may greatly change live voltage levels. We highly recommend to replace them one by one.

**■ GENERAL PRECAUTIONS**

- DO NOT set the switches on the module while the power is supplied. The switches are used only for maintenance without the power.

**■ ENVIRONMENT**

- Indoor use.
- When heavy dust or metal particles are present in the air, install the unit inside proper housing with sufficient ventilation.
- Do not install the unit where it is subjected to continuous vibration. Do not subject the unit to physical impact.
- Environmental temperature must be within -10 to +55°C (14 to 131°F) with relative humidity within 30 to 90% RH in order to ensure adequate life span and operation.

**■ WIRING**

- Do not install cables close to noise sources (relay drive cable, high frequency line, etc.).
- Do not bind these cables together with those in which noises are present. Do not install them in the same duct.

**■ AND ....**

- The unit is designed to function as soon as power is supplied, however, a warm up for 10 minutes is required for satisfying complete performance described in the data sheet.

**INSTALLATION**

Use the Installation Base (model: R3-BSx) .

## COMPONENT IDENTIFICATION

### FRONT VIEW

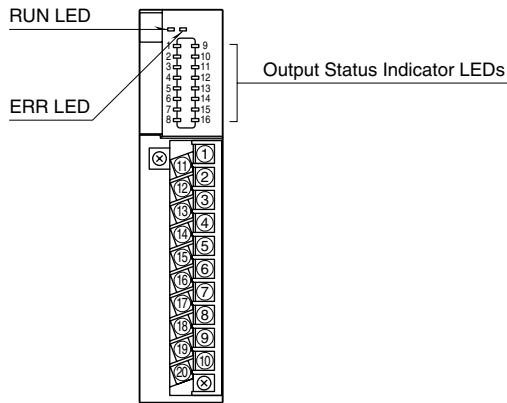

### SIDE VIEW

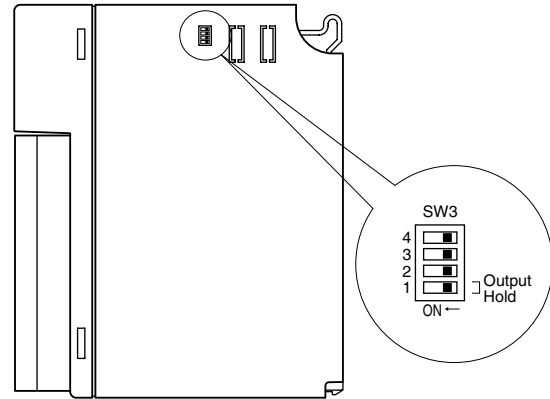

### STATUS INDICATOR LED

**RUN indicator:** Bi-color (red/green) LED;  
 Red when the bus A operates normally;  
 Green when the bus B operates normally;  
 Amber when both buses operate normally.

**ERR indicator:** Green LED turns on in normal operating conditions.

### Output status indicator:

- 1 to 8: Red LED; turns on with the output ON.
- 9 to 16: Unused.

### SIDE DIP SW

#### • Output Hold: SW3-1

| SW    | OUTPUT HOLD |     |
|-------|-------------|-----|
|       | HOLD (*)    | OFF |
| SW3-1 | OFF         | ON  |

(\*) Factory setting

Note: Be sure to set unused SW3-2 through 3-4 to OFF.

## TERMINAL CONNECTIONS

Connect the unit as in the diagram below.

### EXTERNAL DIMENSIONS unit: mm (inch)

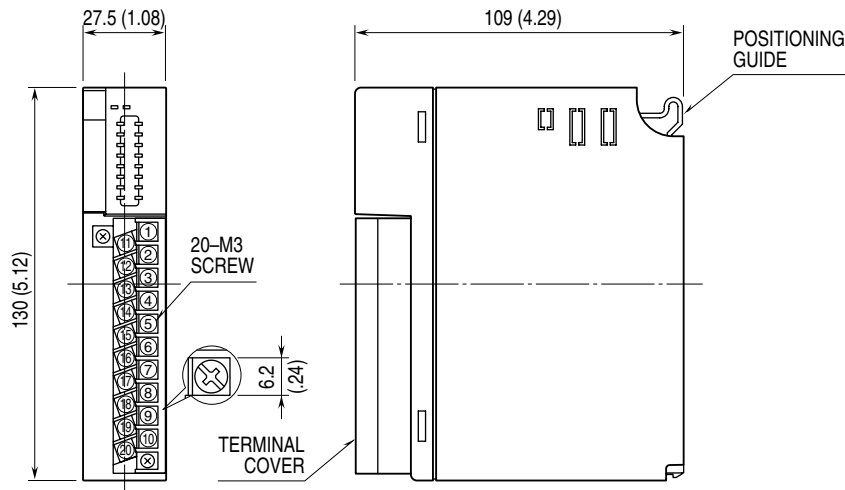

■ CONNECTION DIAGRAM

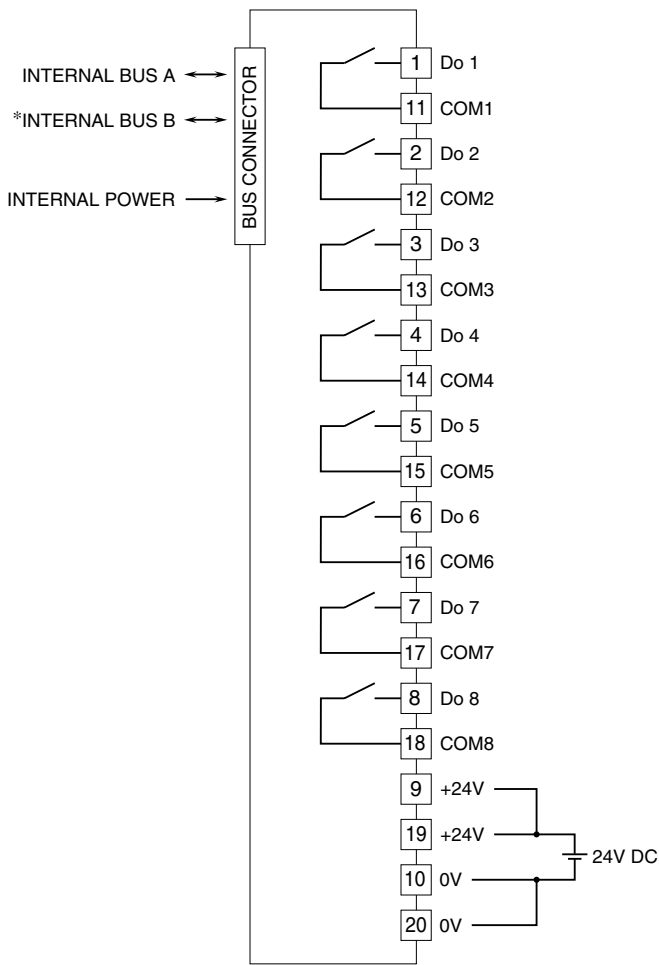

\* For dual redundant communication.

■ Output Connection Examples  
1 point 1 common

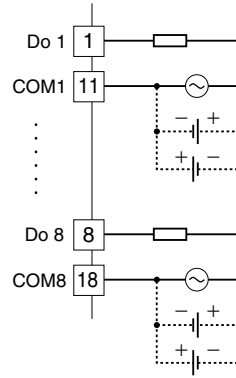

## WIRING INSTRUCTIONS

### ■ SCREW TERMINAL

Torque: 0.5 N·m

### ■ SOLDERLESS TERMINAL

Refer to the drawing below for recommended ring tongue terminal size. Spade tongue type is also applicable. Solderless terminals with insulation sleeve do not fit.

Applicable wire size: 0.3 – 0.5 mm<sup>2</sup>

Recommended manufacturer: Japan Solderless Terminal MFG. Co., Ltd., Nichifu Co., Ltd.

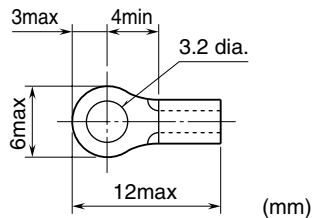

## DATA ASSIGNMENT

### ■ Do

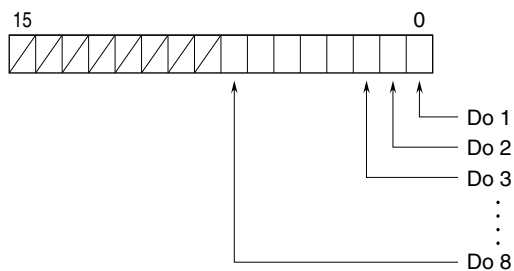

## FUNCTIONS

### ■ OUTPUT HOLD or OUTPUT OFF

In normal conditions, the module outputs the signal from the preferred bus A.

When an error is detected, the output is switched to the data from the bus B.

#### • Output Hold

If both are in error, the module holds the signal and stands by until one of the communications recovers.

#### • Output OFF

If both are in error, the module outputs OFF signals and stands by until one of the communications recovers.

At the startup, it outputs OFF until the communication is established and normal data is received.