

CC-Link INTERFACE MODULE
(CC-Link Ver.1.10/Ver.2.00)

MODEL **R3-GC1**

BEFORE USE

Thank you for choosing us. Before use, please check contents of the package you received as outlined below. If you have any problems or questions with the product, please contact our sales office or representatives.

■ PACKAGE INCLUDES:

- Network interface module(1)
- Terminating resistor (110 Ω, 0.5 W)(1)

■ MODEL NO.

Confirm Model No. marking on the product to be exactly what you ordered.

■ INSTRUCTION MANUAL

This manual describes necessary points of caution when you use this product, including installation, connection and basic maintenance procedures.

POINTS OF CAUTION

■ CONFORMITY WITH EU DIRECTIVES

- The equipment must be mounted inside the instrument panel of a metal enclosure.
- The actual installation environments such as panel configurations, connected devices, connected wires, may affect the protection level of this unit when it is integrated in a panel system. The user may have to review the CE requirements in regard to the whole system and employ additional protective measures to ensure the CE conformity.

■ HOT SWAPPABLE MODULES

- The module can be replaced while the power is ON. Be sure to replace it when the module is not communicating with a host, as it may affect the system. Replacing multiple modules at once may greatly change line voltage levels. We highly recommend to replace them one by one.

■ GENERAL PRECAUTIONS

- DO NOT set the switches on the module while the power is supplied. The switches are used only for maintenance without the power.

■ ENVIRONMENT

- Indoor use.
- When heavy dust or metal particles are present in the air, install the unit inside proper housing with sufficient ventilation.
- Do not install the unit where it is subjected to continuous vibration. Do not subject the unit to physical impact.
- Environmental temperature must be within -10 to +55°C (14 to 131°F) with relative humidity within 30 to 90% RH in order to ensure adequate life span and operation.

■ WIRING

- Do not install cables close to noise sources (relay drive cable, high frequency line, etc.).
- Do not bind these cables together with those in which noises are present. Do not install them in the same duct.

■ AND

- The unit is designed to function as soon as power is supplied, however, a warm up for 10 minutes is required for satisfying complete performance described in the data sheet.

INSTALLATION

Use the Installation Base Model R3-BS, or Model R3-BSW for free I/O address capability.

Before mounting the Network Interface Module onto the base, be sure to configure the module as explained below.

■ CC-Link VERSION & EXPANDED CYCLIC

Set CC-Link's version and expanded cyclic by using the side DIP switch SW3.

The setting determines the number of slots which the module is assigned to.

See "TRANSMISSION DATA DESCRIPTIONS".

■ STATION NO. & BAUD RATE

See "COMPONENT IDENTIFICATION".

■ NETWORK SLOTS ON THE BASE

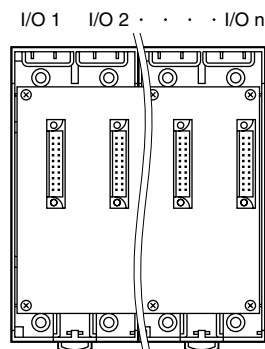

With Model R3-BS base, mount the I/O Modules from the left end (I/O 1) to the right in order that the Network Module assigns data areas from I/O 1.

Network Module(s) and Power Module are mounted basically at the right end though technically they could be mounted in any position.

With Model R3-BSW base, there is no limitation in mounting positions as I/O address can be assigned freely to each module using rotary switches equipped on the base.

R3-GC1 occupies up to 16 slots. Be careful not to use the slot numbers occupied by this unit for real I/O modules to be mounted on the same base. Also, when mounting this unit, be careful about the slot position and the number of slots to be occupied so that any of the slot numbers will not be greater than 16. The Network module cannot read data for an I/O module assigned to slot No. 17 or later.

COMPONENT IDENTIFICATION

FRONT VIEW

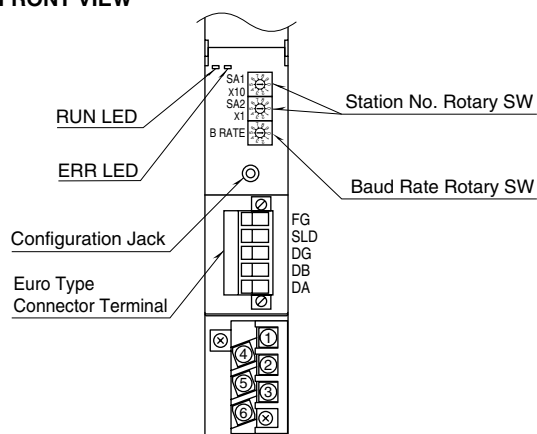

SIDE VIEW

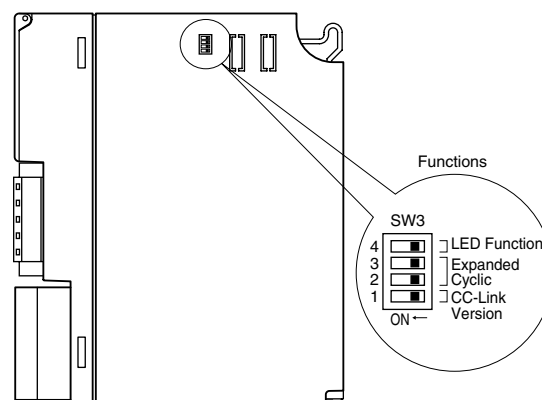

ROTARY SW

Baud Rate: B RATE

SW POSITION	BAUD RATE
0	156 kbps
1	625 kbps
2	2.5 Mbps
3	5 Mbps
4	10 Mbps
Other	Unused

Station No.: SA1, SA2

Station Address is set in decimal.
(Setpoint adjustment: 01 – 64)

SIDE DIP SW

(*) Factory setting.

CC-Link Version: SW3-1

SW	CC-LINK VERSION	
	1.10	2.00
SW3-1	OFF (*)	ON

Expanded Cyclic: SW3-2, 3-3

When SW3-1 is set to OFF, CC-Link Ver.1.10 is available, expanded cyclic setting is not available.

SW	EXPANDED CYCLIC		
	2	4	8
SW3-2	OFF (*)	ON	OFF
SW3-3	OFF (*)	OFF	ON

LED Function: SW3-4

Functions assigned to the front RUN and ERR LEDs can be selected.

SW3-4	LED FUNCTION	
	RUN	ERR
OFF (*)	Green turns ON when CC-Link communication is normal and fieldbus communication on the R3 Network module side is also normal	Green turns ON/blinks in communication errors (OFF with wire breakdown; Green blinks with setting errors)
ON	Red turns ON when receiving data	Red turns ON when transmitting data

TERMINAL CONNECTIONS

Connect the unit as in the diagram below.

EXTERNAL DIMENSIONS unit: mm (inch)

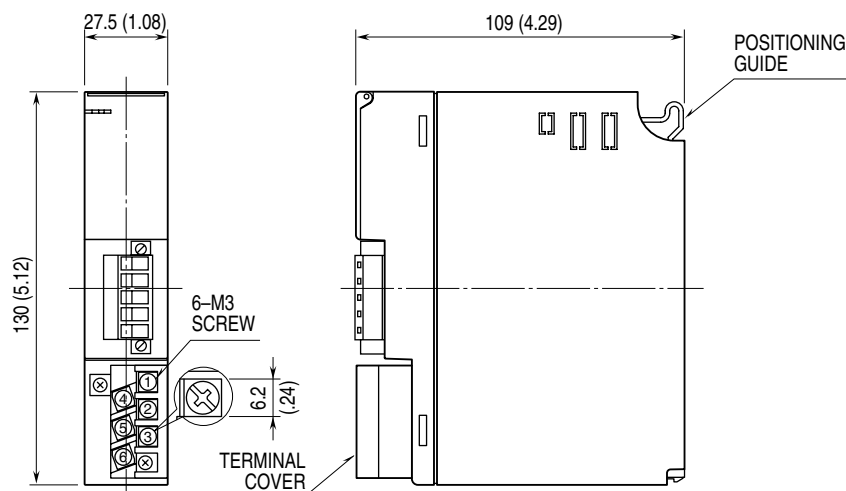

CONNECTION DIAGRAM

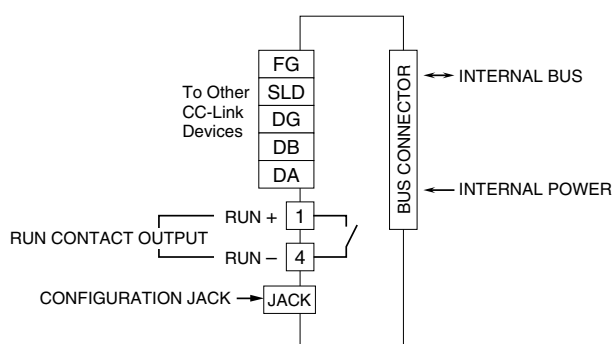

WIRING INSTRUCTIONS

M3 SCREW TERMINAL (RUN contact output)

Torque: 0.5 N·m

SOLDERLESS TERMINAL unit: mm (inch)

Refer to the drawing below for recommended ring tongue terminal size. Spade tongue type is also applicable. Solderless terminals with insulation sleeve do not fit.

Applicable wire size: 0.75 – 1.25 mm²

Recommended manufacturer: Japan Solderless Terminal MFG. Co.,Ltd., Nichifu Co.,Ltd.

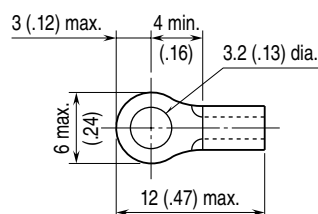

EURO TYPE CONNECTOR TERMINAL (CC-Link)

Applicable wire size: 0.2 – 2.5 mm²

Stripped length: 7 mm

COMMUNICATION CABLE CONNECTIONS

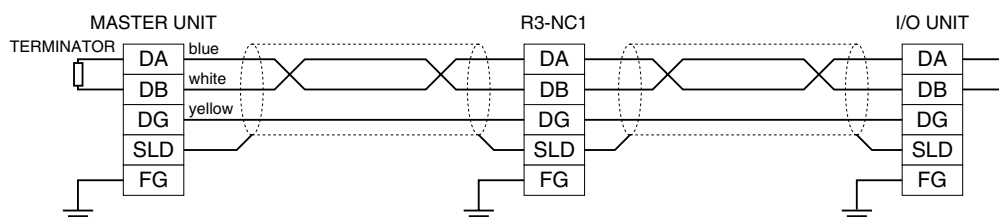

TRANSMISSION DATA DESCRIPTIONS

Use the DIP SW located at the side of the module to specify expanded cyclic setting. 16 words input and 16 words output make 1 cyclic. Max. 8 cyclic (128 words input, 128 words output) transmission is available. 1 cyclic is equivalent to 1 I/O module (analog input 16 points, analog output 16 points). Max. 8 I/O modules can be assigned to 8 slots.

Note: Do not mount any modules in the slots which are occupied by virtual modules. If a real I/O module is mounted in the slot, an internal bus error occurs and the ERR LED turns on. Max. 16 real I/O modules and virtual modules are available. The interface module can not read the data for more than 16 modules.

■ WHEN R3-GC1 IS MOUNTED ON SLOT NO. 2 (4 CYCLIC)

Real I/O modules are mounted on Slots No. 1 and 2, however, the network module (R3-NE1) recognizes that each of Slots No. 1 to 5 is occupied. That is, R3-NE1 recognizes R3-SV4 mounted on Slot No.1 as it is and recognizes R3-GC1 mounted on Slot No.2 as divided into four modules and occupying Slots No. 2 to 5.

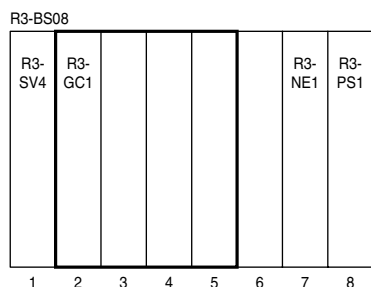

SLOT	REAL MODULE	VIRTUAL MODULE	NO. OF WORDS
Slot No. 1	R3-SV4	R3-SV4	4 Words
Slot No. 2	R3-GC1	R3-GC1 (1/4)	16 Words
Slot No. 3	No module	R3-GC1 (2/4)	16 Words
Slot No. 4	No module	R3-GC1 (3/4)	16 Words
Slot No. 5	No module	R3-GC1 (4/4)	16 Words
Slot No. 6	No module	No module	----
Slot No. 7	R3-NE1	R3-NE1	----
Slot No. 8	R3-PS1	R3-PS1	----

■ OUTPUT DATA

The figure below shows the allocation of the data sent from the network module to the master.

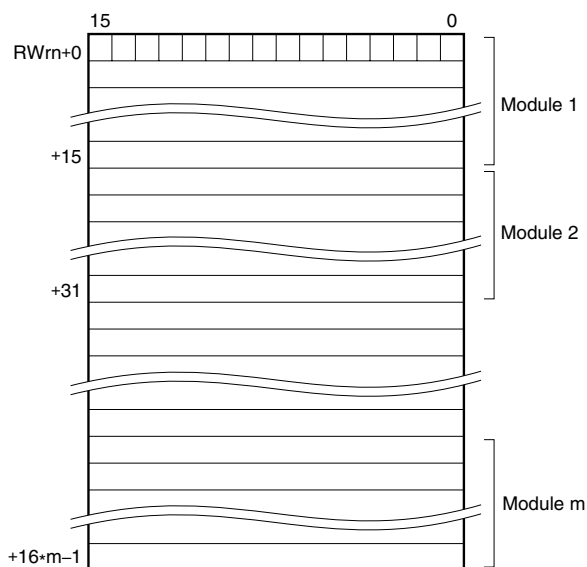

■ INPUT DATA

The figure below shows the allocation of the data sent from the master to the network module.

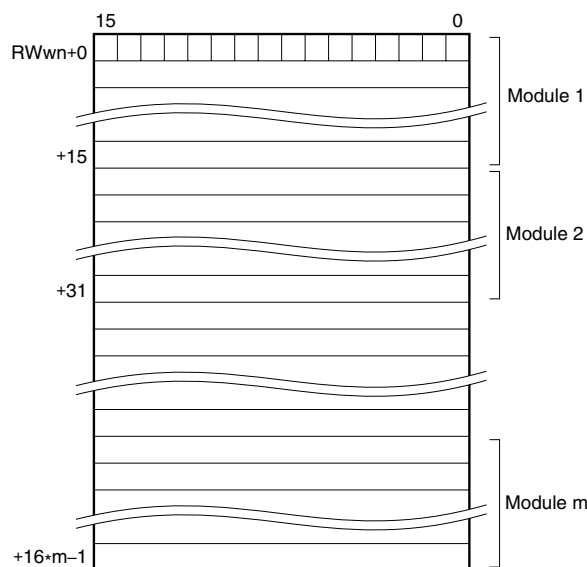

- The available data area for R3-GC1 is [16*m] (m=expanded cyclic setting)
CC-Link Ver.1.10

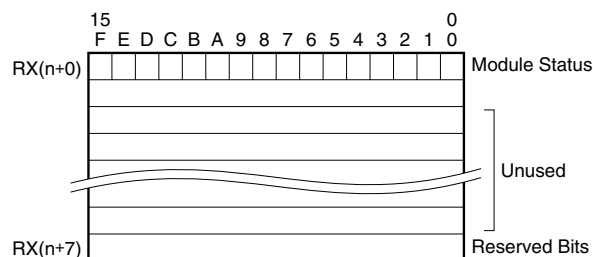

CC-Link Ver.2.00

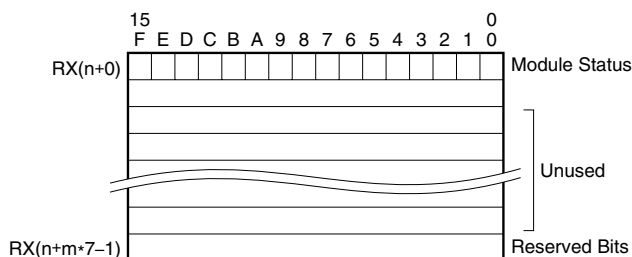

• **CC-Link Ver.1.10**

1. Module Status

RX (n + 0) 0 indicates whether a virtual I/O module is specified or not.

The virtual I/O module is a fixed one for CC-Link Ver.1.10, the related bit must be "1".

RX (n + 0) 0 Virtual I/O module 1

2. RX (n + 1) to RX (n + 6) are not used.

3. RX (n + 7) 0 to RX (n + 7) 7 is a reservation area.

RX (n + 7) B is used as Ready signal, the bit is "1" when R3-GC1 is in normal.

RX (n + 7) 8 to A, C to F are not used.

• **CC-Link Ver.2.00**

1. Module Status

RX (n + 0) 0 to RX (n + 0) 7 indicates whether virtual I/O modules are specified or not.

When a virtual module is specified, the related bit is "1". When a virtual module is not specified, the related bit is "0".

The detailed information is as shown below.

RX (n + 0) 0 Virtual I/O module 1

RX (n + 0) 1 Virtual I/O module 2

RX (n + 0) 2 Virtual I/O module 3

RX (n + 0) 3 Virtual I/O module 4

RX (n + 0) 4 Virtual I/O module 5

RX (n + 0) 5 Virtual I/O module 6

RX (n + 0) 6 Virtual I/O module 7

RX (n + 0) 7 Virtual I/O module 8

2. RX (n + 1) to RX (n + m * 7 - 2) are not used.

3. RX (n + m * 7 - 1) 0 to RX (n + m * 7 - 1) 7 is a reservation area.

RX (n + m * 7 - 1) B is used as Ready signal, the bit is "1" when R3-GC1 is in normal.

RX (n + m * 7 - 1) 8 to A, C to F are not used.