

BEFORE USE

Thank you for choosing us. Before use, please check contents of the package you received as outlined below. If you have any problems or questions with the product, please contact our sales office or representatives.

■ PACKAGE INCLUDES:

Interface I/O module(1)

■ MODEL NO.

Confirm Model No. marking on the product to be exactly what you ordered.

■ INSTRUCTION MANUAL

This manual describes necessary points of caution when you use this product, including installation, connection and basic maintenance procedures.

POINTS OF CAUTION

■ CONFORMITY WITH EU DIRECTIVES

- The equipment must be mounted inside the instrument panel of a metal enclosure.
- The actual installation environments such as panel configurations, connected devices, connected wires, may affect the protection level of this unit when it is integrated in a panel system. The user may have to review the CE requirements in regard to the whole system and employ additional protective measures to ensure the CE conformity.

■ HOT SWAPPABLE MODULES

- The module can be replaced while the power is ON. Be sure to replace it when the module is not communicating with a host, as it may affect the system. Replacing multiple modules at once may greatly change line voltage levels. We highly recommend to replace them one by one.

■ GENERAL PRECAUTIONS

- DO NOT set the switches on the module while the power is supplied. The switches are used only for maintenance with the power supply turned off.

■ ENVIRONMENT

- Indoor use.
- When heavy dust or metal particles are present in the air, install the unit inside proper housing with sufficient ventilation.
- Do not install the unit where it is subjected to continuous vibration. Do not apply physical impact to the unit.
- Environmental temperature must be within -10 to +55°C (14 to 131°F) with relative humidity within 30 to 90% RH in order to ensure adequate life span and operation.

■ WIRING

- Do not install cables close to noise sources (relay drive cable, high frequency line, etc.).
- Do not bind these cables together with those in which noises are present. Do not install them in the same duct.

■ AND

- The unit is designed to function as soon as power is supplied, however, a warm up for 10 minutes is required for satisfying complete performance described in the data sheet.

INSTALLATION

Use the Installation Base Model: R3-BS or Model: R3-BSW which allows free I/O address setting.

■ INSTALLATION TO THE BASE

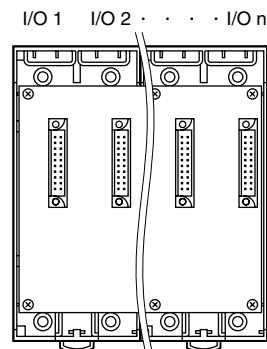

With Model R3-BS base, mount I/O modules and interface I/O modules from the left end (I/O 1) to the right in order. The network module assigns data areas from I/O 1 accordingly.

Network module(s) and power supply module(s) are mounted basically to the right of the I/O modules and interface I/O modules or at the right end of the base although technically they could be mounted in any position.

With Model R3-BSW base, there is no limitation in mounting positions as I/O addresses can be arbitrarily assigned to respective modules using rotary switches equipped on the base.

R3-GSLMP1 occupies up to 16 slots. Be careful not to use the slot numbers occupied by this unit for real I/O modules to be mounted on the same base. Also, when mounting this unit, be careful about the slot position and the number of slots to be occupied so that any of the slot numbers will not be greater than 16. The Network module cannot read data for an I/O module assigned to slot No. 17 or later.

COMPONENT IDENTIFICATION

FRONT VIEW

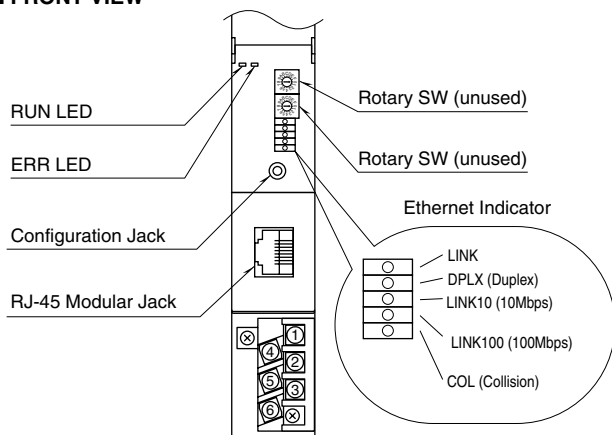

SIDE VIEW

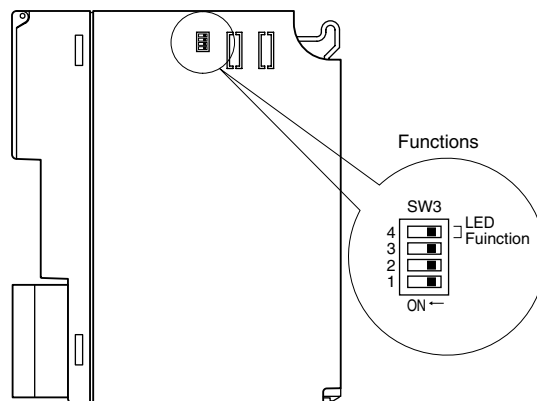

ETHERNET INDICATOR

ID	COLOR	FUNCTION
LINK	Red	ON at LINK
DPLX	Red	ON at full-duplex communication
LINK10	Red	ON at 10 Mbps connection
LINK100	Red	ON at 100 Mbps connection
COL	Red	Blinks at collision

SIDE DIP SW

LED Function: SW3-4

Functions assigned to the front RUN and ERR LEDs can be selected.

SW3-4	LED FUNCTION	
	RUN	ERR
OFF (*)	Green turns ON when SLMP communication is normal and fieldbus communication on the R3 Network module side is also normal	Green turns ON/blinks in communication errors (OFF with wire breakdown; Green blinks with setting errors)
ON	Red turns ON when receiving data	Red turns ON when transmitting data

(*) Factory default

Note: Be sure to set unused SW3-1 to 3-3 to OFF.

PC CONFIGURATOR

With the configurator software (model: R3CON), parameters shown below are configurable. Refer to the users manual of R3CON for detailed operation.

■ SLMP SETTINGS

ITEM	SETTING RANGE	DEFAULT SETTING
Pause period *1	0 – 10000 (msec.)	100 (msec.)
IP address	0.0.0.0 – 255.255.255.255	192.168.0.1
Subnet mask	0.0.0.0 – 255.255.255.255	255.255.255.0
Default gateway	0.0.0.0 – 255.255.255.255	192.168.0.100
Protocol type *2	16 bit, 32 bit	32 bit
Processor No.	0000 – FFFF	03FF
SLMP timeout	1 – 10 (sec.)	3 (sec.)
Network No.	0 – 239	0
Stations No.	1 – 120, 125, 126, 255	255
SLMP server IP address	0.0.0.0 – 255.255.255.255	192.168.0.2
SLMP server Port No.	0 – 65535	8192
Entry No. *3	0 – 16	0

*1. Command transmitting intervals to SLMP server.

*2. Determined by the model of SLMP server (PLC).

*3. The number of entries (registrations) of commands sent to SLMP server.

■ CARD SETTINGS

ITEM	FUNCTION	RANGE
I/O type	I/O type	AI (Analog Input), AO (Analog Output), DI (Digital Input), DO (Digital Output)
Ch. No.	No. of channels *4	1 – 16
SLMP device	Device type *5	Device from/in which to read/write
Device address Hex.	Device address Hex.*6	Begin address of read and write memory (hexadecimal)
Device address Dec.	Device address Dec.*6	Begin address of read and write memory (decimal)

*4. Specify the number of the device to read/write. For example, set to “8”, reads 8 points from the specified “Device address” (begin address of the memory). The total numbers of channels set in Entry No. must be 128 or less.

*5. Available devices differ depend on the settings of protocol type and I/O type (Refer to Table “SLMP SETTINGS” above).

*6. Hexadecimal or decimal is determined by the device type.

TERMINAL CONNECTIONS

Connect the unit as in the diagram below.

EXTERNAL DIMENSIONS unit: mm (inch)

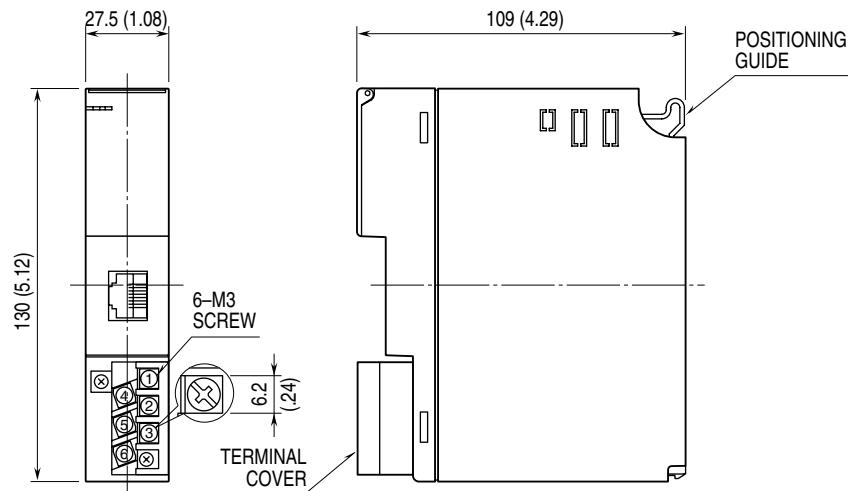

CONNECTION DIAGRAM

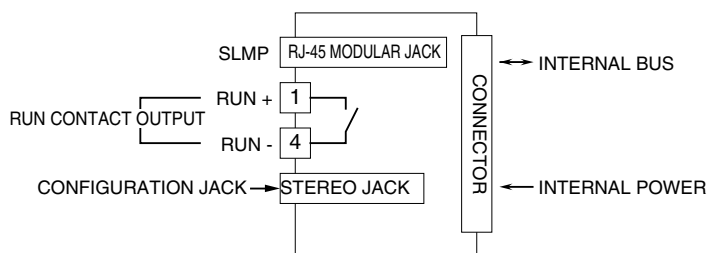

WIRING INSTRUCTIONS

M3 SCREW TERMINAL

Torque: 0.5 N·m

SOLDERLESS TERMINAL unit: mm (inch)

Refer to the drawing below for recommended ring tongue terminal size. Spade tongue type is also applicable. Solderless terminals with insulation sleeve do not fit.

Applicable wire size: 0.75 – 1.25 mm²

Recommended manufacturer: Japan Solderless Terminal MFG. Co.,Ltd., Nichifu Co.,Ltd.

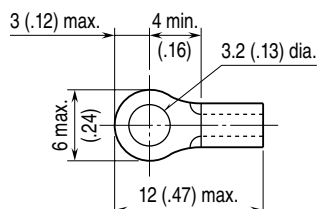

TRANSMISSION DATA DESCRIPTIONS

R3-GSLMP1 reads/writes data from/in devices in SLMP-compatible CPU of Mitsubishi programmable controller MELSEC using SLMP. Devices from/in which data is read/written and addresses using SLMP are set on R3CON.

Mount the R3-GSLMP1 on the R3 base. Virtual input module sends the data read from SLMP server to the host PLC as an input data via R3 Interface module. Two signal types; AI (analog input) and DI (digital input) are available as virtual input module. Flow of the signal is as following.

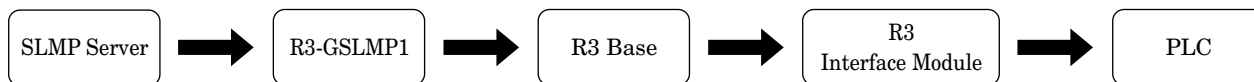

Virtual output module writes in the data written to the R3 Interface module from the host PLC, to the SLMP server. Two signal types; AO (analog output) and DO (digital output) are available as virtual output module. Flow of the signal is as following.

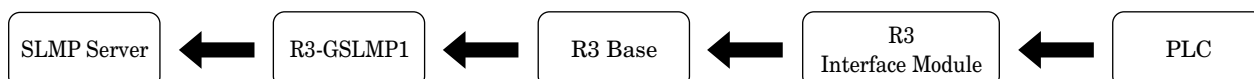

To read/write data from/in devices, 4 types of I/O are available. Refer to the following table.

· I/O TYPE:

	READ/WRITE	TRANSMITTING POINTS per MODULE	DATA ALLOCATION MODE	VIRTUAL I/O MODULE TYPE
AI (Analog input)	Read	16 points max.	16	Virtual input module
DI (Digital input)	Read	16 points max.	1	Virtual input module
AO (Analog output)	Write	16 points max.	16	Virtual output module
DO (Analog output)	Write	16 points max.	1	Virtual output module

The devices of the SLMP server are allocated to the virtual input module and the virtual output module of the R3-GSLMP1 by setting the R3-GSLMP1's I/O type, number of channels, device type and device address with R3CON.

- Device Address: Begin address of read/write device (specify with hexadecimal or decimal)
- Channel Number: 1 - 16 (Specify the number of data to read/write from begin address)

· Device: Commands to read from/write in the device (Refer to the following table for available device types)

AVAILABLE DEVICE TYPES

AI / AO 32 bit	AI / AO 16 bit	DI / DO 32 bit	DI / DO 16 bit
SD: Special Register	SD: Special Register	SM: Special relay	SM: Special relay
D: Data Register	D: Data Register	X: Input	X: Input
W: Link Register	W: Link Register	Y: Output	Y: Output
TN: Timer, Current value	TN: Timer, Current value	M: Internal relay	M: Internal relay
STN: Retentive timer, Current value	STN: Retentive timer, Current value	L: Latch relay	L: Latch relay
CN: Counter, Current value	CN: Counter, Current value	F: Annunciator	F: Annunciator
SW, Link special Register	SW, Link special Register	V: Edge relay	V: Edge relay
Z: Index Register	Z: Index Register	B: Link relay	B: Link relay
R: File Register	R: File Register	–	S: STEP RELAY
ZR: File Register	ZR: File Register	TS: Timer, Contact	TS: Timer, Contact
RD: Module refresh Register	–	TC: Timer, Coil	TC: Timer, Coil
		LTS: Long timer, Contact	–
		LTC: Long timer, Coil	–
		STS: Retentive timer, Contact	STS: Retentive timer, Contact
		STC: Retentive timer, Coil	STC: Retentive timer, Coil
		LSTS: Long retentive timer, Contact	–
		LSTC: Long retentive timer, Coil	–
		CS: Counter, Contact	CS: Counter, Contact
		CC: Counter, Coil	CC: Counter, Coil
		LCS: Long counter, Contact	LCS: Long counter, Contact
		LCC: Long counter, Coil	LCC: Long counter, Coil
		SB: Link special relay	SB: Link special relay

Max. 16 points of analog input/output and max. 16 points of digital input/output can be allocated per a virtual module. Set the data allocation to 16 for the slot with the virtual analog input/output module, and set 1 for the slot with virtual digital input/output module by data allocation mode of the R3 Interface module.

Note: Numbers of transmittable data is limited by number of channel and virtual module. R3-GSLMP1 can transmitted max. 128 channels or 16 virtual modules. Even though the total number of channels is less than 128, if the total number of virtual modules is 16, number of channel cannot be increased.

Do not mount any modules in the slots which are occupied by virtual modules. If a real I/O module is mounted in the slot, an internal bus error occurs and the ERR LED turns on. Max. 16 real I/O modules and virtual modules are available. The R3 interface module can not read the data for more than 16 modules.

Details are explained in “■ Number of the modules and the address allocation” on the next page.

■ NUMBER of the MODULES and the ADDRESS ALLOCATION

· DEVICE CONFIGURATION EXAMPLE 1

Device setting

I/O TYPE	CH. NO.	SLMP DEVICE	DEVICE ADDRESS
AI	2	SD	0x000
AI	4	D	0x000
AI	8	W	0x000
AI	3	TN	0x000
AI	10	SW	0x000

· Virtual I/O modules configuration

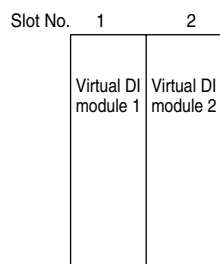

Data Allocation 1 1

· Data configuration

CH	ADDRESS	VIRTUAL AI MODULE 1 (SLOT NO.1)	ADDRESS	VIRTUAL AI MODULE 2 (SLOT NO.2)
1	n+0	SD 000	n+16	TN 002
2	n+1	SD 001	n+17	SW 000
3	n+2	D 000	n+18	SW 001
4	n+3	D 001	n+19	SW 002
5	n+4	D 002	n+20	SW 003
6	n+5	D 003	n+21	SW 004
7	n+6	W 000	n+22	SW 005
8	n+7	W 001	n+23	SW 006
9	n+8	W 002	n+24	SW 007
10	n+9	W 003	n+25	SW 008
11	n+10	W 004	n+26	SW 009
12	n+11	W 005	n+27	-
13	n+12	W 006	n+28	-
14	n+13	W 007	n+29	-
15	n+14	TN 000	n+30	-
16	n+15	TN 001	n+31	-

In this example, total numbers of channels are 20 and uses 2 virtual AI modules. Real I/O modules are mounted on Slots No. 1 and 2, however, the network module (R3-NC3) recognizes that each of Slots No. 1 to 3 is occupied. That is, R3-NC3 recognizes R3-SV4 mounted on Slot No.1 as it is and recognizes R3-GSLMP1 mounted on Slot No.2 as divided into two modules and occupying Slots No. 2 and 3.

R3-BS06

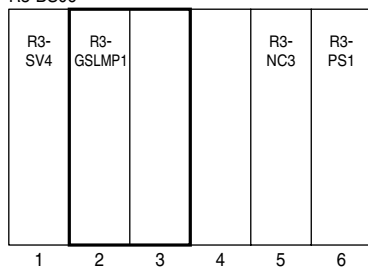

SLOT	REAL MODULE	VIRTUAL MODULE	DATA ALLOCATION	NO. OF WORDS
Slot No. 1	R3-SV4	-	4	4 words
Slot No. 2	R3-GSLMP1	R3-GSLMP1 (1/2)	16	16 words
Slot No. 3	No module	R3-GSLMP1 (2/2)	16	16 words
Slot No. 4	No module	-	-	-
Slot No. 5	R3-NC3	-	-	-
Slot No. 6	R3-PS1	-	-	-

· DEVICE CONFIGURATION EXAMPLE 2

Device setting

I/O TYPE	CH. NO.	SLMP DEVICE	DEVICE ADDRESS
DI	10	X	0x000
DI	2	M	0x000
DI	8	Y	0x000

· Virtual I/O modules configuration

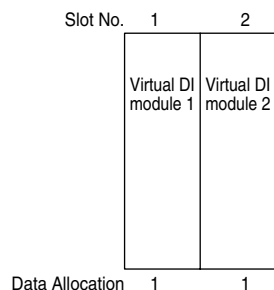

· Data configuration

CH	ADDRESS	F	E	D	C	B	A	9	8	7	6	5	4	3	2	1	0
Virtual DI module 1	n+0	Y3	Y2	Y1	Y0	M1	M0	X9	X8	X7	X6	X5	X4	X3	X2	X1	X0
Virtual DI module 2	n+1	-	-	-	-	-	-	-	-	-	-	-	-	Y7	Y6	Y5	Y4

In this example, total numbers of channels are 20 and uses 2 virtual DI modules. Real I/O modules are mounted on Slots No. 1 and 2, however, the network module (R3-NC3) recognizes that each of Slots No. 1 to 3 is occupied. That is, R3-NC3 recognizes R3-SV4 mounted on Slot No.1 as it is and recognizes R3-GSLMP1 mounted on Slot No.2 as divided into two modules and occupying Slots No. 2 and 3.

R3-BS06

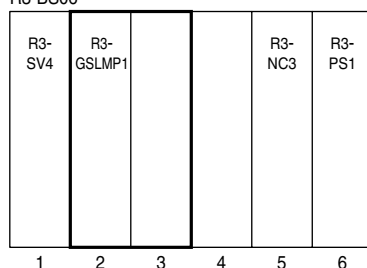

SLOT	REAL MODULE	VIRTUAL MODULE	DATA ALLOCATION	NO. OF WORDS
Slot No. 1	R3-SV4	-	4	4 words
Slot No. 2	R3-GSLMP1	R3-GSLMP1 (1/2)	1	1 words
Slot No. 3	No module	R3-GSLMP1 (2/2)	1	1 words
Slot No. 4	No module	-		-
Slot No. 5	R3-NC3	-		-
Slot No. 6	R3-PS1	-		-

· DEVICE CONFIGURATION EXAMPLE 3

Device setting

I/O TYPE	CH. NO.	SLMP DEVICE	DEVICE ADDRESS
AI	20	D	0x000
DI	20	X	0x000
DI	20	M	0x000

· Virtual I/O modules configuration

Slot No.	1	2	3	4	5
	Virtual AI module 1	Virtual AI module 2	Virtual DI module 1	Virtual DI module 2	Virtual DI module 3

Data Allocation 16 16 1 1 1

· Data configuration

Ch	ADDRESS	VIRTUAL AI MODULE 1 (Slot 1)	ADDRESS	VIRTUAL AI MODULE 2 (Slot 2)	ADDRESS	VIRTUAL DI MODULE 1 (Slot 3)	ADDRESS	VIRTUAL DI MODULE 2 (Slot 4)	ADDRESS	VIRTUAL DI MODULE 3 (Slot 5)
1	n+0	D 000	n+16	D 016	n+32	X0 – 15	n+33	X16 – 19, M0 – 11	n+34	M12 – 19
2	n+1	D 001	n+17	D 017						
3	n+2	D 002	n+18	D 018						
4	n+3	D 003	n+19	D 019						
5	n+4	D 004	n+20	–						
6	n+5	D 005	n+21	–						
7	n+6	D 006	n+22	–						
8	n+7	D 007	n+23	–						
9	n+8	D 008	n+24	–						
10	n+9	D 009	n+25	–						
11	n+10	D 010	n+26	–						
12	n+11	D 011	n+27	–						
13	n+12	D 012	n+28	–						
14	n+13	D 013	n+29	–						
15	n+14	D 014	n+30	–						
16	n+15	D 015	n+31	–						

	ADDRESS	F	E	D	C	B	A	9	8	7	6	5	4	3	2	1	0
Virtual DI module 1	n+32	X15	X14	X13	X12	X11	X10	X9	X8	X7	X6	X5	X4	X3	X2	X1	X0
Virtual DI module 2	n+33	M11	M10	M9	M8	M7	M6	M5	M4	M3	M2	M1	M0	X19	X18	X17	X16
Virtual DI module 3	n+34	–	–	–	–	–	–	–	–	M19	M18	M17	M16	M15	M14	M13	M12

In this example, total numbers of AI channels are 20, total numbers of DI channels are 40 and uses total 5 virtual modules (2 virtual AI modules and 3 virtual DI modules). Real I/O modules are mounted on Slots No. 1 and 2, however, the network module (R3-NC3) recognizes that each of Slots No. 1 to 6 is occupied. That is, R3-NC3 recognizes R3-SV4 mounted on Slot No.1 as it is and recognizes R3-GSLMP1 mounted on Slot No.2 as divided into 5 modules and occupying Slots No. 2 and 6.

R3-BS06

1	2	3	4	5	6	7	8
R3-SV4	R3-GSLMP1					R3-NC3	R3-PS1

SLOT	REAL MODULE	VIRTUAL MODULE	DATA ALLOCATION	NO. OF WORDS
Slot No. 1	R3-SV4	–	4	4 words
Slot No. 2	R3-GSLMP1	R3-GSLMP1 (1/5)	16	16 words
Slot No. 3	No module	R3-GSLMP1 (2/5)	16	16 words
Slot No. 4	No module	R3-GSLMP1 (3/5)	1	1 words
Slot No. 5	No module	R3-GSLMP1 (4/5)	1	1 words
Slot No. 6	No module	R3-GSLMP1 (5/5)	1	1 words
Slot No. 7	R3-NC3	–		–
Slot No. 8	R3-PS1	–		–

INPUT/OUTPUT DATA

■ VIRTUAL ANALOG I/O DATA

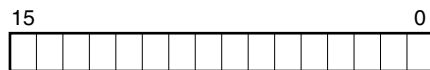

16-bit binary data

■ VIRTUAL DIGITAL I/O DATA

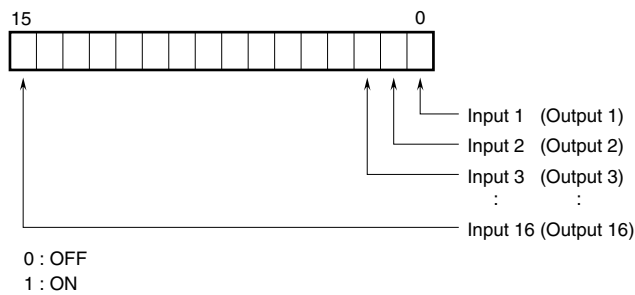

■ ANALOG/DIGITAL INPUT DATA

- When the R3-GSLMP1 cannot communicate with SLMP server at the start up, AI or DI data turn to 0.
- When the communication between the R3-GSLMP1 and the SLMP server is lost due to an error, the last process values are held until the communication is re-established.

■ ANALOG/DIGITAL OUTPUT DATA

- When the R3-GSLMP1 does not starting communication with SLMP server at the start up, write AI or DI data of 0 to the SLMP server.
- When the communication between the R3 Interface module and the host PLC is lost, the last process values are write in the SLMP server. The values are held until the communication is re-established.