

BEFORE USE

Thank you for choosing us. Before use, please check contents of the package you received as outlined below. If you have any problems or questions with the product, please contact our sales office or representatives.

■ PACKAGE INCLUDES:

Network interface module(1)

■ MODEL NO.

Confirm Model No. marking on the product to be exactly what you ordered.

■ INSTRUCTION MANUAL

This manual describes necessary points of caution when you use this product, including installation, connection and basic maintenance procedures.

■ EDS FILE

EDS files are downloadable at our web site.

POINTS OF CAUTION

■ CONFORMITY WITH EU DIRECTIVES

- The equipment must be mounted inside the instrument panel of a metal enclosure.
- The actual installation environments such as panel configurations, connected devices, connected wires, may affect the protection level of this unit when it is integrated in a panel system. The user may have to review the CE requirements in regard to the whole system and employ additional protective measures to ensure the CE conformity.

■ HOT SWAPPABLE MODULES

- The module can be replaced while the power is ON. Be sure to replace it when the module is not communicating with a host, as it may affect the system. Replacing multiple modules at once may greatly change line voltage levels. We highly recommend to replace them one by one.

■ GENERAL PRECAUTIONS

- DO NOT set the switches on the module while the power is supplied. The switches are used only for maintenance without the power.

■ ENVIRONMENT

- Indoor use.
- When heavy dust or metal particles are present in the air, install the unit inside proper housing with sufficient ventilation.
- Do not install the unit where it is subjected to continuous vibration. Do not subject the unit to physical impact.
- Environmental temperature must be within -10 to +55°C (14 to 131°F) with relative humidity within 30 to 90% RH in order to ensure adequate life span and operation.

■ WIRING

- Do not install cables close to noise sources (relay drive cable, high frequency line, etc.).
- Do not bind these cables together with those in which noises are present. Do not install them in the same duct.

■ AND

- The unit is designed to function as soon as power is supplied, however, a warm up for 10 minutes is required for satisfying complete performance described in the data sheet.

Note: Not connectable beyond router.

INSTALLATION

Use the Installation Base Model R3-BS, or Model R3-BSW for free I/O address capability.

Before mounting the Network Interface Module onto the Base, be sure to configure the module as explained below.

■ DATA ALLOCATION

The setting determines the data area size assigned to each I/O module mounted on the base.

The data sent/received via EtherNet/IP is mapped according to this setting.

See “COMPONENT IDENTIFICATION” and “TRANSMISSION DATA DESCRIPTIONS”.

■ I/O DATA AREA SIZE

The I/O data area is set with DIP switch (SW3) on the side of the module. That sets the size of data on the EtherNet/IP.

■ NETWORK SLOTS ON THE BASE

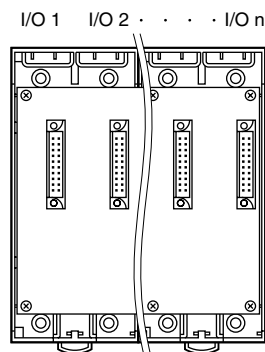

With Model R3-BS base, mount the I/O Modules from the left end (I/O 1) to the right in order that the Network Module assigns data areas from I/O 1.

Network Module(s) and Power Module are mounted basically at the right end though technically they could be mounted in any position.

With Model R3-BSW base, there is no limitation in mounting positions as I/O address can be assigned freely to each module using rotary switches equipped on the base.

COMPONENT IDENTIFICATION

FRONT VIEW

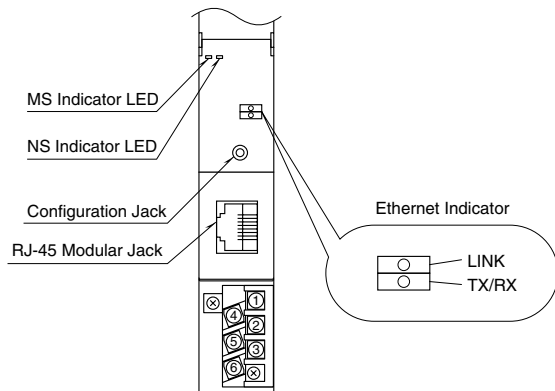

SIDE VIEW

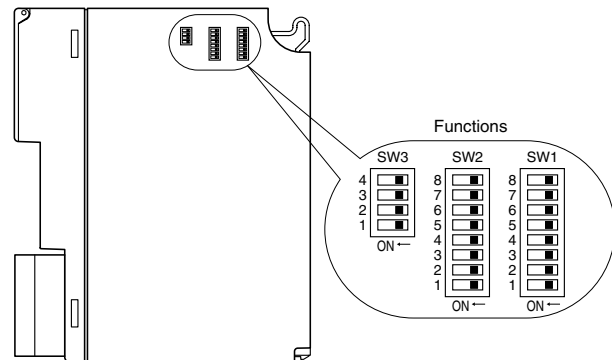

INDICATORS

The following table defines the LED states of the MS, and NS indicators.

ID	STATE	TO INDICATE
MS	Green	Operating in a normal condition
	Blinking Green	Standby (needs commissioning)
	Red	Critical failure
	Blinking Red	Minor failure
	OFF	No power supplied
NS	Green	Link on-line and connections in the established state
	Blinking Green	Link on-line but no connections in the established state
	Red	Critical link failure
	Blinking Red	Minor link failure
	OFF	No power supplied

Ethernet Indicators

LINK: Turns on when the link is established

TX/RX: Turns on during transmitting or receiving data

SIDE DIP SW

(*) Factory setting

Data Allocation: SW1, SW2

Data Allocation Type* must be assigned to each I/O module position to specify how many data areas (four types) are to be occupied by each.

Two bits from SW1 and SW2 are assigned to each position, and data areas can be specified from the module No. 1 through 8. Setting for No. 9 and later modules is identical to No. 8.

SW ASSIGNMENT		MODULE NO.
SW1-1	SW1-2	1
SW1-3	SW1-4	2
SW1-5	SW1-6	3
SW1-7	SW1-8	4
SW2-1	SW2-2	5
SW2-3	SW2-4	6
SW2-5	SW2-6	7
SW2-7	SW2-8	8

SW SETTING		DATA ALLOCATION
OFF	OFF	1
ON	OFF	4
OFF	ON	8
ON	ON	16

* Refer to the specifications of the related series for the Data Allocation Type of I/O modules.

Dual Communication: SW3-1

When two network modules are mounted, one must be 'Main' (OFF) network and the other must be 'Sub' (ON) network. For single communication, the network module must always be set to 'Main' (OFF).

SW	DUAL COMMUNICATION	
	MAIN (*)	SUB
SW3-1	OFF	ON

Input Error Data: SW3-2

Hold: When the communication from an input module is lost due to the input module error, the network module holds the signal and stands by until the communication recovers.

Set to '0': When the communication from an input module is lost due to the input module error, the network module outputs '0'.

SW	INPUT ERROR DATA	
	HOLD (*)	SET '0'
SW3-2	OFF	ON

I/O Data Area: SW3-3, 3-4

INPUT AREA (Word)	OUTPUT AREA (Word)	SW3-3	SW3-4
35	35	OFF (*)	OFF (*)
67	67	ON	OFF
131	131	OFF	ON
252	252	ON	ON

PC CONFIGURATOR

The following parameter items can be set with using PC Configurator Software (model: R3CON). Refer to the users manual for the R3CON for detailed operation of the software program.

NETWORK MODULE SETTING

PARAMETER	SETTING RANGE	DEFAULT SETTING
Time (no communication time)	0.2 – 3200.0 (sec.)	3.0 (sec.)
IP Address	0.0.0.0 – 255.255.255.255	192.168.0.1
Subnet Mask	0.0.0.0 – 255.255.255.255	255.255.255.0
Default Gateway	0.0.0.0 – 255.255.255.255	192.168.0.1

TERMINAL CONNECTIONS

Connect the unit as in the diagram below.

EXTERNAL DIMENSIONS unit: mm (inch)

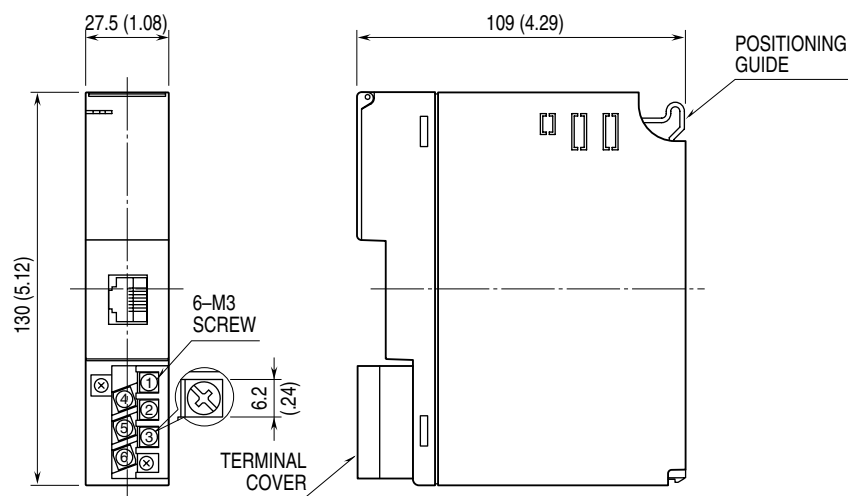

CONNECTION DIAGRAM

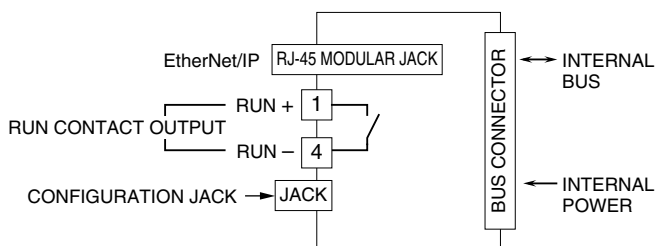

WIRING INSTRUCTIONS

M3 SCREW TERMINAL

Torque: 0.5 N·m

SOLDERLESS TERMINAL

Refer to the drawing below for recommended ring tongue terminal size. Spade tongue type is also applicable. Solderless terminals with insulation sleeve do not fit.

Recommended manufacturer: Japan Solderless Terminal MFG.Co.Ltd, Nichifu Co.,Ltd

Applicable wire size: 0.75 to 1.25 mm²

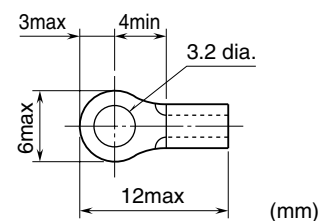

CHECKING ETHERNET CONNECTION

■ IP ADDRESS

The IP address is set with PC Configurator Software (model: R3CON). BOOTP and DHCP are also available.

■ DATA ALLOCATION

Data Allocation Type must be assigned to each I/O module position to specify how many data areas (four types) are to be occupied by each.

Two bits from SW1 and SW2 are assigned to each position on the base.

■ CHECK WIRING

Connect an Ethernet cable to the front RJ-45 jack.

■ CHECK LED

When wiring is correct, LINK is turned on.

■ CHECK R3-NEIP1 CONNECTION

Enter “ping command” on the Windows MS-DOS as follows:

```
C:\WINDOWS>ping ***.***.***.***
(***.***.***.***, Enter IP address in decimal.)

ping ***.***.***.*** with 32 bytes of data:
Reply from ***.***.***.*** : bytes=32 time<10ms TTL=64
Reply from ***.***.***.*** : bytes=32 time<10ms TTL=64
Reply from ***.***.***.*** : bytes=32 time<10ms TTL=64
Reply from ***.***.***.*** : bytes=32 time<10ms TTL=64

Ping statistics for ***.***.***.***
Packets:Sent=4,Received=4,Lost=0(0% loss)
```

Replies in case of normal connection are as shown above. If the connection cannot be established normally due to e.g. wrong IP address, other replies such as “time over” will be received.

■ CHECK CONNECTION TO THE APPLICATION SOFTWARE

Check Point 1: LINK LED

When a normal connection is established, the front LINK is turned on regardless of data sending/receiving status. Check power supply to the hub in case that these LEDs are not on.

Check Point 2: MS, NS and Ethernet indicators

When the module transmits or receives data correctly, MS, NS and TX/RX indicators turn on. Since the transfer rate is high, TX/RX indicator seems to blink.

TRANSMISSION DATA DESCRIPTIONS

The DIP SW located at the side of the module specifies each I/O module's data allocation (occupied data area and size of the I/O data area).

For example, when the data areas are assigned as shown below:

Module 1	4
Module 2	4
Module 3	4
Module 4	1
Module 5	1
Module 6	1
Module 7	1

I/O data area: 252 words each for input and output.

Then the I/O data are assigned as in the figures below:

■ OUTPUT DATA

The figure below shows the allocation of the data sent from the network module to the master.

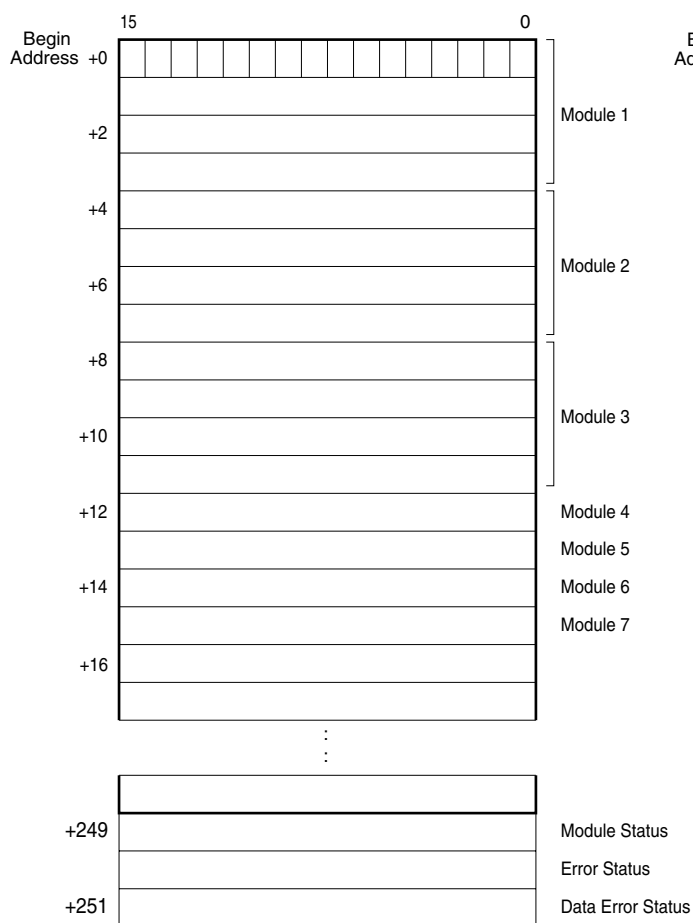

The area enclosed with bold line is assigned for I/O data

■ INPUT DATA

The figure below shows the allocation of the data sent from the master to the network module.

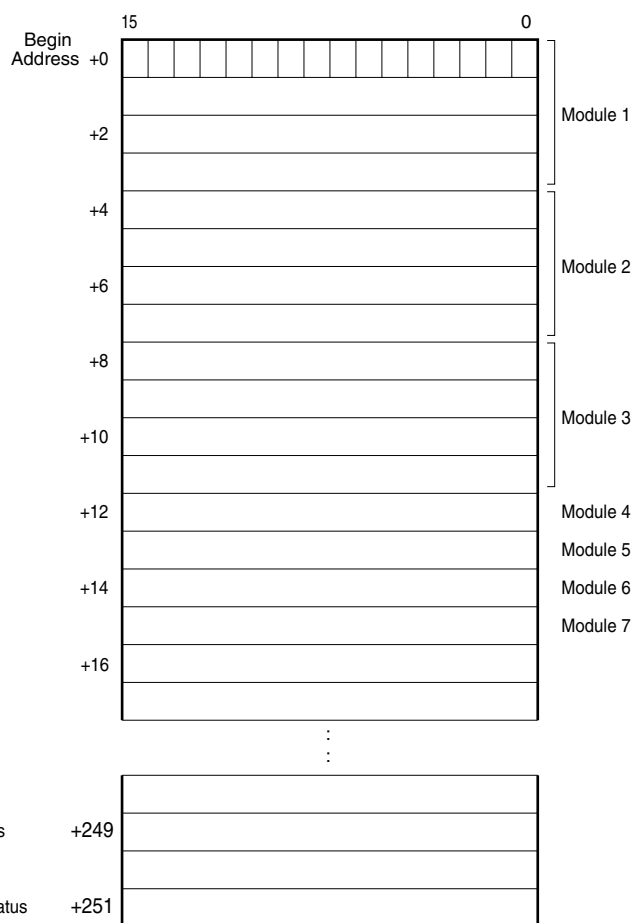

Module Status, Error Status and Data Error Status are assigned to the last three words of the output data respectively. Each module can handle either input or output data.

- Module Status indicates whether individual I/O modules are mounted or not. The bit corresponding to the mounted slot turns to "1," and the unmounted slot to "0."
- Error Status indicates error status for each module as described below. The bit corresponding to such module turns to "1."
 - R3-TSx, R3-RSx, R3-US4: Input burnout
 - R3-DA16A: Power input in error or disconnected
 - R3-YSx: Output current error (e.g. load unconnected)
 - R3-PC16A: External power supply in error or disconnected
- Data Error Status indicates overrange (R3-US4: out of -10% to +110%; the other types: out of -15% to +115%) status for each

module. The bit corresponding to such module turns to "1."

MODULE STATUS, ERROR STATUS, DATA ERROR STATUS

Shows each module's availability and error status.

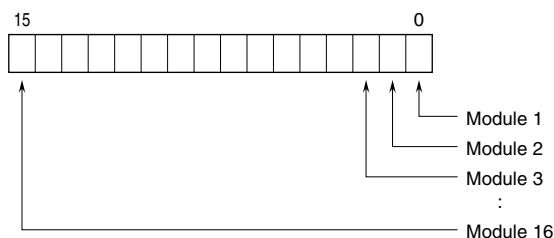

I/O DATA DESCRIPTIONS

The data allocations for typical I/O modules are shown below.
Refer to the manual for each module for detailed data allocations.

■ ANALOG DATA (16-bit data, models: R3-SV4, YV4, DS4, YS4 and US4, etc.)

16-bit binary data.

Basically, 0 to 100% of the selected I/O range is converted into 0 to 10000 (binary).

-15 to 0 % is a negative range represented in 2's complement.

In case of R3-US4, -10 to 0% is a negative range represented in 2's complement.



■ TEMPERATURE DATA (16-bit data, models: R3-RS4, TS4 and US4, etc.)

16-bit binary data.

With °C temperature unit, raw data is multiplied by 10. For example, 25.5°C is converted into 255.

With °F temperature unit, the integer section of raw data is directly converted into the data. For example, 135.4°F is converted into 135.

Minus temperature is converted into negative values, represented in 2's complements.

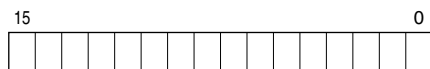

■ ANALOG DATA (16-bit data, models: R3-CT4A, CT4B, etc.)

16-bit binary data.

Integer obtained by multiplying unit value (A) by 100.

In case of CLSE-R5, integer obtained by multiplying unit value (A) by 1000.

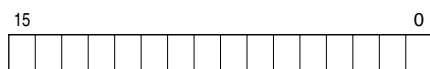

■ ACCUMULATED COUNT DATA (32-bit data, models: R3-PA2, PA4A, WT1, WT4, etc.)

32-bit binary data is used for accumulated counts and encoder positions.

Lower 16 bits are allocated from the lowest address to higher ones, higher 16 bits in turn.



■ BCD DATA (32-bit data, models: R3-BA32A, BC32A, etc.)

32-bit binary data is used for BCD.

Lower 16 bits are allocated from the lowest address to higher ones, higher 16 bits in turn.

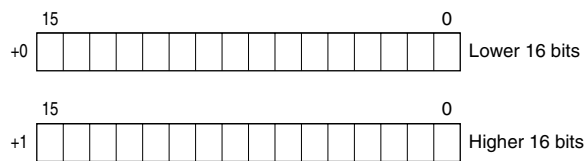

■ DISCRETE DATA (models: R3-DA16 and DC16, etc.)

