

<p><b>T-Link INTERFACE MODULE</b> (Fuji Electric T-Link interface module equivalent)</p>	<p>MODEL <b>R3-NF2</b></p>
--	----------------------------

**BEFORE USE ....**

Thank you for choosing us. Before use, please check contents of the package you received as outlined below. If you have any problems or questions with the product, please contact our sales office or representatives.

**■ PACKAGE INCLUDES:**

Network interface module .....(1)

**■ MODEL NO.**

Confirm Model No. marking on the product to be exactly what you ordered.

**■ INSTRUCTION MANUAL**

This manual describes necessary points of caution when you use this product, including installation, connection and basic maintenance procedures.

**POINTS OF CAUTION**

**■ HOT SWAPPABLE MODULES**

- The module can be replaced while the power is ON. Be sure to replace it when the module is not communicating with a host, as it may affect the system. Replacing multiple modules at once may greatly change line voltage levels. We highly recommend to replace them one by one.

**■ POWER INPUT RATING & OPERATIONAL RANGE**

- Locate the power input rating marked on the product and confirm its operational range as indicated below:  
 100 – 120V AC rating: 85 – 132V, 47 – 66 Hz, approx. 20VA  
 200 – 240V AC rating: 170 – 264V, 47 – 66 Hz, approx. 20VA  
 24V DC rating: 24V ±10%, approx. 12W

**■ GENERAL PRECAUTIONS**

- DO NOT set the switches while the power is supplied. The switches are used only for maintenance without the power.

**■ ENVIRONMENT**

- Indoor use.
- When heavy dust or metal particles are present in the air, install the unit inside proper housing with sufficient ventilation.
- Do not install the unit where it is subjected to continuous vibration. Do not subject the unit to physical impact.
- Environmental temperature must be within -10 to +55°C (14 to 131°F) with relative humidity within 30 to 90% RH in order to ensure adequate life span and operation.

**■ WIRING**

- Do not install cables (power supply, input and output) close to noise sources (relay drive cable, high frequency line, etc.).
- Do not bind these cables together with those in which noises are present. Do not install them in the same duct.

**■ AND ....**

- The unit is designed to function as soon as power is supplied, however, a warm up for 10 minutes is required for satisfying complete performance described in the data sheet.

**INSTALLATION**

Use the Installation Base Model R3-BS, or Model R3-BSW for free I/O address capability.

Before mounting the Network Interface Module onto the Base, be sure to configure the module as explained below.

**■ NODE ADDRESS**

See “COMPONENT IDENTIFICATION.”

**■ NETWORK SLOTS ON THE BASE**

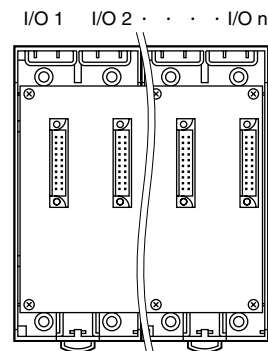

With Model R3-BS base, mount the I/O Modules without any space between them from the left end (I/O 1) to the right in order that the Network Module assigns data areas from I/O 1. If the I/O module 1 is not mounted, or there is any empty slot between the modules, communication error occurs.

Network Module(s) and Power Module are mounted basically at the right end though technically they could be mounted in any position.

With Model R3-BSW base, there is no limitation in mounting positions as I/O address can be assigned freely to each module using rotary switches equipped on the base.

## COMPONENT IDENTIFICATION

### FRONT VIEW

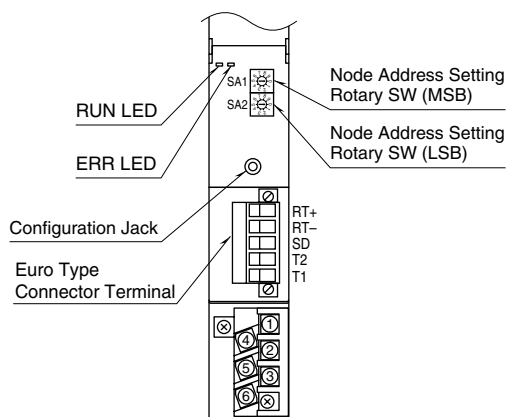

### FRONT ROTARY SW

#### • Node Address: SA1, SA2

Node Address is set in decimal.  
(Setpoint adjustment: 00 – 99)

### SIDE VIEW

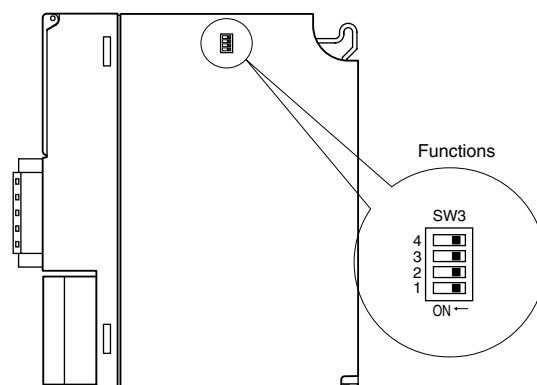

### SIDE DIP SW

(\*) Factory setting

#### • Dual Communication: SW3-1

When two network modules are mounted, one must be 'Main' (OFF) network and the other must be 'Sub' (ON) network. For single communication, the network module must always be set to 'Main' (OFF).

SW	DUAL COMMUNICATION	
	MAIN	SUB
SW3-1	OFF (*)	ON

#### • Input Error Data: SW3-2

Hold: When the communication from an input module is lost due to the input module error, the network module holds the signal and stands by until the communication recovers.

Set to '0': When the communication from an input module is lost due to the input module error, the network module outputs '0'.

SW	INPUT ERROR DATA	
	HOLD	SET '0'
SW3-2	OFF (*)	ON

#### • LED Function: SW3-4

Functions assigned to the front RUN and ERR LEDs can be selected.

SW3-4	LED FUNCTION	
	RUN	ERR
OFF(*)	Green when normal	Green ON or blinking when abnormal
ON	Red blinking when receiving	Red blinking when transmitting

Note: Be sure to set unused SW3-3 to OFF.

## PC CONFIGURATOR

With configurator software, settings shown below are available.  
Refer to the software manual of R3CON for detailed operation.

### NETWORK MODULE SETTING

PARAMETER	AVAILABLE RANGE	DEFAULT SETTING
Time (no communication time)	0.2 – 3200.0 (sec.)	3.0 (sec.)

## TERMINAL CONNECTIONS

Connect the unit as in the diagram below.

### EXTERNAL DIMENSIONS unit: mm (inch)

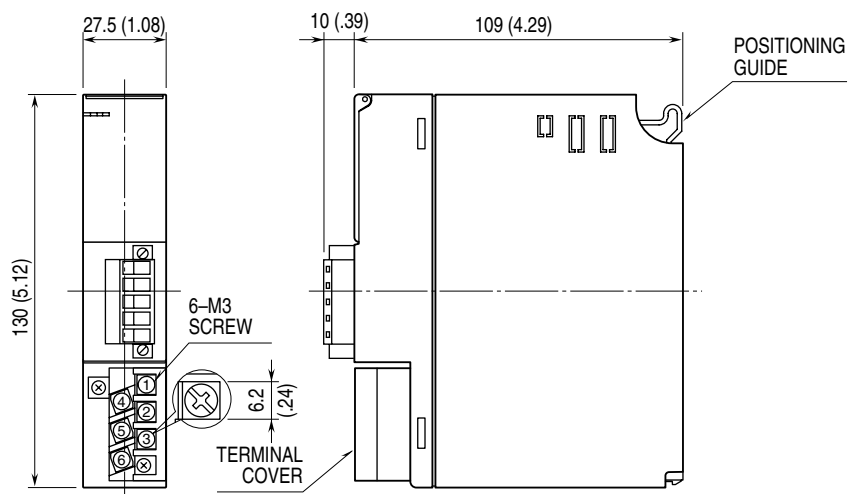

### CONNECTION DIAGRAM

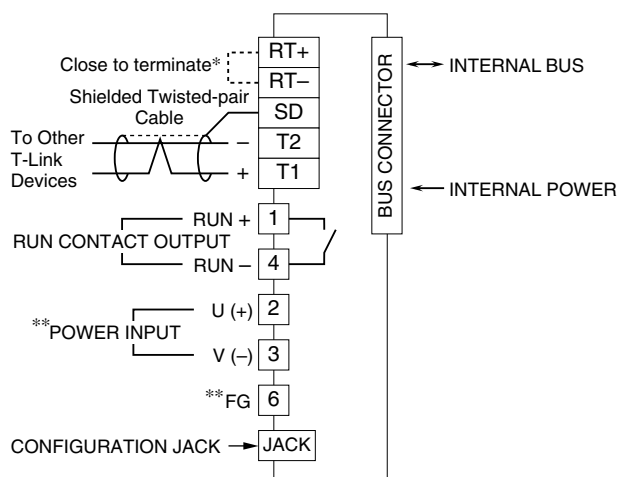

- \* When the module is at an end of the transmission line via twisted-pair cable (= when there is no cross wiring), close across the RT+ and RT- terminals with the jumper included in the product package. Remove the jumper for all other locations.  
 \*\*Not provided with 'No Power Supply' type module.  
 Caution: FG terminal is NOT a protective conductor terminal.

## WIRING INSTRUCTIONS

### M3 SCREW TERMINAL (power input, RUN contact output)

Torque: 0.5 N·m

### SOLDERLESS TERMINAL

Refer to the drawing below for recommended ring tongue terminal size. Spade tongue type is also applicable. Solderless terminals with insulation sleeve do not fit.

Recommended manufacturer: Japan Solderless Terminal MFG.Co.Ltd, Nichifu Co.,ltd

Applicable wire size: 0.75 to 1.25 mm<sup>2</sup>

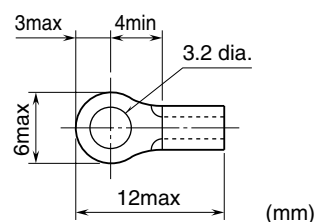

### EURO TYPE CONNECTOR TERMINAL (T-Link)

Applicable wire size: 0.2 to 2.5 mm<sup>2</sup> (AWG24 to 12)

Stripped length: 7 mm

## TRANSMISSION DATA DESCRIPTIONS

This module allocates T-link addresses in order from slot 1. Set the begin address to the module's node address (T-Link address.)

For example; if the formation of the I/O modules is: slot 1: R3-SV4, slot 2: R3-YV4, slot 3: R3-DA16 and slot 4: R3-DC16, the I/O data is assigned as detailed on the table below. Set "10" to the module address. Discrete I/O data can be also represented with bit address. Ch.1 through 16 are assigned to 0 thr. F.

SLOT	MODULE	ADDRESS	WORD ADDRESS	CONTENTS
1	R3-SV4	10	0	CH1 input data
			1	CH2 input data
			2	CH3 input data
			3	CH4 input data
2	R3-YV4	11	0	CH1 output data
			1	CH2 output data
			2	CH3 output data
			3	CH4 output data
3	R3-DA16	12	0	Input data
4	R3-DC16	13	0	Output data

## SYSTEM DEFINITIONS

### • Registration of R3-NF2

Specify as follows: Module type: Slave; Outline: T-Link i/f unit (FTL); T-link address: Node address (rotary sw.)

### • Registration of I/O module

Select "Remote I/O" for the type of module. Configure on the parameters the data size of the I/O modules. Refer to each module's data allocation area value for the data size setting; except for the modules detailed below, of which data size is not related to the allocation area value.

MODEL	TYPE	DATA SIZE (WORDS)	
		Input	Output
R3-DA32A, R3-Ax8	Digital input	2	0
R3-DC32x	Digital output	0	2
R3x-DAC16x, R3x-RR8, R3-PD16x	Digital input/output	1	1

## I/O DATA DESCRIPTIONS

The data allocations for typical I/O modules are shown below.  
Refer to the manual for each module for detailed data allocations.

### ■ ANALOG DATA (16-bit data, models: R3-SV4, YV4, DS4, YS4 and US4, etc.)

16-bit binary data.

Basically, 0 to 100% of the selected I/O range is converted into 0 to 10000 (binary).

-15 to 0 % is a negative range represented in 2's complement.

In case of R3-US4, -10 to 0% is a negative range represented in 2's complement.



### ■ TEMPERATURE DATA (16-bit data, models: R3-RS4, TS4 and US4, etc.)

16-bit binary data.

With °C temperature unit, raw data is multiplied by 10. For example, 25.5°C is converted into 255.

With °F temperature unit, the integer section of raw data is directly converted into the data. For example, 135.4°F is converted into 135.

Minus temperature is converted into negative values, represented in 2's complements.



### ■ ANALOG DATA (16-bit data, models: R3-CT4A, CT4B, etc.)

16-bit binary data.

Integer obtained by multiplying unit value (A) by 100.

In case of CLSE-R5, integer obtained by multiplying unit value (A) by 1000.



### ■ ACCUMULATED COUNT DATA (32-bit data, models: R3-PA2, PA4A, WT1, WT4, etc.)

32-bit binary data is used for accumulated counts and encoder positions.

Lower 16 bits are allocated from the lowest address to higher ones, higher 16 bits in turn.

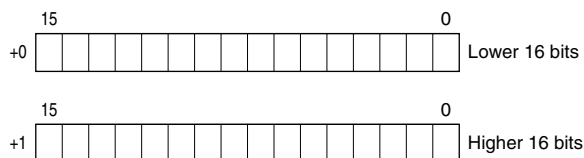

### ■ BCD DATA (32-bit data, models: R3-BA32A, BC32A, etc.)

32-bit binary data is used for BCD.

Lower 16 bits are allocated from the lowest address to higher ones, higher 16 bits in turn.



### ■ DISCRETE DATA (models: R3-DA16, DC16, etc.)

