

INSTALLATION BASE
(R3 I/O module extension use)

MODEL **R30EBS**

BEFORE USE

Thank you for choosing us. Before use, please check contents of the package you received as outlined below. If you have any problems or questions with the product, please contact our sales office or representatives.

■ PACKAGE INCLUDES:

- Installation base.....(1)
- Extension mounting brackets.....(2)

■ MODEL NO.

Confirm Model No. marking on the product to be exactly what you ordered.

■ INSTRUCTION MANUAL

This manual describes necessary points of caution when you use this product, including installation, connection and basic maintenance procedures.

POINTS OF CAUTION

■ GENERAL PRECAUTIONS

- Before you remove the unit or mount it, turn off the power supply, input and output signals for safety.

■ ENVIRONMENT

- Indoor use.
- When heavy dust or metal particles are present in the air, install the unit inside proper housing with sufficient ventilation.
- Do not install the unit where it is subjected to continuous vibration. Do not subject the unit to physical impact.
- Environmental temperature must be within -10 to +55°C (14 to 131°F) with relative humidity within 10 to 90% RH in order to ensure adequate life span and operation.

■ WIRING

- Do not install cables close to noise sources (relay drive cable, high frequency line, etc.).
- Do not bind these cables together with those in which noises are present. Do not install them in the same duct.

INSTALLATION

■ FRONT VIEW

The I/O slots are numbered in the ascending order starting from the one on the immediate right of the network module (slot 1, slot 2...).

A code indicating the I/O slot number is assigned to each I/O slot and I/O data is allocated in the order of this code.

When an I/O slot is vacant, blank data is sent or received to/from the PLC, etc.

Use in combination with R30BS. Mount the R3 I/O Modules from the left end (I/O 1) to the right.

PWR COM I/O 1 I/O n I/O 1 I/O 2 I/O n

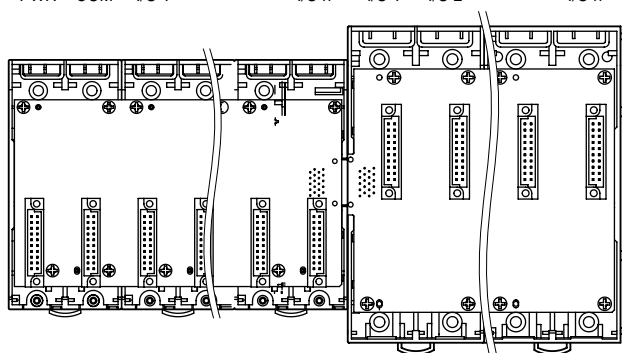

■ DIN RAIL MOUNTING

Set the unit such that its DIN rail adaptor is at the bottom. Hang the upper hook at the rear side of unit on the DIN rail and push in the lower. When removing the unit, push down the DIN rail adaptor utilizing minus screwdriver and pull.

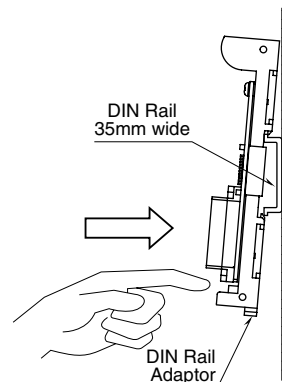

■ HOW TO ATTACH TO R30BS

Insert extension mounting brackets into R30EBS. Mount the R30EBS to R30BS by sliding the provided extension mounting brackets.

Note: DO NOT remove it. Removing by force may cause damage.

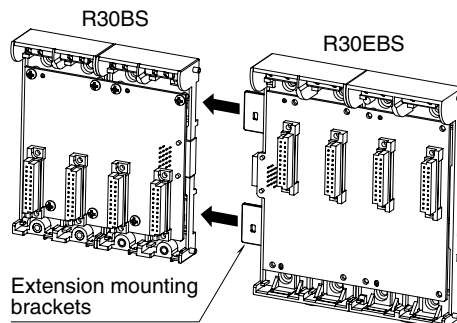

■ MOUNTING DIRECTION

The unit must be mounted on a vertical panel. Mounting in any other angle will cause internal temperature to rise, may shorten the product's life expectation or deteriorate its performance.

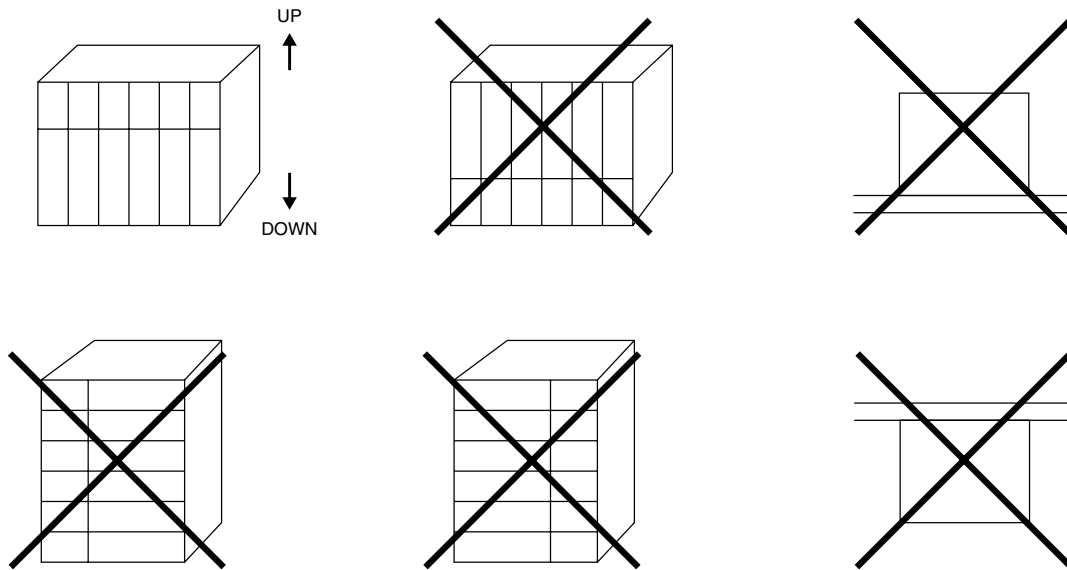

■ MOUNTING ON CONTROL PANEL

Secure sufficient ventilation space. Do not mount the unit right above devices which radiate great heat such as heaters, transformers or resistors. Maintenance space is also required above and below the unit.

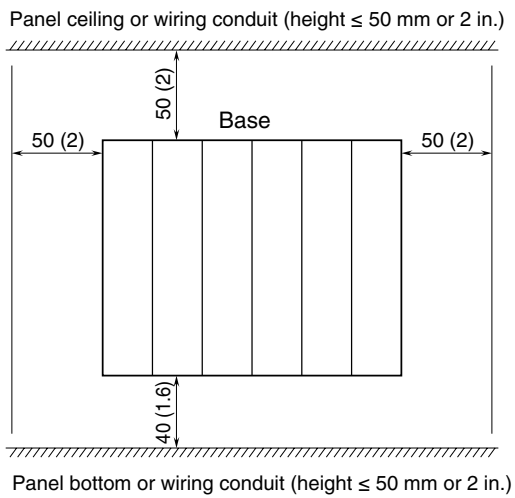

■ WALL MOUNTING unit: mm (inch)

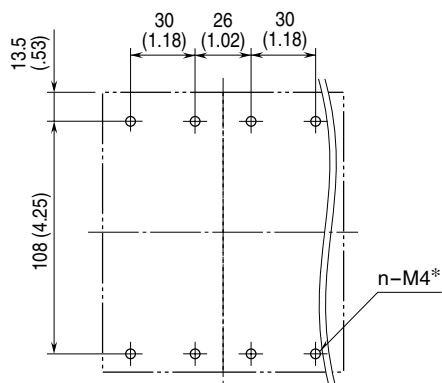

*n = Number of slots x 2

EXTERNAL DIMENSIONS unit: mm (inch)

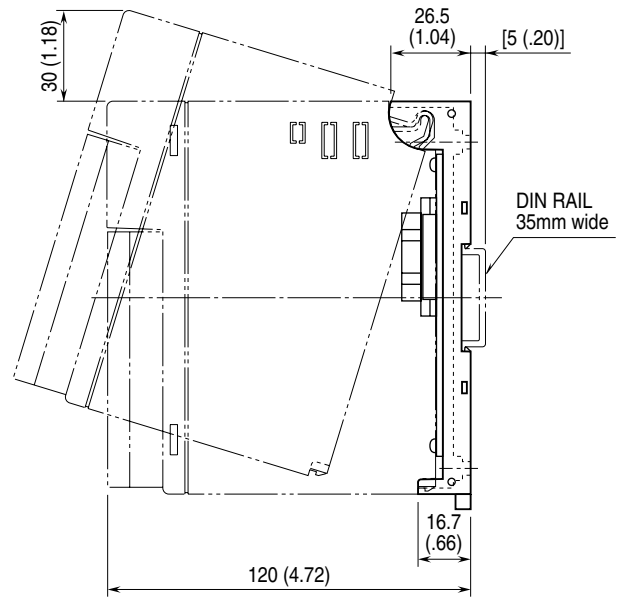
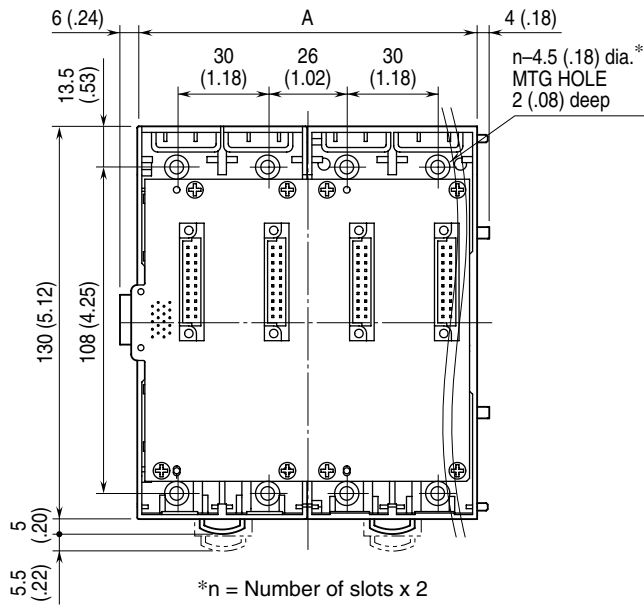

MODEL	A (SIZE)	n (NUMBER OF SCREWS)
R30EBS04	112	8
R30EBS08	224	16