

BEFORE USE

Thank you for choosing us. Before use, please check contents of the package you received as outlined below.

If you have any problems or questions with the product, please contact our sales office or representatives.

■ PACKAGE INCLUDES:

Network interface module(1)
Terminating resistor (110 Ω, 0.5 W).....(1)

■ MODEL NO.

Confirm Model No. marking on the product to be exactly what you ordered.

■ INSTRUCTION MANUAL

This manual describes necessary points of caution when you use this product, including installation, connection and basic maintenance procedures.

POINTS OF CAUTION**■ CONFORMITY WITH EU DIRECTIVES**

- The equipment must be mounted inside a panel.
- The actual installation environments such as panel configurations, connected devices, connected wires, may affect the protection level of this unit when it is integrated in a panel system. The user may have to review the CE requirements in regard to the whole system and employ additional protective measures to ensure the CE conformity.

■ HOT INSERTION/REMOVAL OF MODULES

- It is possible to replace the module with the power is supplied. Be sure to replace it when the module is not communicating with a host, as it is possible to affect the system. However, replacing multiple modules at once may greatly change line voltage levels. We recommend that you replace them one by one.

■ GENERAL PRECAUTIONS

- Do not set the DIP switch on the side panel while the power is supplied. The DIP switch is selectable for maintenance without the power.

■ ENVIRONMENT

- Indoor use.
- When heavy dust or metal particles are present in the air, install the unit inside proper housing with sufficient ventilation.
- Do not install the unit where it is subjected to continuous vibration. Do not subject the unit to physical impact.
- Environmental temperature must be within -10 to +55°C (14 to 131°F) with relative humidity within 30 to 90% RH in order to ensure adequate life span and operation.

■ WIRING

- Do not install cables close to noise sources (relay drive cable, high frequency line, etc.).
- Do not bind these cables together with those in which noises are present. Do not install them in the same duct.

■ AND

- The unit is designed to function as soon as power is supplied, however, a warm up for 10 minutes is required for satisfying complete performance described in the data sheet.

INSTALLATION

Use the Base Model R6x-BSA or R6x-BSB.

Before mounting the Network Interface Module onto the Base, be sure to configure the module as explained below.

■ DATA ALLOCATION

The setting determines the data area size assigned to each I/O module mounted on the base.

The data sent/received via CC-Link is mapped according to this setting.

In order to use the second channel of analog I/O modules, choose the Mode 2. (The 2nd channel cannot be sent/received in the Mode 1.)

See "COMPONENT IDENTIFICATION."

■ STATION No. & BAUD RATE

See "COMPONENT IDENTIFICATION."

■ NETWORK SLOTS ON THE BASE

Mount the Network Module to the dedicated slot on the base.

• R6x-BSA

The I/O and the power (model: R6x-PF1) modules can be positioned freely on whichever among the slots 1 through 8. Set a module address to each I/O module.

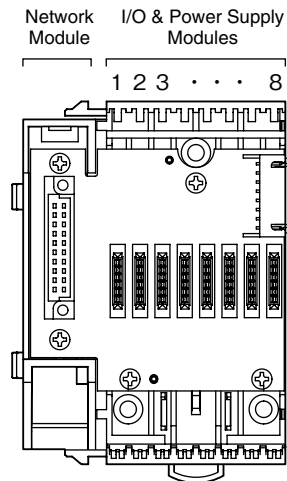

• R6x-BSB

The power module (model: R6-PSM) should be located on the extreme left, the I/O modules can be positioned freely on whichever among the slots 1 through 8. Set a module address to each I/O module.

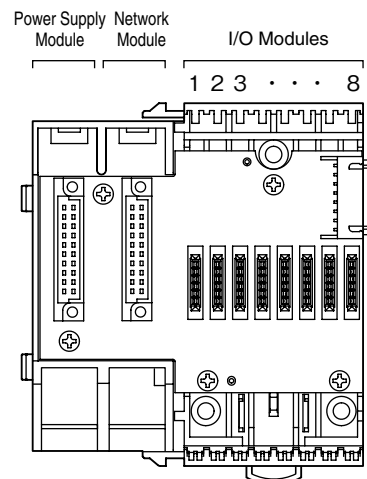

COMPONENT IDENTIFICATION

■ SIDE VIEW

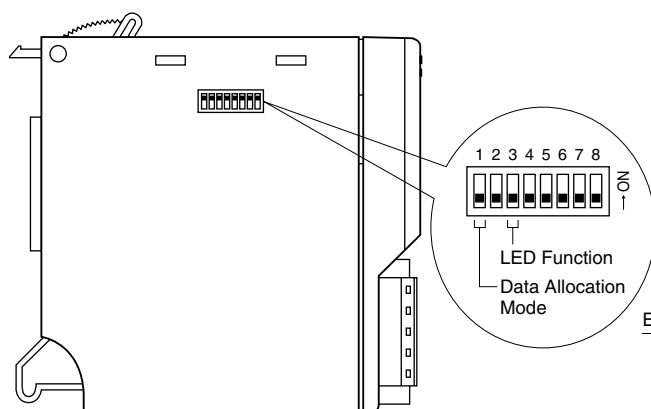

■ FRONT VIEW

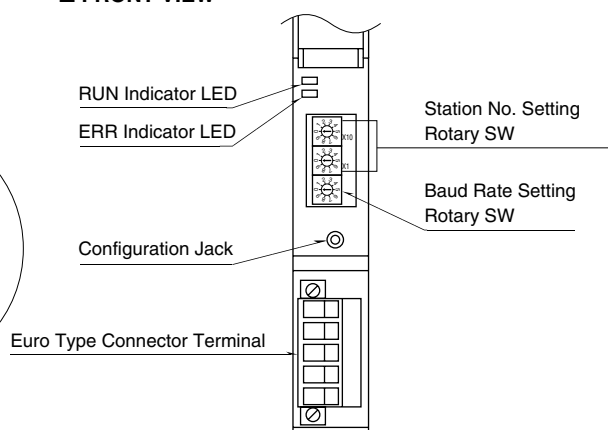

■ SIDE DIP SW

(*) Factory setting

• Data Allocation Mode: SW1

DATA ALLOCATION MODE	SW1
2 (2 words) (*)	
1 (1 word)	■

■ = ON, Blank = OFF

• LED Function: SW3

LED FUNCTION	SW3
RUN : Green ON in normal communications(*)	
ERR : Green ON / blinks in comm. errors(*)	
RUN : Red ON when receiving	
ERR : Red ON when transmitting	■

■ = ON, Blank = OFF

Note: Be sure to set unused SW2, SW5 through 8 to OFF.

■ FRONT ROTARY SW

• Station No.: SA1, SA2

Station No. is set in decimal.
(Setpoint adjustment: 01 – 64)

• Baud Rate

SW POSITION	BAUD RATE
0	156 kbps
1	625 kbps
2	2.5 Mbps
3	5 Mbps
4	10 Mbps
Other positions	Invalid; ERR LED ON

PC CONFIGURATOR

With configurator software, settings shown below are available.
Refer to the software manual of R6CON for detailed operation.

■ INTERFACE MODULE SETTING

PARAMETER	AVAILABLE RANGE	DEFAULT SETTING
Communication Failure Detection Time	0.2 – 3200.0 (sec.)	3.0 (sec.)
Card map	00000000 to FFFFFFFF	FFFFFFF

TERMINAL CONNECTIONS

Connect the unit as in the diagram below.

EXTERNAL DIMENSIONS unit : mm (inch)

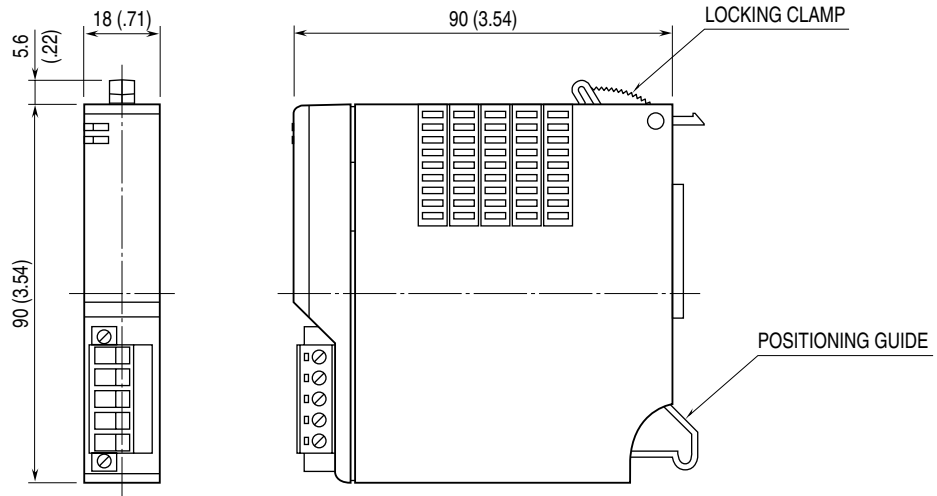

CONNECTION DIAGRAM

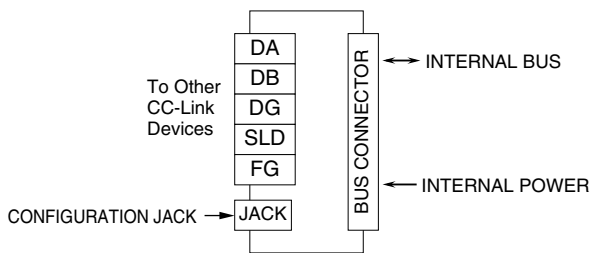

Note: The FG terminal is not connected with the FG of the power supply module (Model: R6x-PF1 or R6-PSM).

WIRING INSTRUCTIONS

EURO TYPE CONNECTOR TERMINAL (CC-Link)

Applicable wire size: 0.2 – 2.5 mm² (AWG24 – 12)

Stripped length: 7 mm

COMMUNICATION CABLE CONNECTION

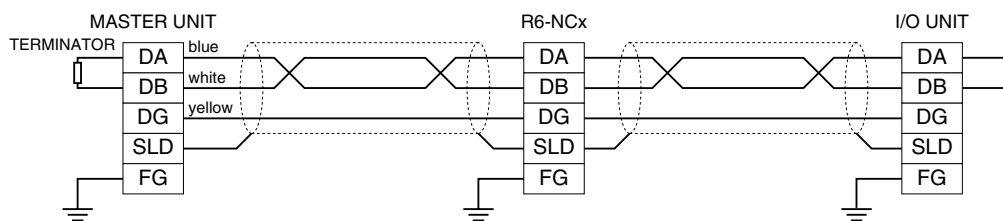

TRANSMISSION DATA DESCRIPTIONS

The DIP SW located at the side of the module switches the unit's data allocation mode.

In the Data Allocation Mode 1, one (1) word is assigned per module. The second channel of analog I/O modules cannot be used. Max. 16 I/O modules can be connected in this mode.

In the Data Allocation Mode 2, two (2) words are assigned per module regardless of whether the second word area is required or not, even for discrete I/O modules (Mode 1).

Max. 8 I/O modules can be connected in this mode.

■ DATA ALLOCATION MODE 1

• Output Data

The figure below shows the allocation of data sent from the network module to the master.

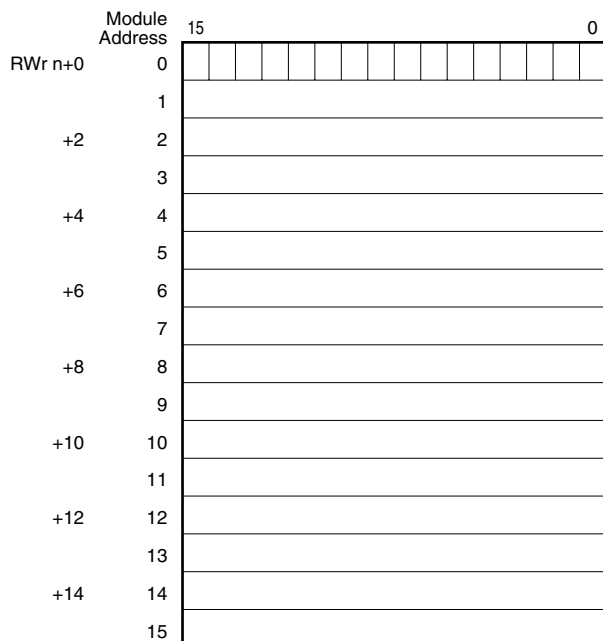

• Input Data

The figure below shows the allocation of data sent from the master to the network module.

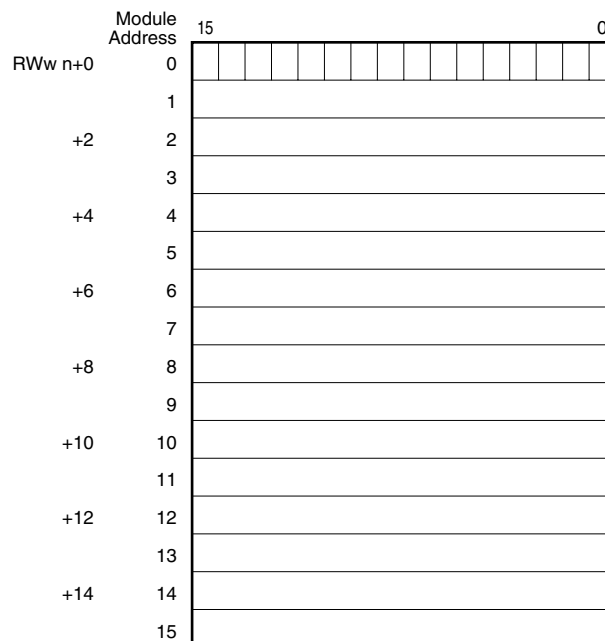

Each module takes one-word areas for input and output respectively, regardless of whether the module type is input or output. If a module for Data Allocation Mode 2 is used, the second channel data is invalid.

Field input data is set in the module's output data area. The input data area is also secured though not used for an input module.

• RX(n+0)0 through RX(n+0)F

RX(n+0)0 through RX(n+0)F show the I/O module's data error.

- Input overrange ($\leq -15\%$ or $\geq 115\%$) of Input modules except R6x-TS2 and R6x-RS2.
- Inputs of R6x-TS2, R6x-RS2 burnout.
- Output wire breakdown of R6x-YS2 (Firmware Version 2.00 or later). *1

In the above case, the corresponded bit is "1."

Also the corresponded bit for unmounted channels is "1."

RX(n+0) 0	Module address 0
RX(n+0) 1	Module address 1
RX(n+0) 2	Module address 2
RX(n+0) 3	Module address 3
:	:
:	:
RX(n+0) E	Module address 14
RX(n+0) F	Module address 15

• RX(n+1)0 through RX(n+1)F

RX(n+1)0 through RX(n+1)7 are reserved for future use. RX(n+1)8 through RX(n+1)A and RX(n+1)C through RX(n+1)F are not used, while RX(n+1)B is assigned to Ready signal, which is turned to "1" when the network module is in normal conditions.

*1. R6-NC1 is compatible with Firmware version 1.02 or later.

■ DATA ALLOCATION MODE 2

• Output Data

The figure below shows the allocation of data sent from the network module to the master.

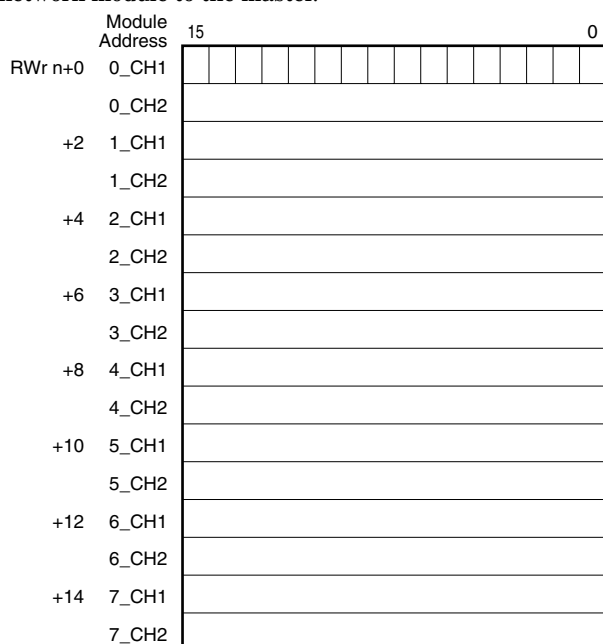

• Input Data

The figure below shows the allocation of data sent from the master to the network module.

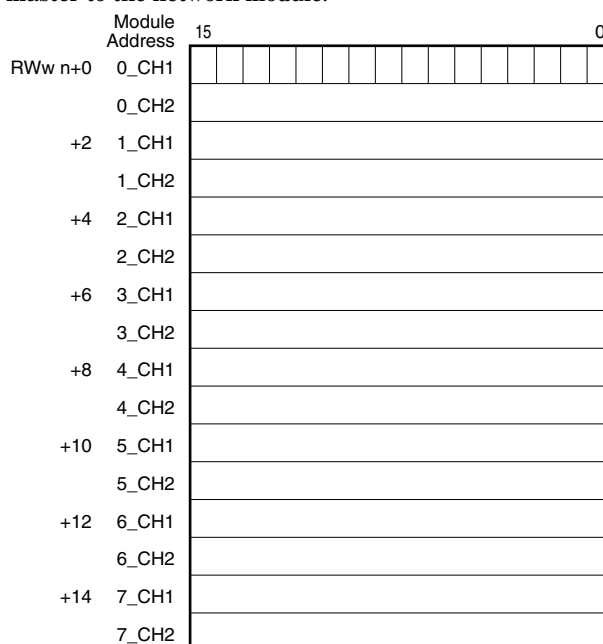

Each module takes two-word areas for input and output respectively, regardless of whether the module type is input or output. If a module for Data Allocation Mode 1 is used, all the bits for the second channel data turn to "0" (unused).

Field input data is set at the module's output data area. The input data area is also secured though not used for an input module.

• RX(n+0)0 through RX(n+0)F

RX(n+0)0 through RX(n+0)F show the I/O module's data error.

- Input overrange ($\leq -15\%$ or $\geq 115\%$) of Input modules except R6x-TS2 and R6x-RS2.
- Inputs of R6x-TS2, R6x-RS2 burnout.
- Output wire breakdown of R6x-YS2 (Firmware Version 2.00 or later). *2

In the above case, the corresponded bit is "1."

The allocation using R6-NC1 with modules all of which data allocation is "2" is shown below.

RX(n+0) 0	Module address 0, I/O 1
RX(n+0) 1	Module address 0, I/O 2
RX(n+0) 2	Module address 1, I/O 1
RX(n+0) 3	Module address 1, I/O 2
:	:
:	:
RX(n+0) E	Module address 7, I/O 1
RX(n+0) F	Module address 7, I/O 2

• RX(n+1)0 through RX(n+1)F

RX(n+1)0 through RX(n+1)7 are reserved for future use. RX(n+1)8 through RX(n+1)A and RX(n+1)C through RX(n+1)F are not used, while RX(n+1)B is assigned to Ready signal, which is turned to "1" when the network module is in normal conditions.

*2. R6-NC1 is compatible with Firmware version 1.02 or later.

I/O DATA DESCRIPTIONS

• 16-bit Analog Data

0 to 100% of the selected I/O range is converted into 0 to 10000 (binary).

With °C temperature unit, raw data is multiplied by 10. For example, 25.5°C is converted into 255.

With °F temperature unit, the integer section of raw data is directly converted into the data. For example, 135.4°F is converted into 135.

Negative values are represented in 2's complements.



• Discrete Data

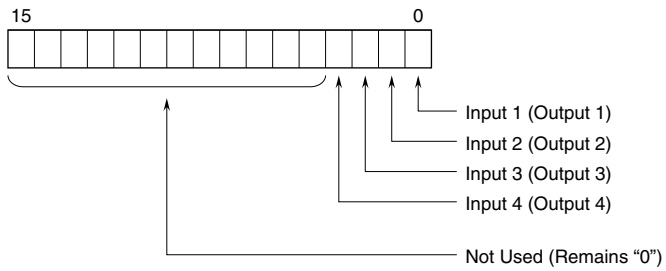

0 : OFF
1 : ON