

<p>4 – 20mA INPUT MODULE (2-wire transmitter excitation supply, Screw terminal)</p>	<p>MODEL R6N-DS1</p>
---	-----------------------------

BEFORE USE

Thank you for choosing us. Before use, please check contents of the package you received as outlined below. If you have any problems or questions with the product, please contact our sales office or representatives.

■ PACKAGE INCLUDES:

4 – 20mA input module.....(1)

■ MODEL NO.

Confirm Model No. marking on the product to be exactly what you ordered.

■ INSTRUCTION MANUAL

This manual describes necessary points of caution when you use this product, including installation, connection and basic maintenance procedures.

The unit is programmable using the PC Configurator Software. For detailed information on the PC configuration, refer to the R6CON users manual. The R6CON PC Configurator Software is downloadable at our web site.

POINTS OF CAUTION

■ CONFORMITY WITH EU DIRECTIVES

- The equipment must be mounted inside a panel.
- The actual installation environments such as panel configurations, connected devices, connected wires, may affect the protection level of this unit when it is integrated in a panel system. The user may have to review the CE requirements in regard to the whole system and employ additional protective measures to ensure the CE conformity.
- Install lightning surge protectors for those wires connected to remote locations.

■ HOT INSERTION/REMOVAL OF MODULES

- Removing or replacing modules does not affect other modules on the same backplane. It is possible to replace them without removing the power supply. However, replacing multiple modules at once may greatly change line voltage levels. We recommend that you replace them one by one.

■ GENERAL PRECAUTIONS

- Do NOT set the switches while the power is supplied. The switches are used only for maintenance without the power.

■ ENVIRONMENT

- Indoor use.
- When heavy dust or metal particles are present in the air, install the unit inside proper housing with sufficient ventilation.
- Do not install the unit where it is subjected to continuous vibration. Do not subject the unit to physical impact.

- Environmental temperature must be within -10 to +55°C (14 to 131°F) with relative humidity within 30 to 90% RH in order to ensure adequate life span and operation.

■ WIRING

- Do not install cables close to noise sources (relay drive cable, high frequency line, etc.).
- Do not bind these cables together with those in which noises are present. Do not install them in the same duct.

■ AND

- The unit is designed to function as soon as power is supplied, however, a warm up for 10 minutes is required for satisfying complete performance described in the data sheet.

COMPONENT IDENTIFICATION

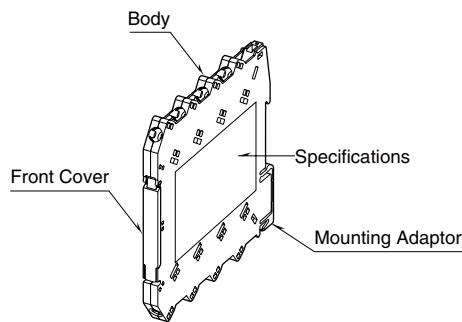

INSTALLATION

Mount the unit on the base (model: R6N-BS).

EXTERNAL VIEWS

• Front View (cover opened)

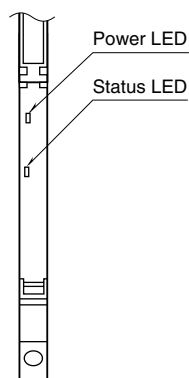

• Side View

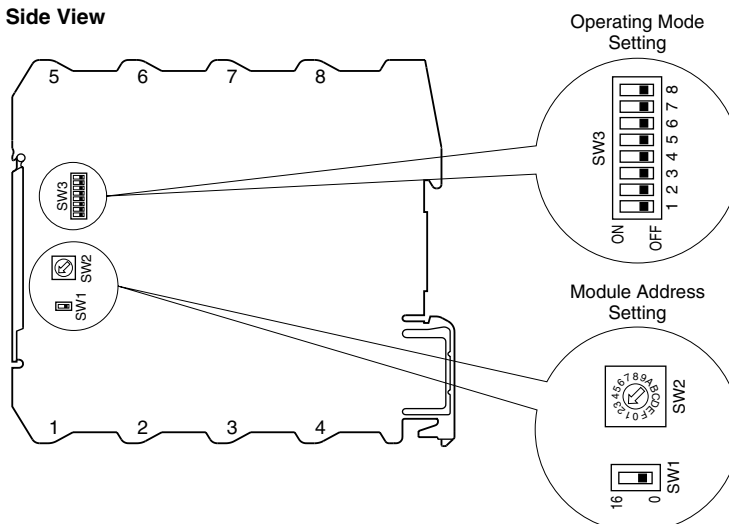

Operating Mode Setting

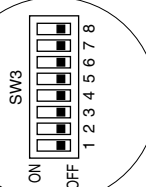

Module Address Setting

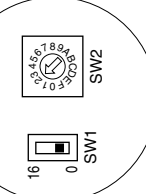

■ INDICATOR LED

ID	COLOR	FUNCTION
Power	OFF	Power supply is off
	Green ON	Power supply is on.
Status	OFF	Standing by (at the startup) or communication error
	Green ON	Normal communication
	Green blink	Configuration mode
	Red ON	DIP switch error
	Red blink 2 sec. interval	Parameter error
	Red blink 0.5 sec. interval	Analog input range error ($\leq -15\%$ or $\geq 115\%$)

■ OPERATING MODE

• Configuration Mode

CONFIGURATION MODE	SW3-8
DIP SW (*)	
PC	■

■ = ON, Blank = OFF

(*) Factory setting

Note: Be sure to set unused SW3-1 through 3-7 to OFF.

■ MODULE ADDRESS

Module address is selectable between 0 and 31. Choose 0 or 16 with SW1 for offsetting the address selected with SW2 (0 to F, hexadecimal).

The module's slot position on the base and the module address are not necessarily correlated.

ADDRESS	SW1	SW2	ADDRESS	SW1	SW2
0	0	0	16	16	0
1	0	1	17	16	1
2	0	2	18	16	2
3	0	3	19	16	3
4	0	4	20	16	4
5	0	5	21	16	5
6	0	6	22	16	6
7	0	7	23	16	7
8	0	8	24	16	8
9	0	9	25	16	9
10	0	A	26	16	A
11	0	B	27	16	B
12	0	C	28	16	C
13	0	D	29	16	D
14	0	E	30	16	E
15	0	F	31	16	F

TERMINAL CONNECTIONS

Connect the unit as in the diagram below or refer to the connection diagram on the side of the unit.

EXTERNAL DIMENSIONS unit: mm (inch)

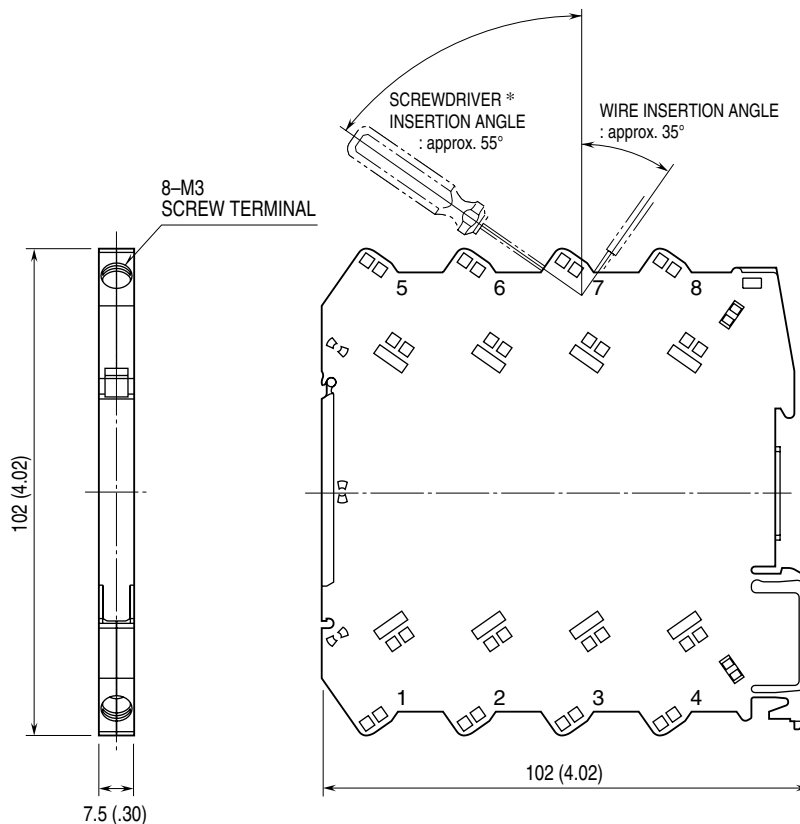

*Screwdriver stem diameter: 6 mm (.24") or less

CONNECTION DIAGRAM

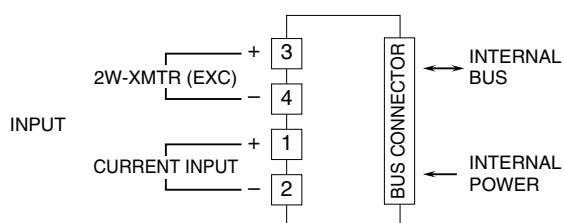

WIRING INSTRUCTIONS

SCREW TERMINAL

Torque: 0.5 N·m

SOLDERLESS TERMINAL unit: mm (inch)

Refer to the drawing below for recommended ring tongue terminal size. Spade tongue type is also applicable. Solderless terminals with insulation sleeve do not fit. Applicable wire size: 0.2 – 2.5 mm²

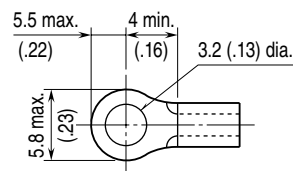

PC CONFIGURATOR

With configurator software, settings shown below are available.
Refer to the software manual of R6CON for detailed operation.

■ CHANNEL INDIVIDUAL SETTING

PARAMETER	AVAILABLE RANGE	DEFAULT SETTING
Lower range value	4.00 – 20.00 (mA)	4.00 (mA)
Upper range value	4.00 – 20.00 (mA)	20.00 (mA)
Fine zero adjustment	-320.00 to +320.00 (%)	0.00 (%)
Fine gain adjustment	-3.2000 to +3.2000	1.0000
Scaled range Zero	-32000 to +32000	0
Scaled range Span	-32000 to +32000	10000

■ CHANNEL BATCH SETTING

PARAMETER	AVAILABLE RANGE	DEFAULT SETTING
Loss of internal bus communication detection time	0.0 – 99.9 (sec.)	1.0 (sec.)
Conversion rate	10, 20, 40, 80 (msec.)	80 (msec.)