

T-Link INTERFACE MODULE
(Fuji Electric T-Link use)

MODEL **R6-NF1**

BEFORE USE

Thank you for choosing us. Before use, please check contents of the package you received as outlined below.

If you have any problems or questions with the product, please contact our sales office or representatives.

■ **PACKAGE INCLUDES:**

Network interface module(1)

■ **MODEL NO.**

Confirm Model No. marking on the product to be exactly what you ordered.

■ **INSTRUCTION MANUAL**

This manual describes necessary points of caution when you use this product, including installation, connection and basic maintenance procedures.

POINTS OF CAUTION

■ **HOT INSERTION/REMOVAL OF MODULES**

- It is possible to replace the module with the power is supplied. Be sure to replace it when the module is not communicating with a host, as it is possible to affect the system. However, replacing multiple modules at once may greatly change line voltage levels. We recommend that you replace them one by one.

■ **GENERAL PRECAUTIONS**

- Do not set the DIP switch on the side panel while the power is supplied. The DIP switch is selectable for maintenance without the power.

■ **ENVIRONMENT**

- Indoor use.
- When heavy dust or metal particles are present in the air, install the unit inside proper housing with sufficient ventilation.
- Do not install the unit where it is subjected to continuous vibration. Do not subject the unit to physical impact.
- Environmental temperature must be within -10 to +55°C (14 to 131°F) with relative humidity within 30 to 90% RH in order to ensure adequate life span and operation.

■ **WIRING**

- Do not install cables close to noise sources (relay drive cable, high frequency line, etc.).
- Do not bind these cables together with those in which noises are present. Do not install them in the same duct.

■ **AND**

- The unit is designed to function as soon as power is supplied, however, a warm up for 10 minutes is required for satisfying complete performance described in the data sheet.

INSTALLATION

Use the Base Model R6x-BSB.

Before mounting the Network Interface Module onto the Base, be sure to configure the module as explained below.

■ **DATA ALLOCATION**

The setting determines the data area size assigned to each I/O module mounted on the base.

The data sent/received via T-Link is mapped according to this setting.

In order to use the second channel of analog I/O modules, choose the Mode 2. (The 2nd channel cannot be sent/received in the Mode 1.)

See "COMPONENT IDENTIFICATION."

■ **STATION No., I/O POINTS & I/O TYPE**

See "COMPONENT IDENTIFICATION."

■ **MOUNTING ON THE BASE**

This module must be mounted on the slot for Network Module. I/O modules and Power Supply Module (model: R6x-PF1) are mountable on any slots.

Set Module address of each module regardless of its slot number.

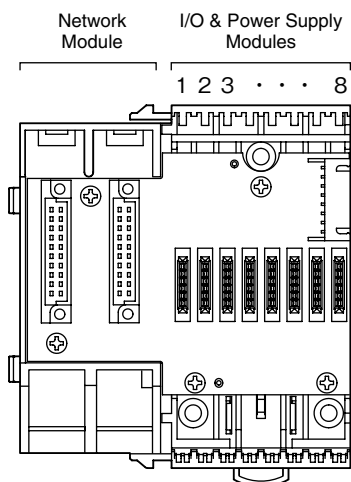

COMPONENT IDENTIFICATION

■ SIDE VIEW

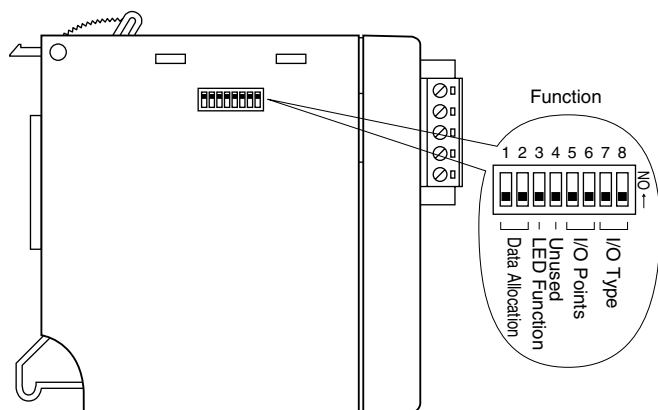

■ FRONT VIEW

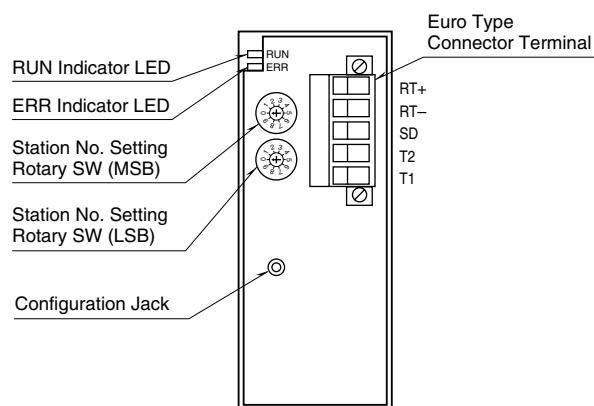

■ SIDE DIP SW

(*) Factory setting

• Data Allocation Mode: SW1, SW2

DATA ALLOCATION MODE	SW1	SW2
1	■	
2 (*)		

■ = ON, Blank = OFF

• LED Function: SW3

LED FUNCTION	SW3
RUN: Green ON in normal communications (*)	
ERR: Green ON/blinks in an abnormality	
RUN: Red ON when receiving	■
ERR: Red ON when transmitting	

■ = ON, Blank = OFF

• I/O Points: SW5, SW6

I/O POINTS	SW	
	5	6
64 points (64 words) (*)		
16 points (16 words)	■	
8 points (8 words)		■
4 points (4 words)	■	■

■ = ON, Blank = OFF

• I/O Type: SW7, SW8

I/O TYPE	SW	
	7	8
Input/Output Mixed (*)		
Output only	■	
Input only		■

■ = ON, Blank = OFF

Note: Be sure to set unused SW4 to OFF.

■ FRONT ROTARY SW

• Station No.

Station No. is set in decimal.
(Setpoint adjustment: 00 – 99)

PC CONFIGURATOR

With configurator software, settings shown below are available.
Refer to the software manual of R6CON for detailed operation.

■ INTERFACE MODULE SETTING

PARAMETER	AVAILABLE RANGE	DEFAULT SETTING
Communication Failure Detection Time	0.2 – 3200.0 (sec.)	3.0 (sec.)
Card map	00000000 to FFFFFFFF	FFFFFFF

TERMINAL CONNECTIONS

Connect the unit as in the diagram below.

EXTERNAL DIMENSIONS unit : mm (inch)

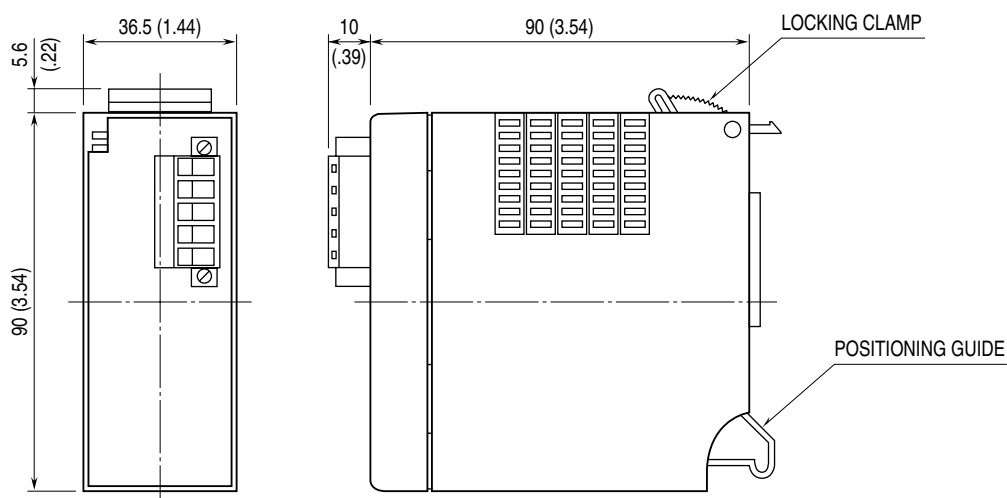

CONNECTION DIAGRAM

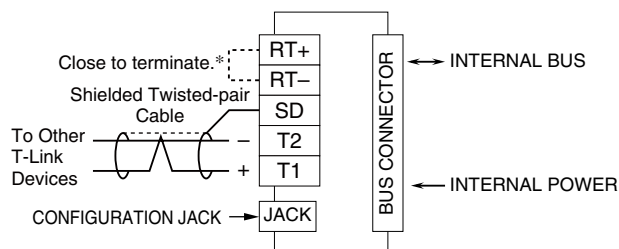

* When the module is at an end of the transmission line via twisted-pair cable (= when there is no cross wiring), close across the RT+ and RT- terminals with the jumper included in the product package. Remove the jumper for all other locations.

WIRING INSTRUCTIONS

EURO TYPE CONNECTOR TERMINAL (T-Link)

Applicable wire size: 0.2 – 2.5 mm² (AWG24 – 12)

Stripped length: 7 mm

TRANSMISSION DATA DESCRIPTIONS

The DIP SW located at the side of the module switches the unit's data allocation mode.

In the Data Allocation Mode 1, one (1) word is assigned for one I/O module. In this mode, analog I/O modules are used as single-channel types. Therefore, the second channel on the dual-channel modules cannot be used. The maximum number of modules connected to the network is 32.

In the Data Allocation Mode 2, two (2) words are assigned for one I/O module regardless of whether the second word area is required or not.

■ Data Allocation Mode 1

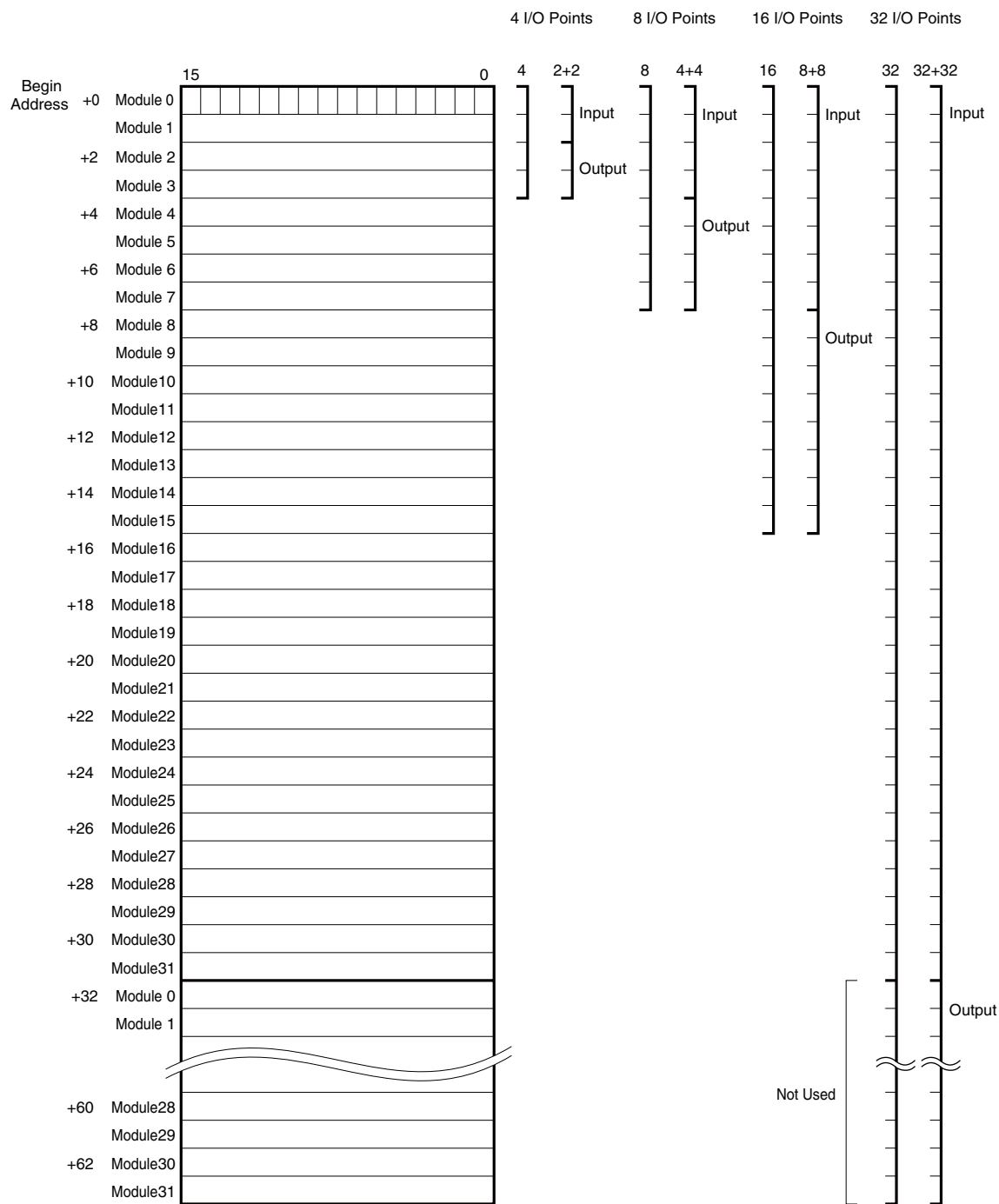

Assigned I/O Points	No. of Modules	Input Modules Only	Output Modules Only	I/O Modules Mixed
4	4	4	4	2 + 2
8	8	8	8	4 + 4
16	16	16	16	8 + 8
64	32	32	32	32 + 32

The number of assigned I/O points is the same as the number of modules, except 64 points. Modules of the number of I/O Points preset with SW5 and 6 are assigned to the transmission data continuously from zero (0). When I/O signals are to be mixed, the former half addresses are assigned to the inputs and the latter half are to the outputs. For example, if you have selected '8' I/O points and 'mixed' I/O type, the input modules must be assigned to Module address 0 through 3, and the output modules must be assigned to 4 through 7. When the number of I/O points is '64' and I/O type is NOT mixed, 32 points of the latter half are not used. However, the PLC requires 64 addresses. When the number of I/O points is '64' and I/O type is mixed, the former half 32 addresses are assigned to inputs and the latter half are to outputs. Only this assignment does not require continuous module addresses. However, the total number of modules is limited to 32.

■ Data Allocation Mode 2

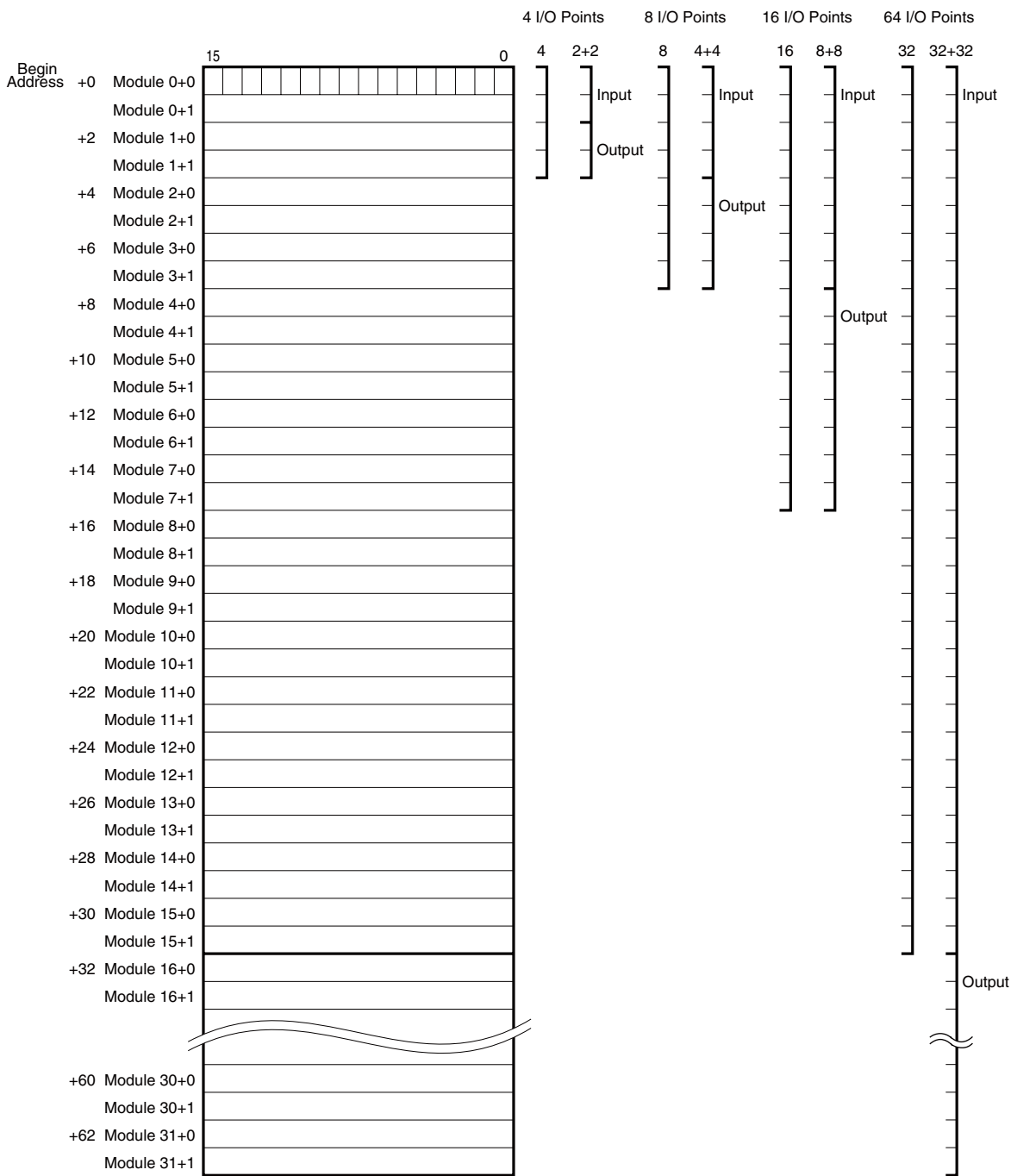

Assigned I/O Points	No. of Modules	Input Modules Only	Output Modules Only	I/O Modules Mixed
4	2	4	4	2 + 2
8	4	8	8	4 + 4
16	8	16	16	8 + 8
64	32	64	64	32 + 32

The number of assigned I/O points is the same as the doubled number of modules. Modules of the number of I/O Points preset with SW5 and 6 are assigned to the transmission data continuously from zero (0). When I/O signals are to be mixed, the former half addresses are assigned to the inputs and the latter half are to the outputs. For example, if you have selected '8' I/O points and 'mixed' I/O type, the input modules must be assigned to Module address 0 and 1, and the output modules must be assigned to 2 and 3.

I/O DATA DESCRIPTIONS

• 16-bit Analog Data

0 to 100% of the selected I/O range is converted into 0 to 10000 (binary).

With °C temperature unit, raw data is multiplied by 10. For example, 25.5°C is converted into 255.

With °F temperature unit, the integer section of raw data is directly converted into the data. For example, 135.4°F is converted into 135.

Negative values are represented in 2's complements.



• Discrete Data

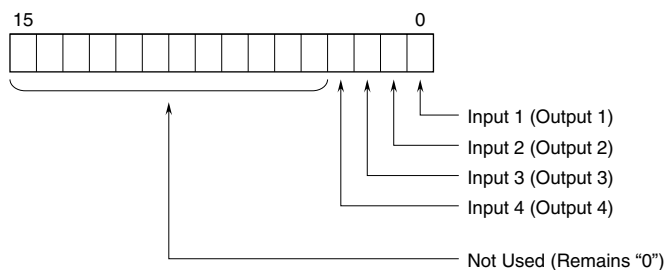

0 : OFF
1 : ON