

BEFORE USE

Thank you for choosing us. Before use, please check contents of the package you received as outlined below.

If you have any problems or questions with the product, please contact our sales office or representatives.

■ PACKAGE INCLUDES:

Discrete output module.....(1)

■ MODEL NO.

Confirm Model No. marking on the product to be exactly what you ordered.

■ INSTRUCTION MANUAL

This manual describes necessary points of caution when you use this product, including installation, connection and basic maintenance procedures.

■ EDS FILE

EDS files are downloadable at our web site.

POINTS OF CAUTION**■ CONFORMITY WITH EU DIRECTIVES**

- The equipment must be mounted inside the instrument panel of a metal enclosure.
- The actual installation environments such as panel configurations, connected devices, connected wires, may affect the protection level of this unit when it is integrated in a panel system. The user may have to review the CE requirements in regard to the whole system and employ additional protective measures* to ensure the CE conformity.

* For example, installation of noise filters and clamp filters for the power source, input and output connected to the unit, etc.

■ GENERAL PRECAUTIONS

- Before you remove the unit or mount it, turn off the power supply and output signal for safety.
- Before you remove the terminal block or mount it, make sure to turn off the power supply and output signal for safety.
- DO NOT set the switches on the module while the power is supplied. The switches are used only for maintenance without the power.

■ ENVIRONMENT

- Indoor use.
- When heavy dust or metal particles are present in the air, install the unit inside proper housing with sufficient ventilation.
- Do not install the unit where it is subjected to continuous vibration. Do not subject the unit to physical impact.
- Environmental temperature must be within -10 to +55°C (14 to 131°F) with relative humidity within 30 to 90% RH in order to ensure adequate life span and operation.

■ WIRING

- Do not install cables close to noise sources (relay drive cable, high frequency line, etc.).
- Do not bind these cables together with those in which noises are present. Do not install them in the same duct.
- Be sure to close the terminal cover for safety.

■ AND

- The unit is designed to function as soon as power is supplied, however, a warm up for 10 minutes is required for satisfying complete performance described in the data sheet.

COMPONENT IDENTIFICATION

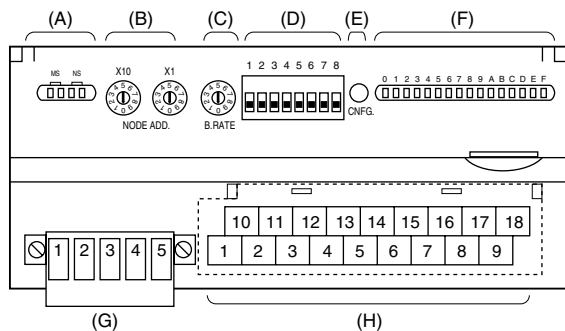

- (A) Status Indicator LED
- (B) Node Address Setting Rotary SW
- (C) Baud Rate Setting Rotary SW
- (D) Operating Mode Setting DIP SW (SW1)
- (E) PC Configurator Jack
- (F) Discrete Output Status Indicator LED
- (G) DeviceNet, Power Supply Terminals
- (H) Output Terminals

STATUS INDICATOR LED

ID	STATE	TO INDICATE
MS	Green	Operating in a normal condition
	Blinking Green	Standby (needs commissioning)
	Red	Critical failure
	Blinking Red	Minor failure
	OFF	No power supplied
NS	Green	Link on-line and connections in the established state
	Blinking Green	Link on-line but no connections in the established state
	Red	Critical link failure
	Blinking Red	Minor link failure
	OFF	No power supplied

DISCRETE OUTPUT STATUS INDICATOR LED

LED red indicators show the signal status.

- ON : LED ON
- OFF : LED OFF

NODE ADDRESS

Node Address is selected between 1 and 63 in decimal. The left switch determines the tenth place digit, while the right switch does the ones place digit of the address.

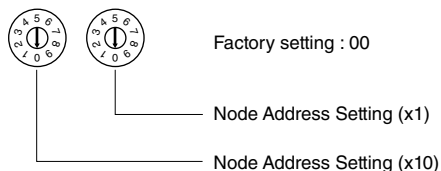

BAUD RATE

Baud Rate is selected with the rotary switch.

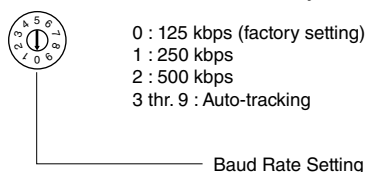

The R7D communicates in the baud rate setting detected at the startup with the switch set to the positions 0 (125 kbps), 1 (250 kbps) or 2 (500 kbps).

For the settings 3 through 9, it analyzes the PLC's network to determine the baud rate on the network.

OPERATING MODE

(*) Factory setting

Extension: SW1-1, 1-2

SW1-1	SW1-2	EXTENSION
OFF	OFF	No extension (*)
ON	OFF	Discrete input, 8 or 16 points
OFF	ON	Discrete output, 8 or 16 points

Output at the Loss of Communication: SW1-4

SW1-4	OUTPUT AT THE LOSS OF COMMUNICATION
OFF	Reset the output (turned off)
ON	Hold the output (*) (maintains the last data received normally)

Note: Be sure to set unused SW1-3 and 1-5 through 1-8 to OFF.

DeviceNet TERMINAL ASSIGNMENT

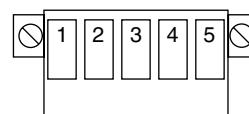

NO.	ID	FUNCTION, NOTES
1	V+	Network power supply +
2	CAN_H	Network data High
3	Drain	Shield
4	CAN_L	Network data Low
5	V-	Network power supply -

OUTPUT TERMINAL ASSIGNMENT

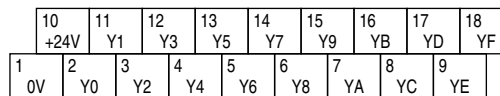

NO.	ID	FUNCTION	NO.	ID	FUNCTION
1	0V	0V	10	+24V	24V DC (common)
2	Y0	Output 0	11	Y1	Output 1
3	Y2	Output 2	12	Y3	Output 3
4	Y4	Output 4	13	Y5	Output 5
5	Y6	Output 6	14	Y7	Output 7
6	Y8	Output 8	15	Y9	Output 9
7	YA	Output 10	16	YB	Output 11
8	YC	Output 12	17	YD	Output 13
9	YE	Output 14	18	YF	Output 15

EXTENSION MODULE

Combinations with all extension modules are selectable.

■ CONNECTION DIAGRAM

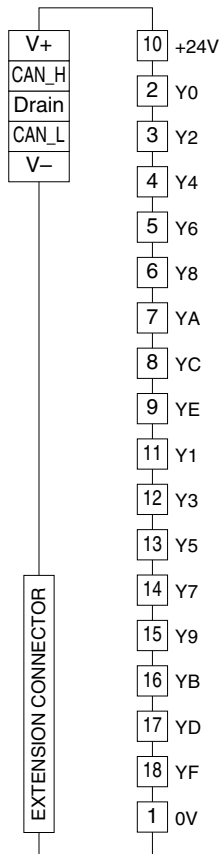

■ Output Connection Example

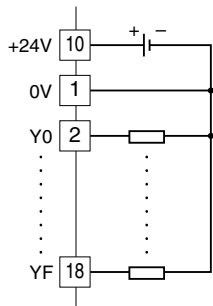

DATA ALLOCATION

'Begin' address is determined by the R7D's node address and the master setting.

- Example. R7D-DC16x + R7D-EC16x, with Status

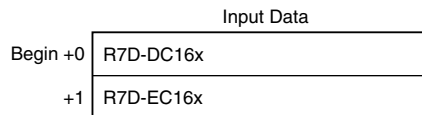
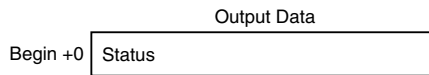

I/O DATA DESCRIPTIONS

■ DISCRETE I/O

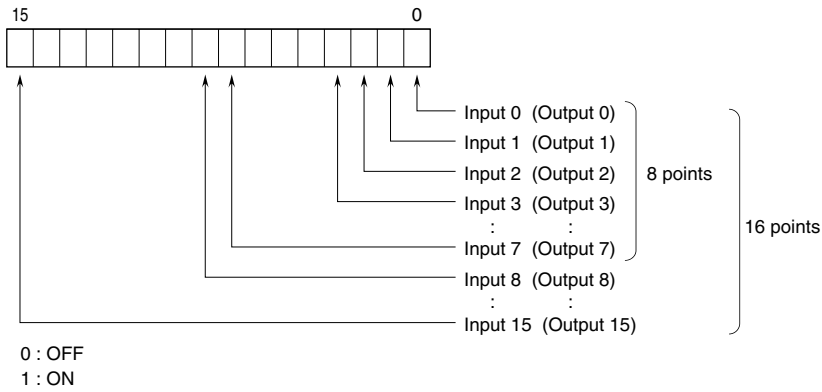

■ STATUS

Bit 0 to 7: Discrete output module shows '0' at the same address.

Bit 8 to 10: Shows the power supply status.

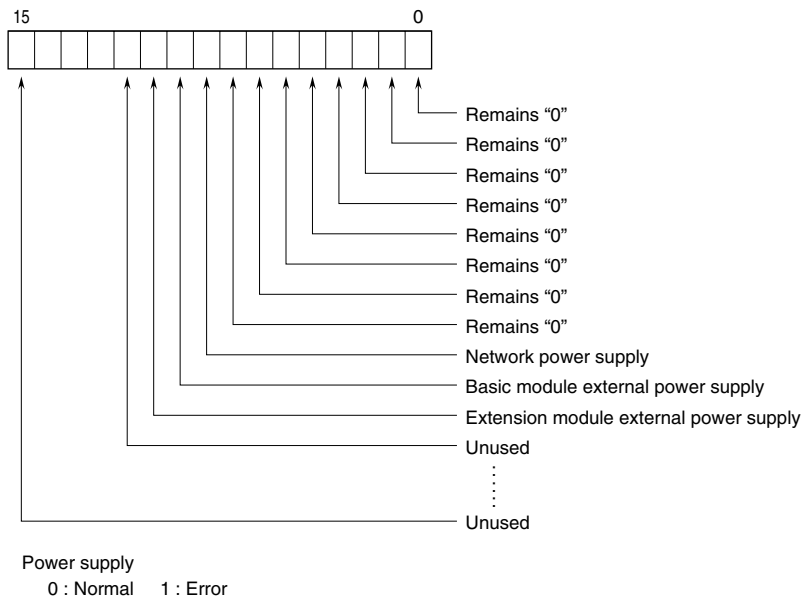

TRANSMISSION DATA DESCRIPTIONS

■ BASIC MODULE

Transmitted data (word) depends upon the modules types.

MODEL	OUTPUT DATA*1	INPUT DATA*2
	(R7D to Master)	(Master to R7D)
R7D-DC16x	0	1

■ EXTENSION MODULE

Transmitted data (word) for the extension module is added.

MODEL	OUTPUT DATA*1	INPUT DATA*2
	(R7D to Master)	(Master to R7D)
R7D-EAx	1	0
R7D-ECx	0	1

■ STATUS

Status signal can be included in the transmission data when the setting is enabled using the PC Configurator software (model: R7CON). For details, refer to “STATUS in I/O DATA DESCRIPTIONS”.

STATUS	OUTPUT DATA*1	INPUT DATA*2
	(R7D to Master)	(Master to R7D)
Enabled	1	0
Disabled	0	0

*1. Output Data means those sent to the master.

*2. Input Data means those received from the master.

WIRING INSTRUCTIONS

■ SCREW TERMINAL (Output)

Torque: 0.5 N·m

• SOLDERLESS TERMINAL

Refer to the drawing below for recommended ring tongue terminal size. Spade tongue type is also applicable.

Applicable wire size: 0.25 to 1.65 mm² (AWG 22 to 16)

Recommended manufacturer: Japan Solderless Terminal MFG. Co., Ltd, Nichifu Co., Ltd

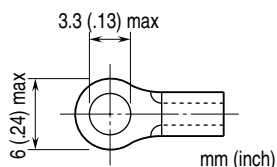

■ EURO TYPE CONNECTOR TERMINAL (DeviceNet)

Applicable wire size: 0.2 – 2.5 mm²

Stripped length: 7 mm

CONFORMITY WITH CE MARKING

■ CE MARKING

CE marking requires to integrate safety regulations existed in each country in EU territory and to secure smooth distribution of products of which safety is guaranteed. It is mandatory by law that products distributed and sold in EU territory to have CE mark which shows that the product conforms with the requirements of EU Directive. Each EU Directive describes the scope of apparatuses to which that EU Directive is applied. The R7D must conform with EMC Directive.

Each Directive states only basic requirements. In order to mark the CE on an assembled machinery equipment, its manufacturer needs to check the overall conformity with Directives applicable to it.

■ WARNINGS AND CAUTIONS WHEN INSTALLING THE R7D

The R7D needs to be installed in a control panel. This is effective not only to ensure general safety but also to contain noise emissions by the R7D inside the control panel. We conduct a series of testing to see that the product conforms to EMC Directive while it is installed in the control panel.

Warning and cautions when installing R7D are stated below.

- Use control panels with an internal panel plate, both made of metal, when installing the R7D.
- Make sure to adequately ground the control panel and the internal panel plate with a thick cable to maintain low impedance at high frequency.
- Use shielded cables for the signals taken out of the control panel.
- Choose a thick and short cable to ground the FG terminal of the R7D module to the internal panel plate of the control panel.
Note: If electromagnetic radiation disturbance increases by grounding the FG terminal, remove the grounding.
- When painting the internal plate of the control panel, apply masking to expose metal surface to secure conductivity at the sections where the following parts are attached:
 - Bolts attaching the internal panel to the control panel
 - Ground for the FG of the R7D module
 - Earth clamp on the shielded cable
- Noise emissions inside the control panel might leak through its openings. Design them as small as possible. Recommended diameter is 10 cm or less.

Supplement:

Additional measures may be taken depending upon actual installation sites. These points of cautions are illustrated in the next page.

- Prevent noise leakage by wrapping cables using shield covers, shield tubes and flexible conduits etc. if noise leaks through the cable outlet.
- Use an electromagnetic shield gasket and block up the gap between the control panel cabinet and its cover, if noise leaks through it.
- Connecting the internal panel plate and the cover of the control panel to the main cabinet using an earth strap may be effective to strengthen the grounding.
- Electromagnetically shielded control panel cabinet is effective for shielding.

• Points of cautions applicable when installing the R7D Series

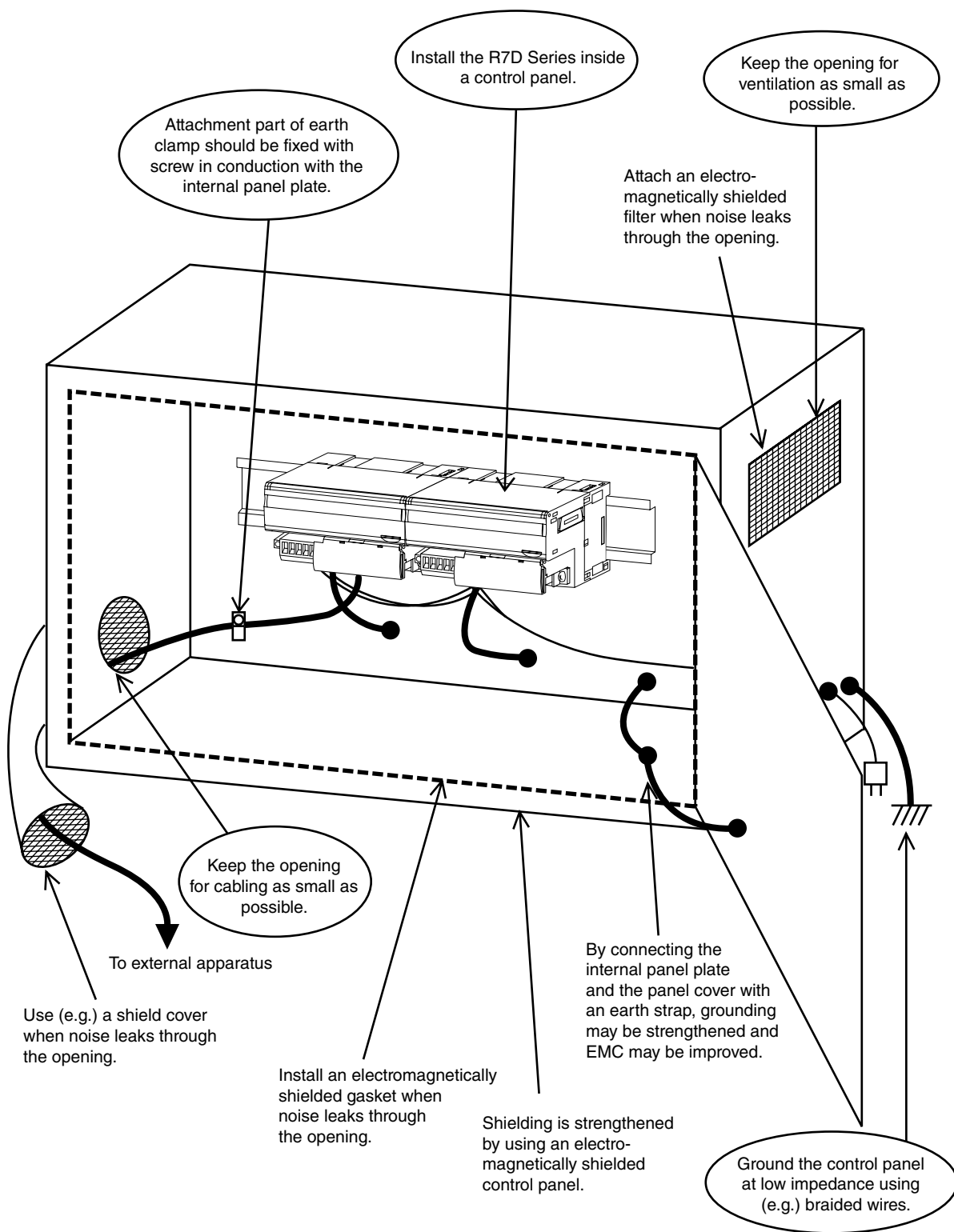

■ WARNINGS AND CAUTIONS WHEN LAYING CABLES

Signal cables connected to the R7D contain high-frequency components. Since these cables have the same effect as an antenna, they emit these high-frequency components to the external space as noise or overlap noise from the external space on themselves.

Cables with shielding should be used for the signal line due to the above reason.

EMC conformance test is conducted in the condition that shielded cables and earth clamps are used with the R7D.

Warning and cautions when laying cables are stated below. These points of cautions are illustrated in the next page.

- Use shielded cables for those signal cables installed out of the control panel and for thermocouple and RTD extension wires.
- All the network cables connected to R7D should be shielded.
- Use exclusively designed network cables for the DeviceNet.
- Expose the shield at a part of the cable cover, clip it with an earth clamp, and ground it to the internal panel of the control panel. A drain wire connected to the panel in a pig-tail form cannot maintain low impedance against high-frequency noise, thus grounding (noise shielding) in this form will not be effective.

Supplement:

Additional measures may be taken depending upon actual installation sites. These points of cautions are illustrated in the next page.

- Keep cables as short as possible. It prevents noise emissions from the cables and noise overlapping to the cables.
- Attach a ferrite core to reduce noise impact to the signal cables susceptible to the noise. Ferrite core can be attached close to the cable outlet of the control panel or close to the I/O terminal or connector, whichever is more effective. Also, the impact might be reduced by winding the cable around the ferrite core for extra turns or attaching multiple ferrite cores.
- Keep cables which are easily affected by noise away from those which can be a noise source.

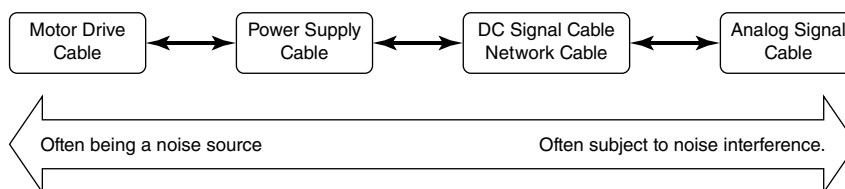

In the following are examples of effective ways to lay cables separately:

- Keeping physical distance (farther than 20 cm from motor drive cables, farther than 10 cm for other groups).
- Dividing off by a grounded metal plate
- Grouping into separate grounded metal pipes or cable shields.

Wires on each side of a filter should not be too close to each other. Noise could ride onto the other side of cable.

Extra attention needs to be paid at the following parts.

- Noise filter that is enclosed in power cables.
- Ferrite core that is attached to signal cables.
- Noise limiting circuit (surge quenching circuit, transient absorber circuit, etc.) that is enclosed in signal cables.

• Points of cautions applicable when wiring the R7D Series

