

**MECHATROLINK I/O MODULE**

(NPN discrete input, 16 points, e-CON connector, MECHATROLINK-III use)

MODEL R7G4FML3-B-DA16A

**BEFORE USE ....**

Thank you for choosing us. Before use, please check contents of the package you received as outlined below.

If you have any problems or questions with the product, please contact our sales office or representatives.

**■ PACKAGE INCLUDES:**

Discrete input module.....(1)  
DIN rail mounter slider.....(2)

**■ MODEL NO.**

Confirm Model No. marking on the product to be exactly what you ordered.

**■ INSTRUCTION MANUAL**

This manual describes necessary points of caution when you use this product, including installation, connection and basic maintenance procedures.

**POINTS OF CAUTION****■ CONFORMITY WITH EU DIRECTIVES**

- The equipment must be mounted inside the instrument panel of a metal enclosure.
- The actual installation environments such as panel configurations, connected devices, connected wires, may affect the protection level of this unit when it is integrated in a panel system. The user may have to review the CE requirements in regard to the whole system and employ additional protective measures to ensure the CE conformity.

**■ POWER INPUT RATING & OPERATIONAL RANGE**

- Locate the power input rating marked on the product and confirm its operational range as indicated below:  
24V DC rating: 24V  $\pm$ 10%, approx. 75mA

**■ GENERAL PRECAUTIONS**

- Before you remove the unit or mount it, turn off the power supply and input signal for safety.
- Before you remove the terminal block or mount it, make sure to turn off the power supply and input signal for safety.

**■ ENVIRONMENT**

- Indoor use.
- When heavy dust or metal particles are present in the air, install the unit inside proper housing with sufficient ventilation.
- Do not install the unit where it is subjected to continuous vibration. Do not subject the unit to physical impact.
- Environmental temperature must be within -10 to +55°C (14 to 131°F) with relative humidity within 30 to 90% RH in order to ensure adequate life span and operation.

**■ WIRING**

- Do not install cables close to noise sources (relay drive cable, high frequency line, etc.).
- Do not bind these cables together with those in which noises are present. Do not install them in the same duct.

**■ AND ....**

- The unit is designed to function as soon as power is supplied, however, a warm up for 10 minutes is required for satisfying complete performance described in the data sheet.

## COMPONENT IDENTIFICATION

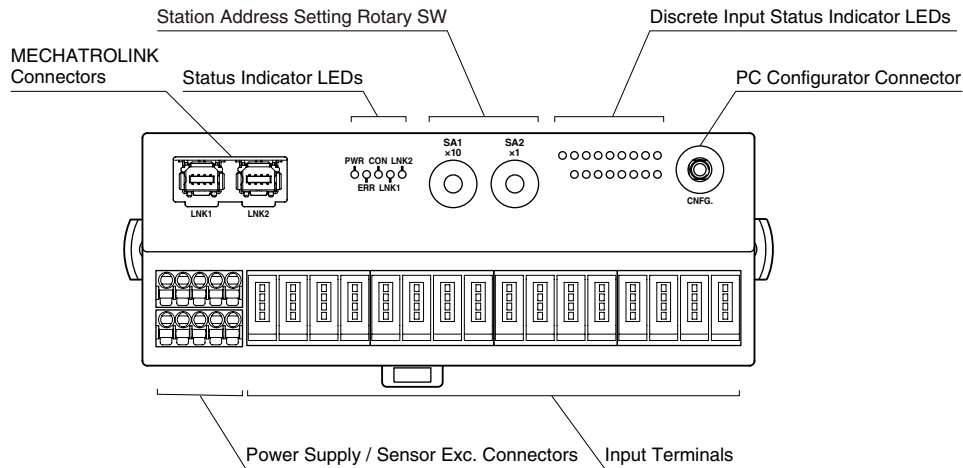

### ■ STATUS INDICATOR LED

ID	COLOR	FUNCTION
PWR	Green	Turns on when the internal power is supplied normally.
ERR	Red	Turns on at MECHATROLINK-III communication error
CON	Green	Turns on at MECHATROLINK-III connection is established
LNK1	Green	Turns on at MECHATROLINK-III LNK1 is established
LNK2	Green	Turns on at MECHATROLINK-III LNK2 is established

### ■ STATION ADDRESS

Station Address is selected between 03H and EFH in hexadecimal.

The SA1 switch determines the MSD, while the SA2 switch does the LSD of the address.

(Factory setting: 03H)

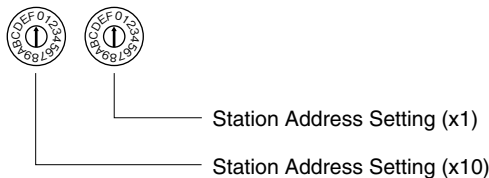

### ■ PC CONFIGURATOR JACK

The PC Configurator is used to set the following parameters for each channel.

- Read rate setting (Choose among 1 msec., 5 msec., 10 msec.(\*), 20 msec., 50 msec., 70 msec., 100 msec., 200 msec.)

For more information about the programming using the R7CFG, please refer to the R7CFG Users Manual.

(\*) Default setting

### ■ DISCRETE INPUT STATUS INDICATOR LED

LED green indicators shows the signal status.

- ON: LED ON
- OFF: LED OFF

### ■ POWER SUPPLY TERMINAL ASSIGNMENTS

**Cable connector:** FMC1,5/5-ST-3,5 (Phoenix Contact)  
(The cable connector is included in the package.)

**Applicable wire size:** 0.2 to 1.5 mm<sup>2</sup>

**Stripped length:** 10 mm

**Recommended solderless terminal:**

- AI0,25-10YE 0.25 mm<sup>2</sup> (Phoenix Contact)
- AI0,34-10TQ 0.34 mm<sup>2</sup> (Phoenix Contact)
- AI0,5-10WH 0.5 mm<sup>2</sup> (Phoenix Contact)
- AI0,75-10GY 0.75 mm<sup>2</sup> (Phoenix Contact)
- A1-10 1.0 mm<sup>2</sup> (Phoenix Contact)
- A1,5-10 1.5 mm<sup>2</sup> (Phoenix Contact)

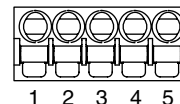

- |               |                   |
|---------------|-------------------|
| 1. PWR +      | Power Supply      |
| 2. PWR -      | Power Supply      |
| 3. FE         | Functional earth  |
| 4. SNSR.EXC + | Sensor excitation |
| 5. SNSR.EXC - | Sensor excitation |

Note: The numbers marked on the connector have no relationship to the pin number of the unit.

Wire according to the instruction manual of the unit.

## INPUT TERMINAL ASSIGNMENTS

**Recommended cable connector:** 37104-( )-000FL (3M Company)

(The cable connector is not included in the package. Specify wire size instead of ( ); refer to the specifications of the product.)

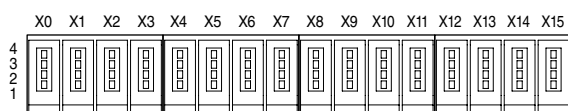

PIN No.	ID	FUNCTION	PIN No.	ID	FUNCTION
X0	1	+24V	X8	1	+24V
	2	NC		2	NC
	3	GND		3	GND
	4	X0		4	X8
X1	1	+24V	X9	1	+24V
	2	NC		2	NC
	3	GND		3	GND
	4	X1		4	X9
X2	1	+24V	X10	1	+24V
	2	NC		2	NC
	3	GND		3	GND
	4	X2		4	X10
X3	1	+24V	X11	1	+24V
	2	NC		2	NC
	3	GND		3	GND
	4	X3		4	X11
X4	1	+24V	X12	1	+24V
	2	NC		2	NC
	3	GND		3	GND
	4	X4		4	X12
X5	1	+24V	X13	1	+24V
	2	NC		2	NC
	3	GND		3	GND
	4	X5		4	X13
X6	1	+24V	X14	1	+24V
	2	NC		2	NC
	3	GND		3	GND
	4	X6		4	X14
X7	1	+24V	X15	1	+24V
	2	NC		2	NC
	3	GND		3	GND
	4	X7		4	X15

## MOUNTING INSTRUCTIONS

### ■ DIN RAIL MOUNTING (PARALLEL)

#### • Mounting

- 1) Set the upper hook at the rear side of the unit on the DIN rail.
- 2) Push the lower part in.

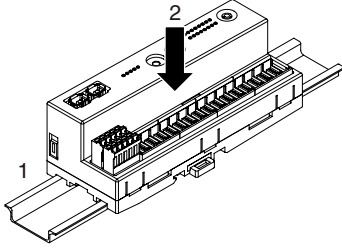

#### • Dismounting

- 1) Push down the DIN rail mouter slider with the tip of a flat-blade screwdriver.
- 2) Pull the lower part of the unit.
- 3) Remove the upper hook of the unit from the DIN rail.

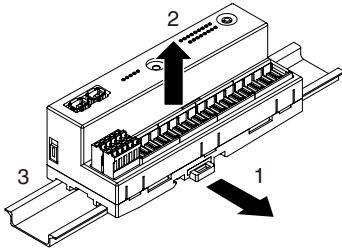

### ■ DIN RAIL MOUNTING (RIGHT ANGLE)

#### • Mounting

- 1) Insert the longer DIN rail mouter slider along the rail on the back of the unit until it clicks twice, as shown below.

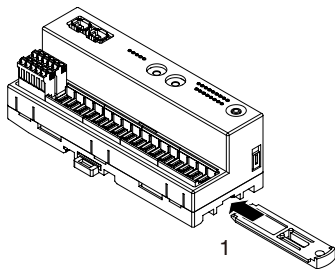

- 2) Set the upper hook at the rear side of the unit on the DIN rail.
- 3) Push the lower part in.

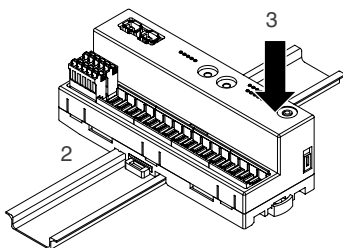

#### • Dismounting

- 1) Push down the DIN rail mouter slider with the tip of a flat-blade screwdriver.
- 2) Pull the lower part of the unit.
- 3) Remove the upper hook of the unit from the DIN rail.

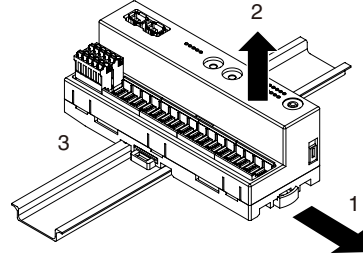

### ■ SURFACE MOUNTING

- 1) Insert the two DIN rail mouter sliders along the rail on the back of the unit until it clicks once, as shown below.

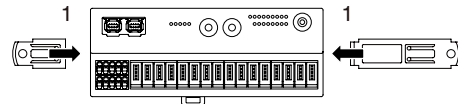

- 2) Mount the unit with M4 screws referring to the External Dimensions. (Torque: 1.4 N·m)

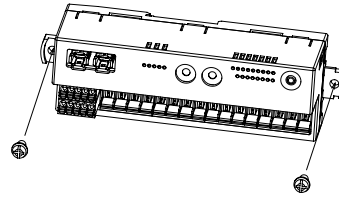

## TERMINAL CONNECTIONS

Connect the unit as in the diagram below.

### EXTERNAL DIMENSIONS unit: mm (inch)

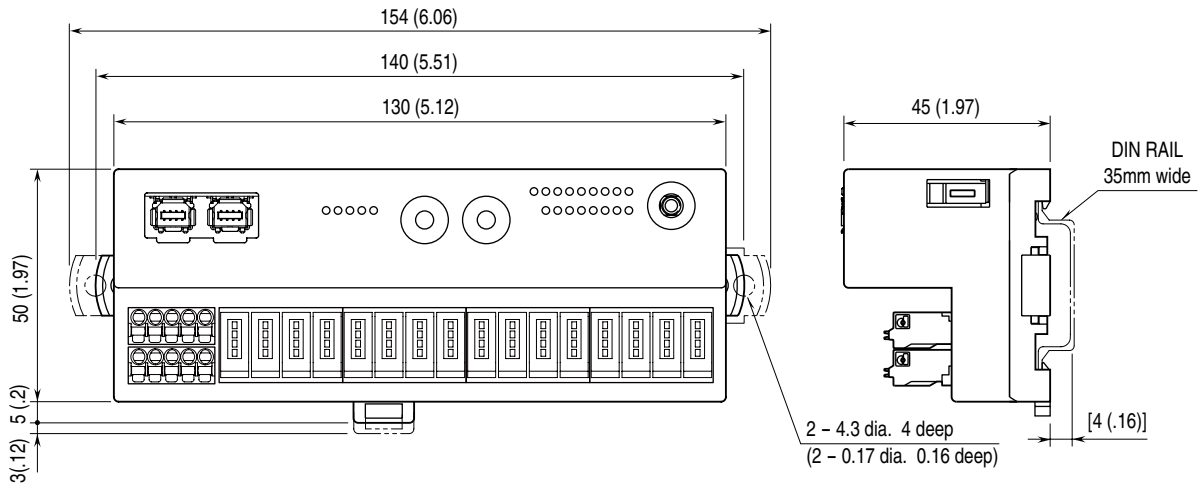

### CONNECTION DIAGRAM

Note: In order to improve EMC performance, bond the FE terminal to ground.

Caution: FE terminal is NOT a protective conductor terminal.

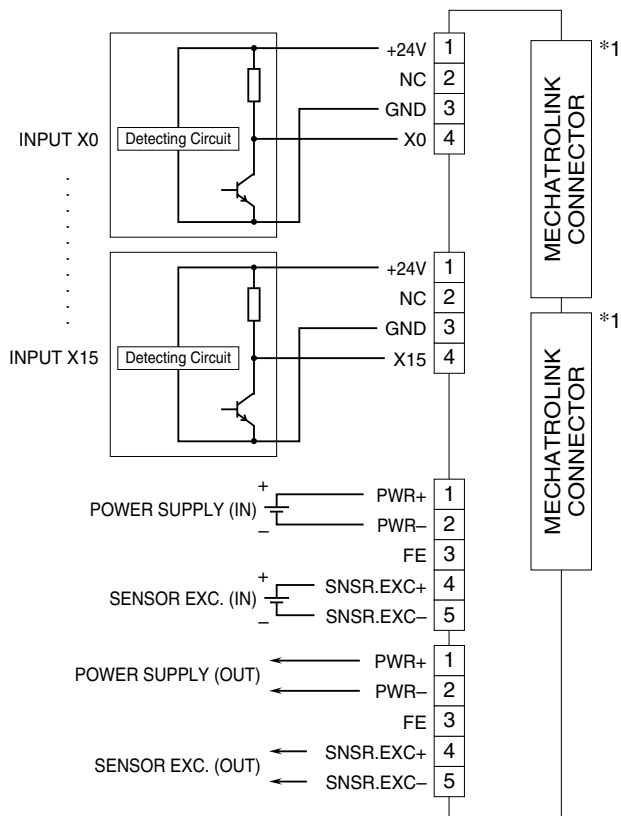

\*1. The network cable can be connected to either one.

### 2-Wire Sensor

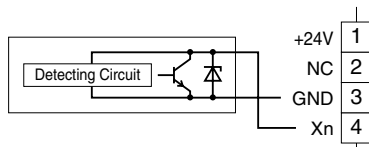

### MOUNTING REQUIREMENTS unit: mm (inch)

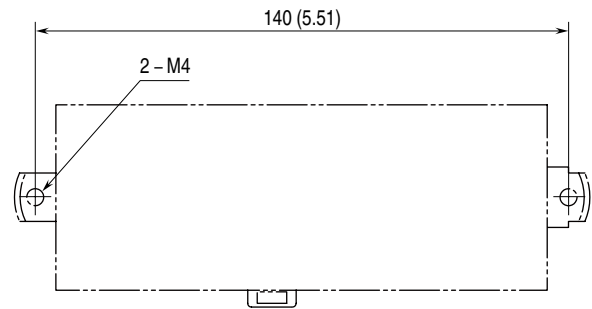

## MECHATROLINK-III COMMUNICATION

**Transmission cycle:** 125  $\mu$ sec., 250  $\mu$ sec., 500  $\mu$ sec., 1 – 64 msec. (with 1 msec. increments)

**Communication cycle:** 125  $\mu$ sec. through 64 msec.

**Applicable profile:** Standard I/O profile (cyclic communication)

Event-driven communication acquiring ID profile (event-driven communication)

**Transmission bytes:** 16 bytes

**Station address:** 03H through EFH (set with rotary switches)

**Cyclic communication:** Available

**Event-driven communication:** Available

**Slave monitoring:** None

## MECHATROLINK-III RELATED COMMANDS

Commands available with this unit are the following.

PROFILE	COMMAND	CODE	FUNCTION
Common command	NOP	00H	No operation command
	ID_RD	03H	Read ID command
	CONFIG	04H	Setup device command
	ALM_RD	05H	Read alarm or warning command
	ALM_CLR	06H	Clear alarm or warning command
	CONNECT	0EH	Establish connection command
	DISCONNECT	0FH	Release connection command
Standard I/O profile	DATA_RWA	20H	Transmit I/O data

### • NOP (00H)

Does nothing except sending back current status

BYTE	COMMAND	RESPONSE	REMARKS
0	NOP (00H)	NOP (00H)	No operation command
1	00H	00H	Not used
2	CMD_CTRL	CMD_STAT	Refer to CMD_CTRL/CMD_STAT.
3			
$\geq 4$	00H	00H	Reserve

### • ID\_RD (03H)

Reads the product ID.

BYTE	COMMAND	RESPONSE	REMARKS
0	ID_RD (03H)	ID_RD (03H)	Read ID command
1	00H	00H	Not used
2	CMD_CTRL	CMD_STAT	Refer to CMD_CTRL/CMD_STAT.
3			
4	ID_CODE	ID_CODE	Refer to ID_CODE
5	OFFSET	OFFSET	OFFSET: designates the place to read data
6	SIZE	SIZE	SIZE: specify the size of data to read
7			
$\geq 8$	00H	ID	Product's ID

### • CONFIG (04H)

No parameter to set for this unit. Immediately response with completion.

BYTE	COMMAND	RESPONSE	REMARKS
0	CONFIG (04H)	CONFIG (04H)	Setup device command
1	00H	00H	Not used
2	CMD_CTRL	CMD_STAT	Refer to CMD_CTRL/CMD_STAT.
3			
4	00H	00H	Recalculation of parameters and set up. Other than 00H is not supported.
$\geq 5$	00H	00H	Reserve

• **ALM\_RD (05H)**

Reads alarm or warning

BYTE	COMMAND	RESPONSE	REMARKS
0	ALM_RD (05H)	ALM_RD (05H)	Read alarm or warning command
1	00H	00H	Not used
2	CMD_CTRL	CMD_STAT	Refer to CMD_CTRL/CMD_STAT.
3			
4	0000H	0000H	Read current alarm or warning. 12 points max. (2 bytes in 8th to 31st byte) Other than 0000H is not available.
5			
6	0000H	0000H	0
7			
≥ 8	00H	00H	0

• **ALM\_CLR (06H)**

Clears alarm or warning

BYTE	COMMAND	RESPONSE	REMARKS
0	ALM_CLR (06H)	ALM_CLR (06H)	Clear alarm or warning command
1	00H	00H	Not used
2	CMD_CTRL	CMD_STAT	Refer to CMD_CTRL/CMD_STAT.
3			
4	0000H	0000H	Clear current alarm or warning. Other than 0000H is not available.
5			
≥ 6	00H	00H	Reserve

• **CONNECT (0EH)**

Starts communication with master station.

BYTE	COMMAND	RESPONSE	REMARKS
0	CONNECT (0EH)	CONNECT (0EH)	Establish connection command
1	00H	00H	Not used
2	CMD_CTRL	CMD_STAT	Refer to CMD_CTRL/CMD_STAT.
3			
4	30H	30H	MECHATROLINK application layer: 30H
5	00H	00H	Communication mode: Asynchronous, single transmission, subcommand disabled
6	COM_TIME	COM_TIME	Communication cycle: Multiple of transmission cycle. E.g. Transmission cycle: 0.5 msec., communication cycle: 2 msec. Set 4 (=2/0.5)
7	30H or 01H	30H or 01H	Profile type 30H: Standard I/O profile 01H: Event-driven communication acquiring ID profile
≥ 8	00H	00H	Reserve

• **DISCONNECT (0FH)**

Stops communication with master station.

BYTE	COMMAND	RESPONSE	REMARKS
0	DISCONNECT (0FH)	DISCONNECT (0FH)	Release connection command
≥ 1	00H	00H	Reserve

• **DATA\_RWA (20H)**

Transmits I/O data to master station. Data allocation is following.  
Data size is 16 bytes.

BYTE	COMMAND	RESPONSE	REMARKS
0	DATA_RWA (20H)	DATA_RWA (20H)	Transmit I/O Data
1	00H	00H	Not used
2	CMD_CTRL	CMD_STAT	Refer to CMD_CTRL/CMD_STAT.
3			
4	CH0 OUT LO	CH0 IN LO	CHx OUT: Output data: See 'Output Data' of 'I/O DATA' CHx IN: Input data: See 'Input Data' of 'I/O DATA'
5	CH0 OUT HI	CH0 IN HI	
6	CH1 OUT LO	CH1 IN LO	
7	CH1 OUT HI	CH1 IN HI	
8	CH2 OUT LO	CH2 IN LO	
9	CH2 OUT HI	CH2 IN HI	
10	CH3 OUT LO	CH3 IN LO	
11	CH3 OUT HI	CH3 IN HI	
12	00H	00H	Not used
13	00H	00H	Not used
14	00H	00H	Not used
15	00H	00H	Not used

[ I/O DATA ]

• **Input data**

Input data to be sent from the slave to the master are set in the response.

CH0 IN LO	CH0 data low 8 bits	Bit 0 through 7 of input data are set
CH0 IN HI	CH0 data high 8 bits	Bit 8 through 15 of input data are set
CH1 IN LO	CH1 data low 8 bits	Not used
CH1 IN HI	CH1 data high 8 bits	Not used
CH2 IN LO	CH2 data low 8 bits	Not used
CH2 IN HI	CH2 data high 8 bits	Not used
CH3 IN LO	CH3 data low 8 bits	Not used
CH3 IN HI	CH3 data high 8 bits	Not used

• **Output Data**

Unused with all input modules.

CH0 OUT LO	CH0 data low 8 bits	Not used
CH0 OUT HI	CH0 data high 8 bits	Not used
CH1 OUT LO	CH1 data low 8 bits	Not used
CH1 OUT HI	CH1 data high 8 bits	Not used
CH2 OUT LO	CH2 data low 8 bits	Not used
CH2 OUT HI	CH2 data high 8 bits	Not used
CH3 OUT LO	CH3 data low 8 bits	Not used
CH3 OUT HI	CH3 data high 8 bits	Not used



**CMD\_CTRL**

CMD\_CTRL command area is following.

BIT	FUNCTION	REMARKS
0 – 2	Reserve	Not used
3	ALM_CLR	0: Clear alarm/warning disabled 1: Clear alarm/warning triggered
4 – 5	Reserve	Not used
6 – 7	CMD_ID	Not used in the standard I/O command profile
8 – 15	Reserve	Not used

**CMD\_STAT**

CMD\_STAT response area is following.

BIT	FUNCTION	REMARKS	
0	D_ALM	Not used	
1	D_WAR	Not used	
2	CMDRDY	1: Command reception enabled 0: Other	
3	ALM_CLR_CMP	1: Completion of execution of ALM_CLR 0: Other ALM_CLR_CMP can be canceled by setting '0' for ALM_CLR in CMD_CTRL command area.	
4 – 5	Reserve	Not used	
6 – 7	RCMD_ID	Not used in the standard I/O command profile	
8 – 11	CMD_ALM	Warning	0: Normal, 1: Invalid data
		Alarm	8: Unsupported command received, 9: Invalid data, A: Command execution condition error, B: Subcommand combination error, C: Phase error
12 – 15	COMM_ALM	Warning	0: Normal, 1: FCS error, 2: Command data not received, 3: Synchronous frame not received
		Alarm	8: FCS error, 9: Command data not received, A: Synchronous frame not received, B: Synchronization time interval error, C: WDT error

**ID\_CODE**

ID\_CODE is following.

ID_CODE	NAME	SIZE (BYTES)	SUPPORT	VALUE (HEXADECIMAL)	REMARKS
01H	Vendor ID Code	4	Yes	0x00000021	M-SYSTEM CO., LTD.
02H	Device Code	4	Yes	0x00000700	R7G4FML3-B-DA16A
03H	Device Version	4	Yes	Firmware version	E.g. 1.00 -> 0x0064
04H	Device Definition File version	4	Yes	0x00001000	
05H	Extended Address Setting	4	Yes	0x00000001	
06H	Serial No.	32	Yes	Unit serial number	E.g. AB123456 -> 0x32314241 0x36353433 0x00000000 0x00000000 0x00000000 0x00000000 0x00000000 0x00000000
10H	Profile Type 1	4	Yes	0x00000030	Standard I/O profile
11H	Profile Version 1	4	Yes	0x00000100	
12H	Profile Type 2	4	Yes	0x000000FF	Indicates the unit does not support
13H	Profile Version 2	4	Yes	0x00000000	
14H	Profile Type 3	4	Yes	0x000000FF	Indicates the unit does not support
15H	Profile Version 3	4	Yes	0x00000000	
16H	Min. Transmission Cycle	4	Yes	0x000030D4	125 μsec.
17H	Max. Transmission Cycle	4	Yes	0x0061A800	64 msec.
18H	Increments of Transmission Cycle	4	Yes	0x00000001	Available to 31.25, 62.5, 125, 250, 500 [μsec.] & 1 – 64 [msec.] (1 msec. increments)
19H	Min. Communication Cycle	4	Yes	0x000030D4	125 μsec.
1AH	Max. Communication Cycle	4	Yes	0x0061A800	64 msec.
1BH	Transmission Bytes	4	Yes	0x00000002	16 Bytes
1CH	Transmission Bytes (Current Setting)	4	Yes	0x00000002	16 Bytes
1DH	Profile Type (Current Selection)	4	Yes	0x00000001 / 0x00000030	Event-driven communication / Cyclic communication
20H	Supported Communication Mode	4	Yes	0x00000003	Event-driven communication / Cyclic communication
21H	MAC Address	4	No	----	
30H	List of Supported Main Commands	32	Yes	0x0000C079 0x00000001 0x00000000 0x00000000 0x00000000 0x00000000 0x00000000 0x00000000	ALM_CLR, ALM_RD, CONFIG, ID_RD, NOP, DISCONNECT, CONNECT, DATA_RWA
38H	List of Supported Sub Commands	32	No	----	
40H	List of Common Parameters	32	No	----	
80H	Main Device Name	32	Yes	0x34473752 0x334C4D46 0x442D422D 0x41363141 0x00000000 0x00000000 0x00000000 0x00000000	“R7G4FML3-B-DA16A”
90H	Sub Device 1 Name	4	No	----	
98H	Sub Device 1 Version	32	No	----	
A0H	Sub Device 2 Name	4	No	----	
A8H	Sub Device 2 Version	32	No	----	
B0H	Sub Device 3 Name	4	No	----	
B8H	Sub Device 3 Version	32	No	----	

## I/O DATA DESCRIPTION

### ■ DISCRETE INPUT MODULE

