

BEFORE USE

Thank you for choosing us. Before use, please check contents of the package you received as outlined below.

If you have any problems or questions with the product, please contact our sales office or representatives.

■ PACKAGE INCLUDES:

Transistor output module.....(1)
DIN rail mounter slider.....(2)

■ MODEL NO.

Confirm Model No. marking on the product to be exactly what you ordered.

■ INSTRUCTION MANUAL

This manual describes necessary points of caution when you use this product, including installation, connection and basic maintenance procedures.

■ EDS FILE

EDS files are downloadable at our web site.

POINTS OF CAUTION**■ CONFORMITY WITH EU DIRECTIVES**

- The equipment must be mounted inside the instrument panel of a metal enclosure.
- The actual installation environments such as panel configurations, connected devices, connected wires, may affect the protection level of this unit when it is integrated in a panel system. The user may have to review the CE requirements in regard to the whole system and employ additional protective measures to ensure the CE conformity.

■ POWER INPUT RATING & OPERATIONAL RANGE

- Locate the power input rating marked on the product and confirm its operational range as indicated below:
24V DC rating: 24V \pm 10%, approx. 50mA

■ GENERAL PRECAUTIONS

- Before you remove the unit or mount it, turn off the power supply and output signal for safety.
- Before you remove the terminal block or mount it, make sure to turn off the power supply and output signal for safety.

■ ENVIRONMENT

- Indoor use.
- When heavy dust or metal particles are present in the air, install the unit inside proper housing with sufficient ventilation.
- Do not install the unit where it is subjected to continuous vibration. Do not subject the unit to physical impact.
- Environmental temperature must be within -10 to +55°C (14 to 131°F) with relative humidity within 30 to 90% RH in order to ensure adequate life span and operation.

■ WIRING

- Do not install cables close to noise sources (relay drive cable, high frequency line, etc.).
- Do not bind these cables together with those in which noises are present. Do not install them in the same duct.
- Be sure to close the terminal cover for safety.

■ AND

- The unit is designed to function as soon as power is supplied, however, a warm up for 10 minutes is required for satisfying complete performance described in the data sheet.

COMPONENT IDENTIFICATION

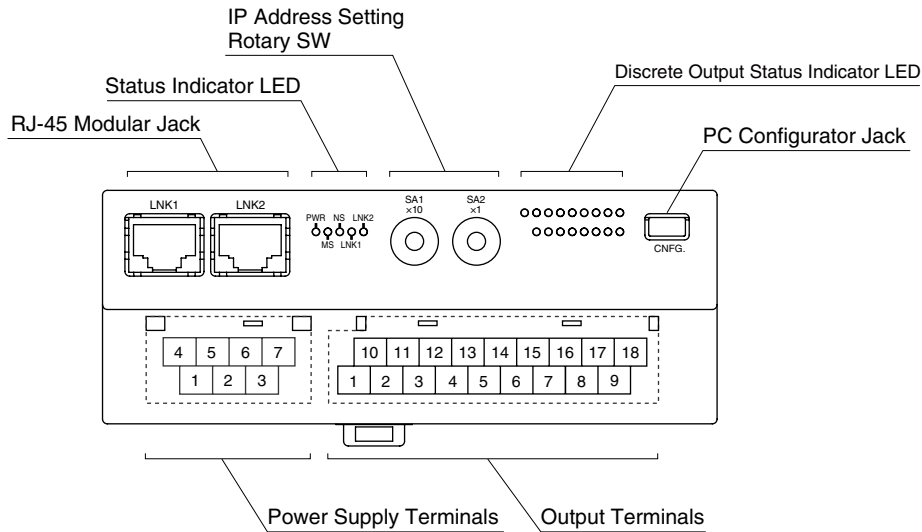

■ STATUS INDICATOR LED

ID	STATUS	COLOR	FUNCTION
PWR	ON	Green	The internal power is supplied normally.
MS	ON	Green	Operating in a normal condition
	Blinking	Red	Duplicated IP address, Internal data error
NS	ON	Green	Link on-line and connections in the established state
	Blinking		Link on-line but no connections in the established state
	ON	Red	Duplicated IP address
	Blinking		Communication timeout
LNK1	ON	Green	LNK1 is established
LNK2	ON	Green	LNK2 is established

■ DISCRETE OUTPUT STATUS INDICATOR LED

LED green indicators shows the signal status.

ON : LED ON

OFF : LED OFF

■ IP ADDRESS

Set the host address (2-digit hexadecimal number) in the IP address using rotary switches SA1 and SA2 for the first digit and the second digit, respectively.

When using the host address in the IP address set on the PC configurator software (model: R7CFG), set the switches to '00H'.

When the network address, Subnet Mask, and Default Gateway need to be changed, do so on R7CFG.

(Setting range: 00H – FFH)

(Factory setting: 00H)



■ POWER SUPPLY TERMINAL ASSIGNMENT

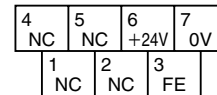

- 1. NC -
- 2. NC -
- 3. FE Functional earth
- 4. NC -
- 5. NC -
- 6. +24V Power supply (24V DC)
- 7. 0V Power supply (0V)

■ OUTPUT TERMINAL ASSIGNMENTS

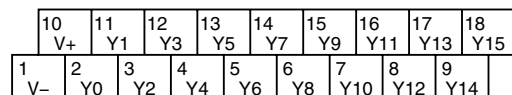

NO.	ID	FUNCTION	NO.	ID	FUNCTION
1	V-	0V	10	V+	24V DC (Out. Common)
2	Y0	Output 0	11	Y1	Output 1
3	Y2	Output 2	12	Y3	Output 3
4	Y4	Output 4	13	Y5	Output 5
5	Y6	Output 6	14	Y7	Output 7
6	Y8	Output 8	15	Y9	Output 9
7	Y10	Output 10	16	Y11	Output 11
8	Y12	Output 12	17	Y13	Output 13
9	Y14	Output 14	18	Y15	Output 15

MOUNTING INSTRUCTIONS

■ DIN RAIL MOUNTING (PARALLEL)

• Mounting

- 1) Set the upper hook at the rear side of the unit on the DIN rail.
- 2) Push the lower part in.

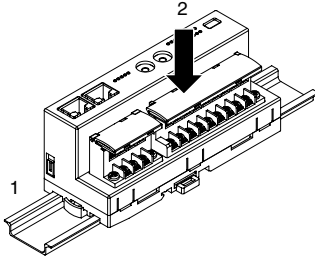

• Dismounting

- 1) Push down the DIN rail mouter slider with the tip of a flat-blade screwdriver.
- 2) Pull the lower part of the unit.
- 3) Remove the upper hook of the unit from the DIN rail.

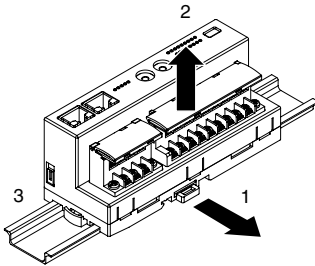

■ SURFACE MOUNTING

- 1) Insert the two DIN rail mouter sliders until it clicks once, as shown below.

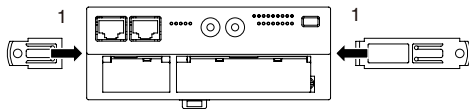

- 2) Mount the unit with M4 screws referring to the External Dimensions. (Torque: 1.4 N·m)

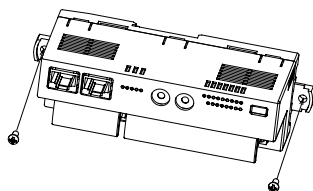

■ DIN RAIL MOUNTING (RIGHT ANGLE)

• Mounting

- 1) Insert the longer DIN rail mouter slider until it clicks twice, as shown below.

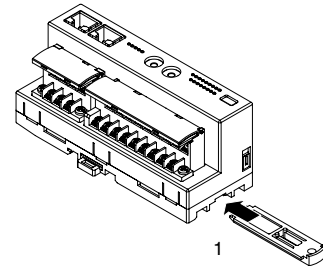

- 2) Set the upper hook at the rear side of the unit on the DIN rail.
- 3) Push the lower part in.

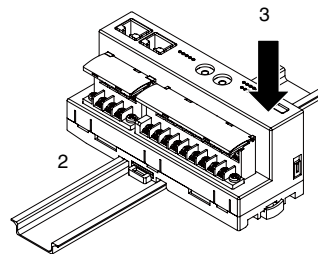

• Dismounting

- 1) Push down the DIN rail mouter slider with the tip of a flat-blade screwdriver.
- 2) Pull the lower part of the unit.
- 3) Remove the upper hook of the unit from the DIN rail.

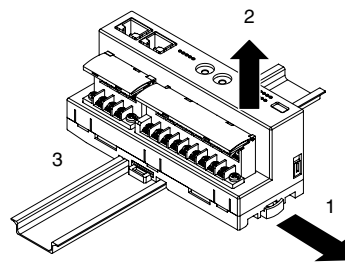

TERMINAL CONNECTIONS

Connect the unit as in the diagram below.

EXTERNAL DIMENSIONS unit: mm (inch)

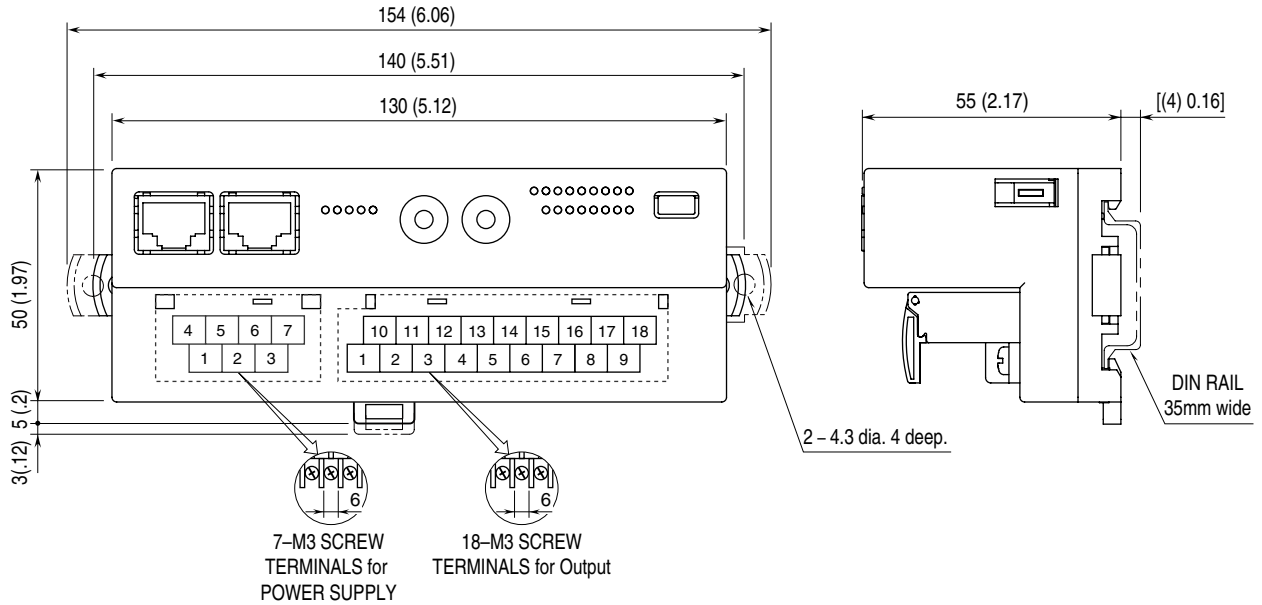

CONNECTION DIAGRAM

Note: In order to improve EMC performance, bond the FE terminal to ground.
Caution: FE terminal is NOT a protective conductor terminal.

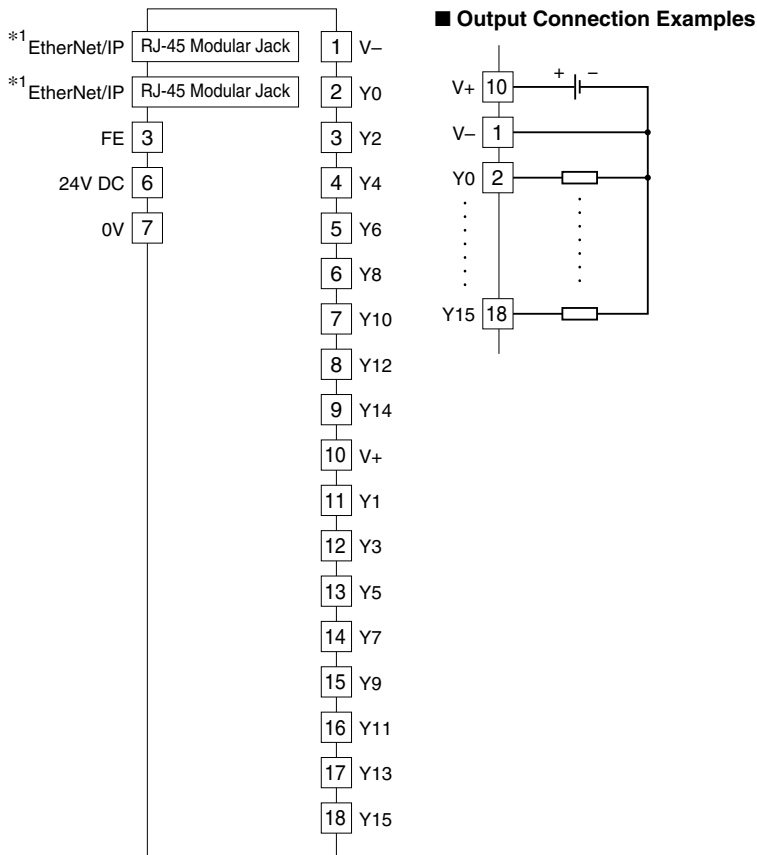

*1. The network cable can be connected to either one.

MOUNTING REQUIREMENTS unit: mm (inch)

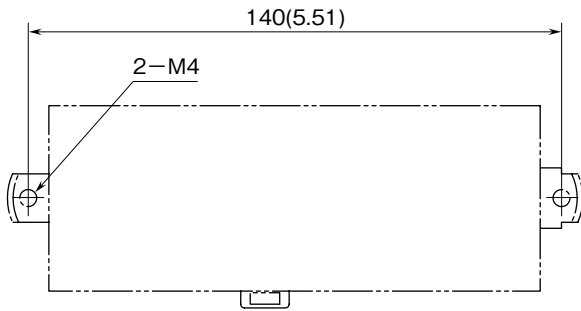

WIRING INSTRUCTIONS

■ TORQUE

Wiring screw for separable terminal: 0.5 N m
 Fixing screw for separable terminal: 0.5 N m

■ SOLDERLESS TERMINAL

Refer to the drawing below for recommended ring tongue terminal size. Spade tongue type is also applicable.
 Recommended manufacturer: Japan Solderless Terminal MFG.Co.Ltd, Nichifu Co.,ltd
 Applicable wire size: 0.25 to 1.65 mm² (AWG 22 to 16)

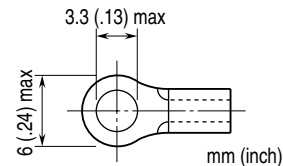

■ HOW TO DETACH REMOVABLE TERMINAL BLOCK

The terminal block has a removable two-piece structure. Loosen screws of the terminal block alternately to detach it from the unit.

PC CONFIGURATOR

The following parameter items can be configured with the PC configurator software (model: R7CFG). Refer to the users manual of the software for detailed operations.

■ CHANNEL BATCH SETTING

PARAMETER	SETTING RANGE	DEFAULT SETTING
Output Hold/Clear	Hold / Clear	Hold

■ ETHERNET SETTING

PARAMETER	SETTING RANGE	DEFAULT SETTING
IP Address	0.0.0.0 – 255.255.255.255	192.168.0.250
Subnet Mask	0.0.0.0 – 255.255.255.255	255.255.255.0
Default Gateway	0.0.0.0 – 255.255.255.255	192.168.0.1
Time Out	0.0 – 3276.7 (sec.)	3.0 (sec.)
Use IP Address	DHCP / CONFIG	CONFIG

CHECKING ETHERNET/IP CONNECTION

■ IP ADDRESS

Set the host address in the IP address using the front rotary switches.

When using the host address in the IP address set on the PC configurator software (model:R7CFG), set the switches to '00H'. When the network address, Subnet Mask, and Default Gateway need to be changed, do so on R7CFG.

■ CHECK WIRING

Connect an Ethernet cable to the front RJ-45 modular jack.

To configure a DLR (Device Level Ring) network, perform wiring so as to form a ring topology.

The DLR network requires at least one node as a ring supervisor.

The customer shall prepare one or more ring supervisors separately as the R7G4HEIP unit does not function as one.

■ CHECK LED

When wiring is correct, LNK1 or LNK2 is turned on.

■ CHECK R7G4HEIP CONNECTION

Enter "ping command" on the Windows MS-DOS as follows:

```
C:\WINDOWS>ping *.*.*.*.*
(*.*.*.*.*: Enter IP address in decimal.)

ping *.*.*.*.* with 32 bytes of data:
Reply from *.*.*.*.* : bytes=32 time<10ms TTL=64
Reply from *.*.*.*.* : bytes=32 time<10ms TTL=64
Reply from *.*.*.*.* : bytes=32 time<10ms TTL=64
Reply from *.*.*.*.* : bytes=32 time<10ms TTL=64

Ping statistics for *.*.*.*.*
Packets:Sent=4,Received=4,Lost=0(0% loss)
```

Replies in case of normal connection are as shown above. If the connection cannot be established normally due to e.g. wrong IP address, other replies such as "time over" will be received.

■ CHECK CONNECTION TO THE APPLICATION SOFTWARE

Check Point 1: LINK LED

LNK1 or LNK2 turns on when the module has established normal connections with PC, PLC, hub, and so on, regardless of data sending/receiving status.

In the case that they are not on, check power supply to the hub.

Check Point 2: MS AND NS INDICATOR

When the module has transmitted/received data correctly to/from the application software, MS and NS indicators turn on in green.

I/O DATA DESCRIPTION

■ DISCRETE OUTPUT MODULE

