

MECHATROLINK I/O MODULE

(tension sensor input (Nireco tension sensor), 2 points, isolated, screw terminal block, message transmission command, MECHATROLINK- III use)

MODEL R7G4HML3-6-LC2A**BEFORE USE**

Thank you for choosing us. Before use, please check contents of the package you received as outlined below. If you have any problems or questions with the product, please contact our sales office or representatives.

■ PACKAGE INCLUDES:

Tension sensor input module.....(1)
DIN rail mounter slider.....(2)

■ MODEL NO.

Confirm Model No. marking on the product to be exactly what you ordered.

■ INSTRUCTION MANUAL

This manual describes necessary points of caution when you use this product, including installation, connection and basic maintenance procedures.

POINTS OF CAUTION**■ CONFORMITY WITH EU DIRECTIVES**

- The equipment must be mounted inside the instrument panel of a metal enclosure.
- The actual installation environments such as panel configurations, connected devices, connected wires, may affect the protection level of this unit when it is integrated in a panel system. The user may have to review the CE requirements in regard to the whole system and employ additional protective measures to ensure the CE conformity.

■ POWER INPUT RATING & OPERATIONAL RANGE

- Locate the power input rating marked on the product and confirm its operational range as indicated below:
24V DC rating: 24V \pm 10%, approx. 100mA

■ GENERAL PRECAUTIONS

- Before you remove the unit or mount it, turn off the power supply and input signal for safety.
- Before you remove the terminal block or mount it, make sure to turn off the power supply and input signal for safety.

■ ENVIRONMENT

- Indoor use.
- When heavy dust or metal particles are present in the air, install the unit inside proper housing with sufficient ventilation.
- Do not install the unit where it is subjected to continuous vibration. Do not subject the unit to physical impact.
- Environmental temperature must be within -10 to +55°C (14 to 131°F) with relative humidity within 30 to 90% RH in order to ensure adequate life span and operation.

■ WIRING

- Do not install cables close to noise sources (relay drive cable, high frequency line, etc.).
- Do not bind these cables together with those in which noises are present. Do not install them in the same duct.
- Be sure to close the terminal cover for safety.

■ AND

- The unit is designed to function as soon as power is supplied, however, a warm up for 10 minutes is required for satisfying complete performance described in the data sheet.

COMPONENT IDENTIFICATION

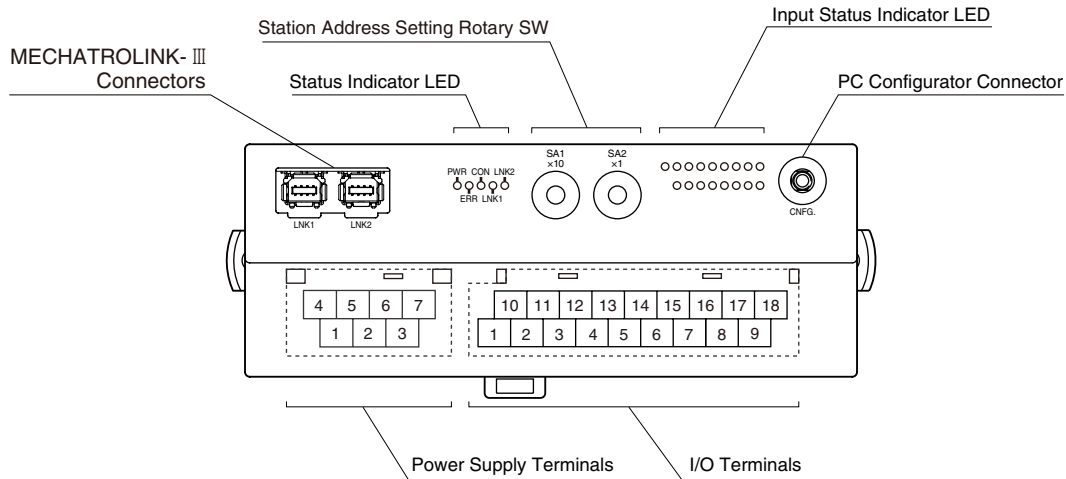

■ STATUS INDICATOR LED

ID	COLOR	FUNCTION
PWR	Green	Turns on when the internal power is supplied normally
ERR	Red	Turns on at MECHATROLINK-III communication error
CON	Green	Turns on when MECHATROLINK-III connection is established
LNK1	Green	Turns on when MECHATROLINK-III LNK1 is established
LNK2	Green	Turns on when MECHATROLINK-III LNK2 is established

■ INPUT STATUS INDICATOR LED

ID	COLOR	FUNCTION
A. ZERO	Green	Blink once when auto zero is performed
ZERO	Green	Blink once when zero adjustment is performed
SPAN	Green	Blink once when span adjustment is performed
MODE	Green	OFF at normal output mode ON at monitor output mode
RESET	Green	Blink once when reset offset
UNDER	Green	ON at (input signal ≤ -1%)
0-100	Green	ON at (-1% < input signal < 101%)
OVER	Green	ON at (input signal ≥ 101%)

■ STATION ADDRESS

Station Address is selected between 03H and EFH in hexadecimal.

The SA1 switch determines the MSD, while the SA2 switch does the LSD of the address.

(Factory setting: 03H)

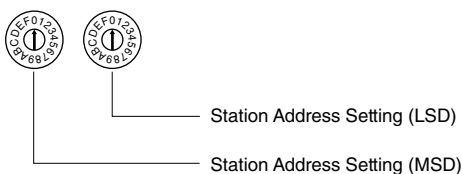

■ POWER SUPPLY TERMINAL ASSIGNMENT

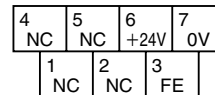

- 1. NC -
- 2. NC -
- 3. FE Functional earth
- 4. NC -
- 5. NC -
- 6. +24V Power supply (24V DC)
- 7. 0V Power supply (0V)

■ I/O TERMINAL ASSIGNMENT

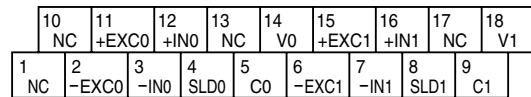

NO.	ID	FUNCTION	NO.	ID	FUNCTION
1	NC	No connection	10	NC	No connection
2	-EXC0	Excitation 0 -	11	+EXC0	Excitation 0 +
3	-IN0	Input 0 -	12	+IN0	Input 0 +
4	SLD0	Shield 0	13	NC	No connection
5	C0	Monitor output 0 -	14	V0	Monitor output 0 +
6	-EXC1	Excitation 1 -	15	+EXC1	Excitation 1 +
7	-IN1	Input 1 -	16	+IN1	Input 1 +
8	SLD1	Shield 1	17	NC	No connection
9	C1	Monitor output 1 -	18	V1	Monitor output 1 +

PC CONFIGURATOR

The following parameter items can be set with using PC Configurator Software (model: R7CFG). Refer to the users manual for the R7CFG for detailed operation of the software program.

CHANNEL INDIVIDUAL SETTING

PARAMETER	SETTING RANGE	DEFAULT SETTING
Zero adjustment	Not exceeding allowable roll weight of the sensor	—
Span adjustment	10% to full scale	Full scale
Auto zero	—	—
Reset offset	—	—
Auto scale	0 to 32 000	—
Bias	-320.00 to +320.00 (%)	0.00 (%)
Gain	-3.2000 to +3.2000	1.0000
Zero scale	-32 000 to +32 000	0
Full scale	-32 000 to +32 000	10 000
Load ratio	10.00 to 100.00 (%)	100.00 (%)
Averaging	2, 4, 8, 16, 32, 64, 128, 256, 512, 1024	16
Lowpass filter	2Hz, 2kHz	2kHz
Monitor output	-115.00 to +115.00 (%)	—

MOUNTING INSTRUCTIONS

DIN RAIL MOUNTING (PARALLEL)

• Mounting

- 1) Set the upper hook at the rear side of the unit on the DIN rail.
- 2) Push in the lower.

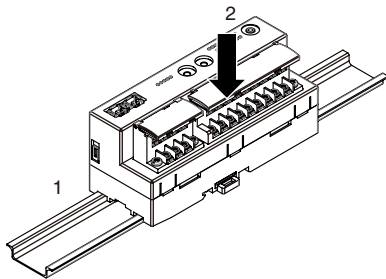

• Dismounting

- 1) Push down the DIN rail mounter slider with tip of a minus screwdriver.
- 2) Pull the lower of the unit.
- 3) Remove the upper hook of the unit from the DIN rail.

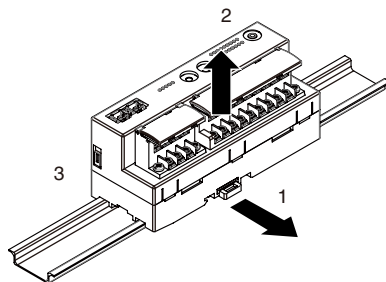

DIN RAIL MOUNTING (RIGHT ANGLE)

• Mounting

- 1) Insert the longer DIN rail mounter slider until it clicks twice, as shown below.

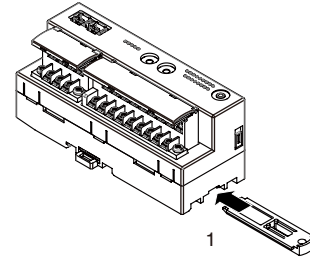

- 2) Set the upper hook at the rear side of the unit on the DIN rail.

- 3) Push in the lower.

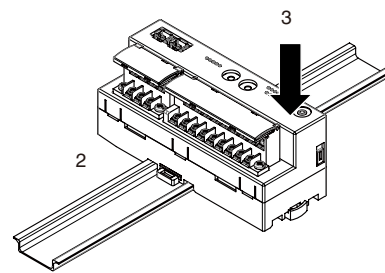

• Dismounting

- 1) Push down the DIN rail mounter slider with tip of a minus screwdriver.
- 2) Pull the lower of the unit.
- 3) Remove the upper hook of the unit from the DIN rail.

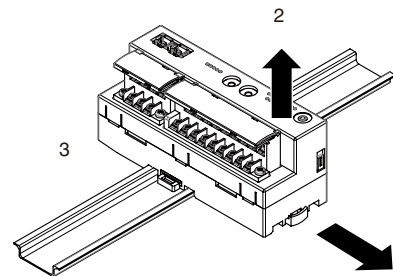

SURFACE MOUNTING

- 1) Insert the two DIN rail mounter sliders until it clicks once, as shown below.

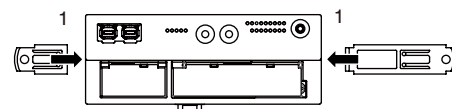

- 2) Mount the unit with M4 screws referring the External Dimensions. (Torque: 1.4 N·m)

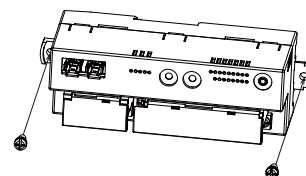

TERMINAL CONNECTIONS

Connect the unit as in the diagram below.

EXTERNAL DIMENSIONS unit: mm (inch)

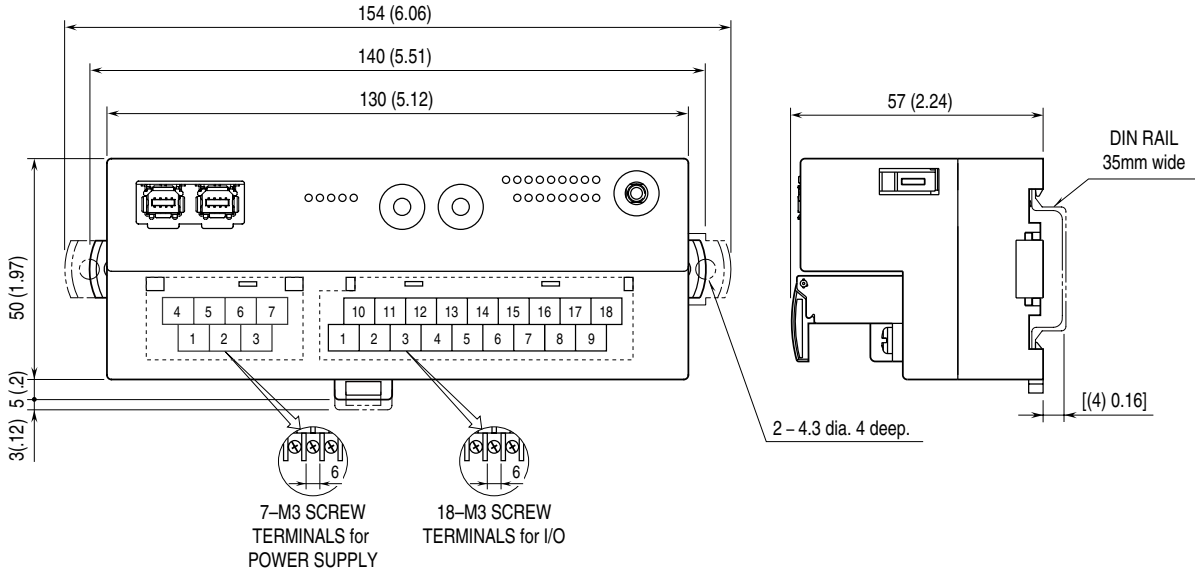

CONNECTION DIAGRAM

Note: In order to improve EMC performance, bond the FE terminal to ground.
 Caution: FE terminal is NOT a protective conductor terminal.

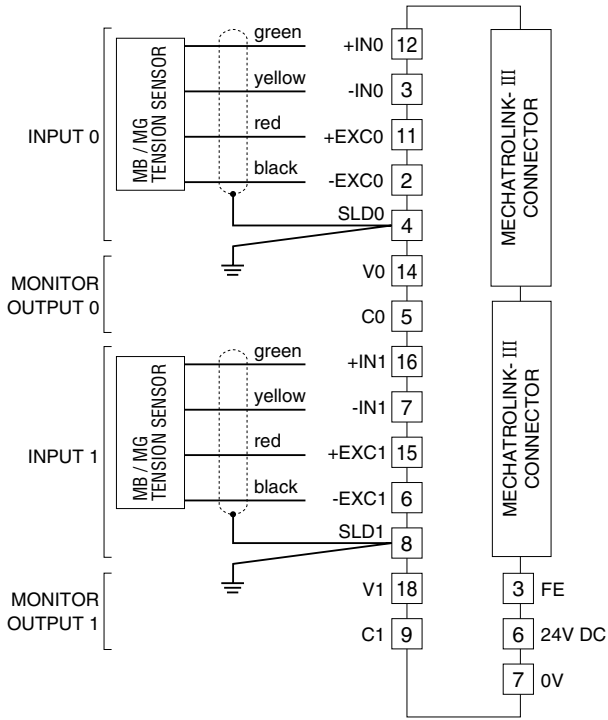

MOUNTING REQUIREMENTS unit: mm (inch)

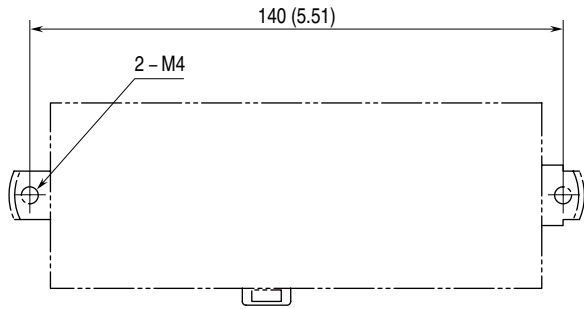

WIRING INSTRUCTIONS

TORQUE

Wiring screw for separable terminal: 0.5 N·m
 Fixing screw for separable terminal: 0.5 N·m

SOLDERLESS TERMINAL

Refer to the drawing below for recommended ring tongue terminal size. Spade tongue type is also applicable.
 Applicable wire size: 0.25 to 1.65 mm² (AWG 22 to 16)
 Recommended manufacturer: Japan Solderless Terminal MFG. Co., Ltd, Nichifu Co., Ltd

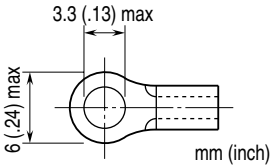

HOW TO UNMOUNT THE SEPARABLE TERMINAL

The separable terminal of the unit is 2 piece constructions. It is possible to remove the terminal by loosening two screws of terminal alternately.

MECHATROLINK-III COMMUNICATION

Transmission cycle: 125 μ sec., 250 μ sec., 500 μ sec., 1 – 64 msec. (with 1 msec. increments)

Communication cycle: 125 μ sec. through 64 msec.

Applicable profile: Standard I/O profile (cyclic communication)

Event-driven communication acquiring ID profile (event-driven communication)

Transmission bytes: 16 bytes

Station address: 03H through EFH (set with rotary switches)

Supported communication mode: Cyclic, Message and Event-driven communication

Message transmission command: 01H, 7FH (Relay level: 3 levels)

Slave monitoring: None

MECHATROLINK-III RELATED COMMANDS

Commands available with this unit are the following.

PROFILE	COMMAND	CODE	FUNCTION
Common command	NOP	00H	No operation command
	ID_RD	03H	Read ID command
	CONFIG	04H	Setup device command
	ALM_RD	05H	Read alarm or warning command
	ALM_CLR	06H	Clear alarm or warning command
	CONNECT	0EH	Establish connection command
	DISCONNECT	0FH	Release connection command
Standard I/O profile	DATA_RWA	20H	Transmit I/O data

• NOP (00H)

Does nothing except sending back current status

BYTE	COMMAND	RESPONSE	REMARKS
0	NOP (00H)	NOP (00H)	No operation command
1	00H	00H	Not used
2	CMD_CTRL	CMD_STAT	Refer to CMD_CTRL/CMD_STAT.
3			
≥ 4	00H	00H	Reserve

• ID_RD (03H)

Reads the product ID.

BYTE	COMMAND	RESPONSE	REMARKS
0	ID_RD (03H)	ID_RD (03H)	Read ID command
1	00H	00H	Not used
2	CMD_CTRL	CMD_STAT	Refer to CMD_CTRL/CMD_STAT.
3			
4	ID_CODE	ID_CODE	Refer to ID_CODE
5	OFFSET	OFFSET	OFFSET: designates the place to read data
6	SIZE	SIZE	SIZE: specify the size of data to read
7			
≥ 8	00H	ID	Product's ID

• CONFIG (04H)

No parameter to set for this unit. Immediately response with completion.

BYTE	COMMAND	RESPONSE	REMARKS
0	CONFIG (04H)	CONFIG (04H)	Setup device command
1	00H	00H	Not used
2	CMD_CTRL	CMD_STAT	Refer to CMD_CTRL/CMD_STAT.
3			
4	00H	00H	Recalculation of parameters and set up. Other than 00H is not supported.
≥ 5	00H	00H	Reserve

• **ALM_RD (05H)**

Reads alarm or warning

BYTE	COMMAND	RESPONSE	REMARKS
0	ALM_RD (05H)	ALM_RD (05H)	Read alarm or warning command
1	00H	00H	Not used
2	CMD_CTRL	CMD_STAT	Refer to CMD_CTRL/CMD_STAT.
3			
4	0000H	0000H	Read current alarm or warning. 12 points max. (2 bytes in 8th to 31st byte) Other than 0000H is not available.
5			
6	0000H	0000H	0
7			
≥ 8	00H	00H	0

• **ALM_CLR (06H)**

Clears alarm or warning

BYTE	COMMAND	RESPONSE	REMARKS
0	ALM_CLR (06H)	ALM_CLR (06H)	Clear alarm or warning command
1	00H	00H	Not used
2	CMD_CTRL	CMD_STAT	Refer to CMD_CTRL/CMD_STAT.
3			
4	0000H	0000H	Clear current alarm or warning. Other than 0000H is not available.
5			
≥ 6	00H	00H	Reserve

• **CONNECT (0EH)**

Starts communication with master station.

BYTE	COMMAND	RESPONSE	REMARKS
0	CONNECT (0EH)	CONNECT (0EH)	Establish connection command
1	00H	00H	Not used
2	CMD_CTRL	CMD_STAT	Refer to CMD_CTRL/CMD_STAT.
3			
4	30H	30H	MECHATROLINK application layer: 30H
5	00H	00H	Communication mode: Asynchronous, single transmission, subcommand disabled
6	COM_TIME	COM_TIME	Communication cycle: Multiple of transmission cycle. E.g. Transmission cycle: 0.5 msec., communication cycle: 2 msec. Set 4 (=2/0.5)
7	30H or 01H	30H or 01H	Profile type 30H: Standard I/O profile 01H: Event-driven communication acquiring ID profile
≥ 8	00H	00H	Reserve

• **DISCONNECT (0FH)**

Stops communication with master station.

BYTE	COMMAND	RESPONSE	REMARKS
0	DISCONNECT (0FH)	DISCONNECT (0FH)	Release connection command
≥ 1	00H	00H	Reserve

• **DATA_RWA (20H)**

Transmits I/O data to master station. Data allocation is following.

Data size is 16 bytes.

BYTE	COMMAND	RESPONSE	REMARKS
0	DATA_RWA (20H)	DATA_RWA (20H)	Transmit I/O data
1	00H	00H	Not used
2	CMD_CTRL	CMD_STAT	Refer to CMD_CTRL/CMD_STAT.
3			
4	00H	TOTAL IN LO	Lower byte of total input *
5	00H	TOTAL IN HI	Upper byte of total input *
6	00H	CH0 IN LO	Lower byte of CH0
7	00H	CH0 IN HI	Upper byte of CH0
8	00H	CH1 IN LO	Lower byte of CH1
9	00H	CH1 IN HI	Upper byte of CH1
10	00H	00H	Not used
11	00H	00H	Not used
12	00H	STATUS LO	Lower byte of R7G4HML3 status
13	00H	STATUS HI	Upper byte of R7G4HML3 status
14	00H	00H	Not used
15	00H	00H	Not used

* Total input data: Sum of input 0 and input 1

MESSAGE TRANSMISSION

Available message transmission command is as follows.

FUNCTION CODE	SUB FUNCTION CODE	DESCRIPTION	REMARKS
42H	01H	Reading memory	Reading virtual memory space
	7FH	Vendor-specific command	Original command

■ READ MEMORY (01H) MESSAGE FORMAT

Command to read data in the virtual memory space.

BYTE	COMMAND	RESPONSE	
		NORMAL	ERROR
0	Slave address	Slave address	Slave address
1	Function code: 42H	Function code: 42H	Function code: C2H
2	00H (Not used)	Extended address	Extended address
3	00H (Not used)	Response status	Response status
4	Sub function code: 01H	Sub function code: 01H	Sub function code: 01H
5	Mode/Data type*1 : 13H	Mode/Data type*1 : 13H	Error code (See error code table)
6	Number of data*2	Number of data*2	Reserve (00H)
7			
8	Initial address	Data	
9		:	
10		:	
11		:	
:		:	
:		:	

*1. Mode: Only 01H (volatile memory) is supported. Data type: 03H (long, 4 Bytes) is supported.

*2. For number of data, specify number of data type.

Max. number of data is as follows. Relay Level 1: 24, Relay Level 2: 22, Relay Level 3: 20.

The virtual memory is defined by three address spaces as shown below.

1. 0000H to 0083H, 2. 00C0H to 011FH 3. 0180H to 019FH

To read out the memory, set address so that initial address and end address are within one of above mentioned address space.

The command, which read address not defined, causes error.

(End address = initial address + (number of data × 4) -1)

Address for readable virtual memory space is as follows.

ADDRESS	DESCRIPTION
0000 0000	Reserve (00000000H)
0000 0004	Vendor ID code
0000 0008	Device code
0000 000C	Device version
0000 0010	Device definition file version
0000 0014	Extended address setting
0000 0018	Serial number (ASCII code)
:	
0000 0037	
0000 0038	Reserve (00000000H)
0000 003C	Reserve (00000000H)
0000 0040	Profile type 1
0000 0044	Profile version 1
0000 0048	Profile type 2
0000 004C	Profile version 2
0000 0050	Profile type 3
0000 0054	Profile version 3
0000 0058	Min. transmission cycle
0000 005C	Max. transmission cycle
0000 0060	Increments of transmission cycle
0000 0064	Min. communication cycle
0000 0068	Max. communication cycle
0000 006C	Transmission bytes
0000 0070	Transmission bytes (current setting)
0000 0074	Profile type (current selection)
0000 0078	Reserve (00000000H)
0000 007C	Reserve (00000000H)
0000 0080	Supported communication mode

ADDRESS	DESCRIPTION
0000 00C0	List of supported main commands
:	
0000 00DF	
0000 00E0	List of supported sub commands
:	
0000 00FF	
0000 0100	List of supported common parameters
:	
0000 011F	
0000 0180	List of supported MECHATROLINK message communication sub function
:	
0000 019F	

■ VENDOR-SPECIFIC COMMAND (7FH) MESSAGE FORMAT

Vendor-specific commands are our independently defined command.

BYTE	COMMAND		RESPONSE	
			NORMAL	ERROR
0	Slave address		Slave address	Slave address
1	Function code: 42H		Function code: 42H	Function code + 80H C2H
2	00H (Not used)		Extended address	Extended address
3	00H (Not used)		Response status	Response status
4	Sub function code: 7FH		Sub function code: 7FH	Sub function code: 7FH
5	00H (Reserve)		00H (Reserve)	Error code (See error code table)
6	Protocol ID	00H	Protocol ID	Protocol ID *1
7		21H		
8	Data length (Byte)		Data length (Byte)	
9				
10				
11				
12	00H		00H (Status flag: normal)	Vendor - specific error code (See vendor-specific error code table)*2
13	Model code (See following table)		Model code	Model code*2
14	Channel designation (See following table)		Channel	Channel*2
15	Command code (See following table)		Command code	Command code*2
16	Set data 1 upper byte		Set data 1 upper byte	
17	Set data 1 lower byte		Set data 1 lower byte	
18	Set data 2 upper byte		Set data 2 upper byte	
19	Set data 2 lower byte		Set data 2 lower byte	
:	:		:	
80	Set data 33 upper byte		Set data 33 upper byte	
81	Set data 33 lower byte		Set data 33 lower byte	

*1. Error code: 0000H when 01H (Function code error).

*2. Error code: Only 83H (vendor-specific area error) is valid.

• MODEL CODE

MODEL CODE	MODEL
03H	R7G4HML3-6-LC2A

• CHANNEL CODE

CHANNEL CODE	CHANNEL
01H	CHANNEL 0
02H	CHANNEL 1

• COMMAND CODE

COMMAND CODE	COMMAND	DESCRIPTION
01H	Automatic zero correction	Reset the current input of a specified channel to 0.
02H	Zero adjustment	Set the current input of a specified channel to a zero point.
03H	Span adjustment	Set the current input of a specified channel to a span point.
04H	Averaging setting	Set the averaging of a specified channel.
05H	Read averaging setting	Read the averaging setting of a specified channel.
06H	Monitor output	Output set data at the set data area of a specified channel from monitor output sensor.
07H	Cancel monitor output	Shift from the monitor output mode to the normal measuring mode.
08H	Reset offset	Reset the offset set by automatic zero correction command to "0"
09H	CR filter setting	Set input CR filter.
0AH	Read CR filter setting	Read CR filter set value.

• COMMAND DETAILS

AUTOMATIC ZERO CORRECTION (01H)

Resets the current input of a specified channel to 0 and returns a response when the offset is completed. Perform automatic zero correction setting after zero/span adjustments.

The following is an example of automatic zero correction command of Input 0.

BYTE	COMMAND	RESPONSE	DESCRIPTION
8	00H	00H	Data length
9	00H	00H	
10	00H	00H	
11	04H	04H	
12	00H	00H	Status flag: normal
13	03H	03H	Model code: R7G4HML3-6-LC2A
14	01H	01H	Channel: Input 0
15	01H	01H	Command code: Automatic zero correction

ZERO ADJUSTMENT (02H)

Sets the current input of a specified channel to a zero point and returns a response when the adjustment is completed.

The following is an example of zero adjustment command of Input 1.

BYTE	COMMAND	RESPONSE	DESCRIPTION
8	00H	00H	Data length
9	00H	00H	
10	00H	00H	
11	04H	04H	
12	00H	00H	Status flag: normal
13	03H	03H	Model code: R7G4HML3-6-LC2A
14	02H	02H	Channel: Input 1
15	02H	02H	Command code: Zero adjustment

SPAN ADJUSTMENT (03H)

Sets the current input of a specified channel to a span point and returns a response when the adjustment is completed.

If necessary, load coefficient can be set at set data 1 in %.

The following is an example of span adjustment command of Input 0 with load coefficient of 20.00% (2000: 07D0H).

BYTE	COMMAND	RESPONSE	DESCRIPTION
8	00H	00H	Data length
9	00H	00H	
10	00H	00H	
11	06H	06H	
12	00H	00H	Status flag: normal
13	03H	03H	Model code: R7G4HML3-6-LC2A
14	01H	01H	Channel: Input 0
15	03H	03H	Command code: Span adjustment
16	07H	07H	Load coefficient upper byte
17	D0H	D0H	Load coefficient lower byte

AVERAGING SETTING (04H)

Sets the averaging of input data and returns a response when the setting is completed.

Averaging can be set to 2, 4, 8, 16, 32, 64, 128, 256, 512 and 1024 samples.

The following is an example of averaging (32 samples (20H)) command of Input 1.

BYTE	COMMAND	RESPONSE	DESCRIPTION
8	00H	00H	Data length
9	00H	00H	
10	00H	00H	
11	06H	06H	
12	00H	00H	Status flag: normal
13	03H	03H	Model code: R7G4HML3-6-LC2A
14	02H	02H	Channel: Input 1
15	04H	04H	Command code: Set averaging number
16	00H	00H	Averaging upper byte
17	20H	20H	Averaging lower byte

READ AVERAGING SETTING (05H)

Reads the averaging setting.

The following is an example of read averaging setting command of Input 0.

BYTE	COMMAND	RESPONSE	DESCRIPTION
8	00H	00H	Data length
9	00H	00H	
10	00H	00H	
11	04H	06H	
12	00H	00H	Status flag: normal
13	03H	03H	Model code: R7G4HML3-6-LC2A
14	01H	01H	Channel: Input 0
15	05H	05H	Command code: Read averaging number
16	Not used	00H	Averaging upper byte
17	Not used	20H	Averaging lower byte

MONITOR OUTPUT (06H)

Outputs set data at set data 1 from output terminal of a specified channel.

The following is an example of 50.00% (5000: 1388H) monitor output command of Input 1.

BYTE	COMMAND	RESPONSE	DESCRIPTION
8	00H	00H	Data length
9	00H	00H	
10	00H	00H	
11	06H	06H	
12	00H	00H	Status flag: normal
13	03H	03H	Model code: R7G4HML3-6-LC2A
14	02H	02H	Channel: Input 1
15	06H	06H	Command code: Monitor output
16	13H	13H	Monitor output data upper byte
17	88H	88H	Monitor output data lower byte

CANCEL MONITOR OUTPUT (07H)

Returns a specified channel from monitor output mode to measuring mode.

The following is an example of command to cancel monitor output mode of Input 0.

BYTE	COMMAND	RESPONSE	DESCRIPTION
8	00H	00H	Data length
9	00H	00H	
10	00H	00H	
11	04H	04H	
12	00H	00H	Status flag: normal
13	03H	03H	Model code: R7G4HML3-6-LC2A
14	01H	01H	Channel: Input 0
15	07H	07H	Command code: Cancel monitor output

RESET OFFSET (08H)

Resets the offset value of a specified channel.

The following is an example of command to reset offset value of Input 1 to 0.

BYTE	COMMAND	RESPONSE	DESCRIPTION
8	00H	00H	Data length
9	00H	00H	
10	00H	00H	
11	04H	04H	
12	00H	00H	Status flag: normal
13	03H	03H	Model code: R7G4HML3-6-LC2A
14	02H	02H	Channel: Input 1
15	08H	08H	Command code: Reset offset

CR FILTER SETTING (09H)

Sets input CR filter to either 2 Hz or 2 kHz.

CR filter set value: 0 (2 Hz)

CR filter set value: 1 (2 kHz)

The following is an example of command to set input CR filter to 0 (2 Hz).

BYTE	COMMAND	RESPONSE	DESCRIPTION
8	00H	00H	Data length
9	00H	00H	
10	00H	00H	
11	06H	06H	
12	00H	00H	Status flag: normal
13	03H	03H	Model code: R7G4HML3-6-LC2A
14	01H	01H	01H (fixed)
15	09H	09H	Command code: CR Filter setting
16	00H	00H	CR filter set value: 0 (2 Hz)
17	00H	00H	

READ CR FILTER SETTING (0AH)

Reads CR filter set value.

The following is an example of command to read a CR filter set value.

BYTE	COMMAND	RESPONSE	DESCRIPTION
8	00H	00H	Data length
9	00H	00H	
10	00H	00H	
11	04H	06H	
12	00H	00H	Status flag: normal
13	03H	03H	Model code: R7G4HML3-6-LC2A
14	01H	01H	Channel: Input 0
15	0AH	0AH	Command code: Read CR filter setting
16	Not used	00H	CR filter set value: 1 (2 kHz)
17	Not used	01H	

• ERROR CODE

ERROR CODE	DESCRIPTION	DETAIL
01H	Function code error	Non supported function code or sub function code.
03H	Wrong number	Differ from data length of command.
04H	Data type error	Not supported to specified mode or data type.
09H	Process conflict error	Cannot process due to during processing.
81H	Protocol ID setting error	Protocol ID does not match connected device during vendor-specific command is executed.
82H	Data length setting error	Setting of data length for vendor-specific area does not match connected device during vendor-specific command is executed.
83H	Vendor-specified area error	Vendor-specific error (refer to table below) occurred in the vendor-specific area during vendor-specific command is executed.

• VENDOR - SPECIFIC ERROR CODE

ERROR CODE	DESCRIPTION	DETAIL
01H	Device code error	Specified device code differs from connected device.
02H	Specified channel error	Specified channel is not supported by connected device.
03H	Specified command error	Specified command is not supported by connected device.
04H	Specified command data error	Data error of specified command.

CMD_CTRL

CMD_CTRL command area is following.

BIT	FUNCTION	REMARKS
0 – 2	Reserve	Not used
3	ALM_CLR	0: Clear alarm/warning disabled 1: Clear alarm/warning triggered
4 – 5	Reserve	Not used
6 – 7	CMD_ID	Not used in the standard I/O command profile
8 – 15	Reserve	Not used

CMD_STAT

CMD_STAT response area is following.

BIT	FUNCTION	REMARKS	
0	D_ALM	Not used	
1	D_WAR	Not used	
2	CMDRDY	1: Command reception enabled 0: Other	
3	ALM_CLR_CMP	1: Completion of execution of ALM_CLR 0: Other ALM_CLR_CMP can be canceled by setting '0' for ALM_CLR in CMD_CTRL command area.	
4 – 5	Reserve	Not used	
6 – 7	RCMD_ID	Not used in the standard I/O command profile	
8 – 11	CMD_ALM	Warning	0: Normal, 1: Invalid data
		Alarm	8: Unsupported command received, 9: Invalid data, A: Command execution condition error, B: Subcommand combination error, C: Phase error
12 – 15	COMM_ALM	Warning	0: Normal, 1: FCS error, 2: Command data not received, 3: Synchronous frame not received
		Alarm	8: FCS error, 9: Command data not received, A: Synchronous frame not received, B: Synchronization time interval error, C: WDT error

ID_CODE

ID_CODE is following.

ID_CODE	NAME	SIZE (BYTES)	SUPPORT	VALUE (HEXADECIMAL)	REMARKS
01H	Vendor ID Code	4	Yes	0x00000021	M-SYSTEM CO., LTD.
02H	Device Code	4	Yes	0x00000210	R7G4HML3-6-LC2A
03H	Device Version	4	Yes	Firmware version	E.g. 1.00 -> 0x0064
04H	Device Definition File version	4	Yes	0x00001000	
05H	Extended Address Setting	4	Yes	0x00000001	
06H	Serial No.	32	Yes	Unit serial number	E.g. AB123456 -> 0x32314241 0x36353433 0x00000000 0x00000000 0x00000000 0x00000000 0x00000000 0x00000000
10H	Profile Type 1	4	Yes	0x00000030	Standard I/O profile
11H	Profile Version 1	4	Yes	0x00000100	
12H	Profile Type 2	4	Yes	0x000000FF	Indicates the unit does not support
13H	Profile Version 2	4	Yes	0x00000000	
14H	Profile Type 3	4	Yes	0x000000FF	Indicates the unit does not support
15H	Profile Version 3	4	Yes	0x00000000	
16H	Min. Transmission Cycle	4	Yes	0x000030D4	125 μ sec.
17H	Max. Transmission Cycle	4	Yes	0x0061A800	64 msec.
18H	Increments of Transmission Cycle	4	Yes	0x00000001	Available to 31.25, 62.5, 125, 250, 500 [μ sec.] & 1 – 64 [msec.] (1 msec. increments)
19H	Min. Communication Cycle	4	Yes	0x000030D4	125 μ sec.
1AH	Max. Communication Cycle	4	Yes	0x0061A800	64 msec.
1BH	Transmission Bytes	4	Yes	0x00000002	16 Bytes
1CH	Transmission Bytes (Current Setting)	4	Yes	0x00000002	16 Bytes
1DH	Profile Type (Current Selection)	4	Yes	0x00000001 / 0x00000030	Event-driven communication / Cyclic communication
20H	Supported Communication Mode	4	Yes	0x00000003	Event-driven communication / Cyclic communication
21H	MAC Address	4	No	----	
30H	List of Supported Main Commands	32	Yes	0x0000C079 0x00000001 0x00000000 0x00000000 0x00000000 0x00000000 0x00000000 0x00000000	ALM_CLR, ALM_RD, CONFIG, ID_RD, NOP, DISCONNECT, CONNECT, DATA_RWA
38H	List of Supported Sub Commands	32	No	----	
40H	List of Common Parameters	32	No	----	
80H	Main Device Name	32	Yes	0x34473752 0x334C4D48 0x4C2D362D 0x00413243 0x00000000 0x00000000 0x00000000 0x00000000	“R7G4HML3-6-LC2A”
90H	Sub Device 1 Name	4	No	----	
98H	Sub Device 1 Version	32	No	----	
A0H	Sub Device 2 Name	4	No	----	
A8H	Sub Device 2 Version	32	No	----	
B0H	Sub Device 3 Name	4	No	----	
B8H	Sub Device 3 Version	32	No	----	

I/O DATA DESCRIPTION

■ ANALOG I/O MODULE

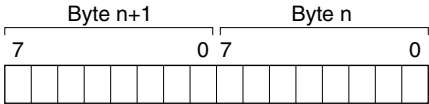

Data is represented in 16-bit binary. Negative value is represented in 2's complements.

■ STATUS

