

MECHATROLINK I/O MODULE

(high-speed DC voltage output, 4 points, isolated, screw terminal block, MECHATROLINK-III use)

MODEL R7G4HML3-6-YVF4**BEFORE USE**

Thank you for choosing us. Before use, please check contents of the package you received as outlined below. If you have any problems or questions with the product, please contact our sales office or representatives.

The unit is for use in general industrial environments, therefore may not be suitable for applications which require higher level of safety (e.g. safety or accident prevention systems) or of reliability (e.g. vehicle control or combustion control systems).

For safety, installation and maintenance of this unit must be conducted by qualified personnel.

■ PACKAGE INCLUDES:

High-speed DC voltage output module(1)
DIN rail mounter slider(2)

■ MODEL NO.

Confirm Model No. marking on the product to be exactly what you ordered.

■ INSTRUCTION MANUAL

This manual describes necessary points of caution when you use this product, including installation, connection and basic maintenance procedures.

■ SYMBOLS USED ON THE PRODUCT

Functional earth symbol is marked on terminal cover of Power Supply Terminals for UL.

POINTS OF CAUTION**■ CAUTION**

- If the unit is used in a manner not specified by this manual, the protection provided by the equipment may be impaired.

■ CONFORMITY WITH EU DIRECTIVES OR UL

- The equipment must be mounted inside the instrument panel of a metal enclosure.
- The actual installation environments such as panel configurations, connected devices, connected wires, may affect the protection level of this unit when it is integrated in a panel system. The user may have to review the CE requirements in regard to the whole system and employ additional protective measures* to ensure the CE conformity.
* For example, installation of noise filters and clamp filters for the power source, input and output connected to the unit, etc.
- This unit is suitable for Pollution Degree 2.
- Altitude up to 2000 meters.
- The power supply and the external power supply must satisfy SELV requirements in accordance with the currently applicable safety standards. (SELV = Safety Extra Low Voltage).

- Install inside an industrial control panel or equivalent for UL.

■ POWER INPUT RATING & OPERATIONAL RANGE

- Locate the power input rating marked on the product and confirm its operational range as indicated below:
24V DC rating: 24V ±10%, approx. 100mA

■ GENERAL PRECAUTIONS

- Before you remove the unit or mount it, turn off the power supply and output signal for safety.
- Before you remove the terminal block or mount it, make sure to turn off the power supply and output signal for safety.

■ ENVIRONMENT

- Indoor use.
- When heavy dust or metal particles are present in the air, install the unit inside proper housing with sufficient ventilation.
- Do not install the unit where it is subjected to continuous vibration. Do not subject the unit to physical impact.
- Environmental temperature must be within -10 to +55°C (14 to 131°F) with relative humidity within 30 to 90% RH in order to ensure adequate life span and operation.

■ WIRING

- Do not install cables close to noise sources (relay drive cable, high frequency line, etc.).
- Do not bind these cables together with those in which noises are present. Do not install them in the same duct.
- Be sure to close the terminal cover for safety.

■ AND

- The unit is designed to function as soon as power is supplied, however, a warm up for 10 minutes is required for satisfying complete performance described in the data sheet.

COMPONENT IDENTIFICATION

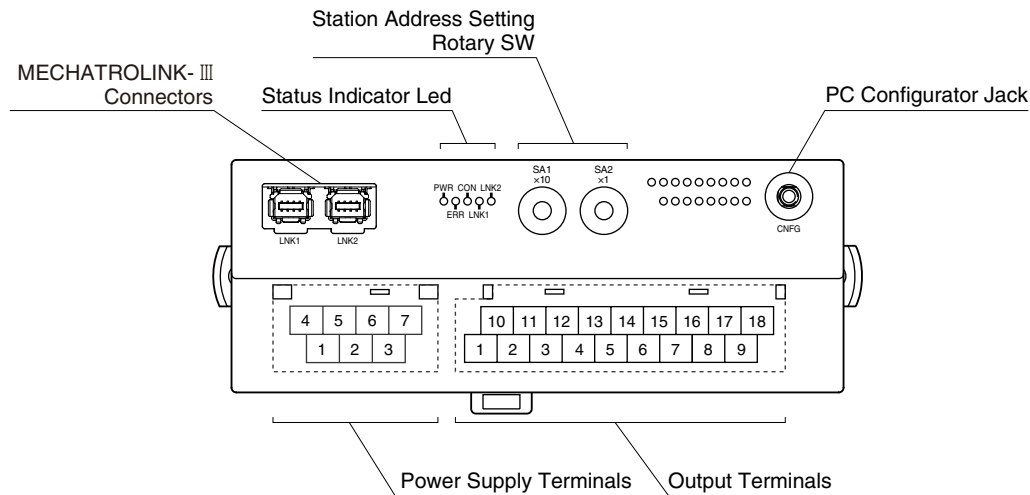

■ STATUS INDICATOR LED

ID	COLOR	FUNCTION
PWR	Green	Turns on when the internal power is supplied normally.
ERR	Red	Turns on at MECHATROLINK-III communication error
CON	Green	Turns on at MECHATROLINK-III connection is established
LNK1	Green	Turns on at MECHATROLINK-III LNK1 is established
LNK2	Green	Turns on at MECHATROLINK-III LNK2 is established

■ STATION ADDRESS

Station Address is selected between 03H and EFH in hexadecimal.

The SA1 switch determines the MSD, while the SA2 switch does the LSD of the address.

(Factory setting: 03H)

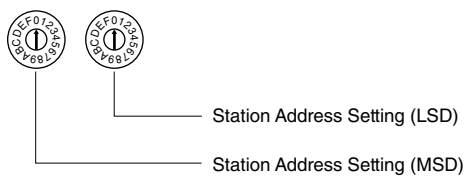

■ POWER SUPPLY TERMINAL ASSIGNMENT

4	5	6	7
NC	NC	+24V	0V
1	2	3	
NC	NC	FE	

- | | |
|---------|-----------------------|
| 1. NC | - |
| 2. NC | - |
| 3. FE | Functional earth |
| 4. NC | - |
| 5. NC | - |
| 6. +24V | Power supply (24V DC) |
| 7. 0V | Power supply (0V) |

■ OUTPUT TERMINAL ASSIGNMENT

10	11	12	13	14	15	16	17	18
NC	VH0	NC	VH1	NC	VH2	NC	VH3	NC
1	2	3	4	5	6	7	8	9
NC	COM0	VL0	COM1	VL1	COM2	VL2	COM3	VL3

NO.	ID	FUNCTION	NO.	ID	FUNCTION
1	NC	No connection	10	NC	No connection
2	COM0	Common 0	11	VH0	Wide span volt. 0
3	VL0	Narrow span volt. 0	12	NC	No connection
4	COM1	Common 1	13	VH1	Wide span volt. 1
5	VL1	Narrow span volt. 1	14	NC	No connection
6	COM2	Common 2	15	VH2	Wide span volt. 2
7	VL2	Narrow span volt. 2	16	NC	No connection
8	COM3	Common 3	17	VH3	Wide span volt. 3
9	VL3	Narrow span volt. 3	18	NC	No connection

OUTPUT RANGE

- **Wide span:** -10 – +10V DC, -5 – +5V DC, 0 – 10V DC, 0 – 5V DC, 1 – 5V DC
- **Narrow span:** -1 – +1V DC, 0 – 1V, -0.5 – +0.5V DC

PC CONFIGURATOR

The following parameter items can be set with using PC Configurator Software (model: R7CFG). Refer to the users manual for the R7CFG for detailed operation of the software program.

■ CHANNEL INDIVIDUAL SETTING

PARAMETER	SETTING RANGE	DEFAULT SETTING
Validating/Invalidating	Valid Invalid	Valid
Output range	-10 to +10V DC -5 to +5V DC -1 to +1V DC 0 to 10V DC 0 to 5V DC 1 to 5V DC 0 to 1V DC -0.5 to +0.5V DC	-10 to +10V DC
Bias	-320.00 to +320.00 (%)	0.00 (%)
Gain	-3.2000 to +3.2000	1.0000
Zero scale	-32 000 to +32 000	0
Full scale	-32 000 to +32 000	10 000
Output clear value*1	-15.00 to +115.00 (%)	-15.00 (%)

■ CHANNEL BATCH SETTING

PARAMETER	SETTING RANGE	DEFAULT SETTING
Output at the loss of communication	Hold Clear	Hold

*1. When output range is -10 to +10V DC, approx. -11.5V DC at approx. -7.5 to -15% and approx. 11.5V DC at approx. 107.5 to 115% are outputted respectively.

MOUNTING INSTRUCTIONS

■ DIN RAIL MOUNTING (PARALLEL)

• Mounting

- 1) Set the upper hook at the rear side of the unit on the DIN rail.
- 2) Push in the lower.

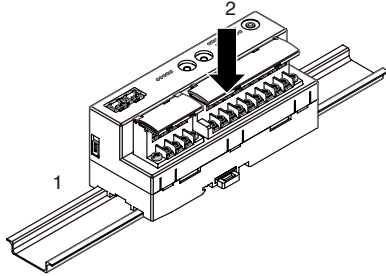

• Dismounting

- 1) Push down the DIN rail mounter slider with tip of a minus screwdriver.
- 2) Pull the lower of the unit.
- 3) Remove the upper hook of the unit from the DIN rail.

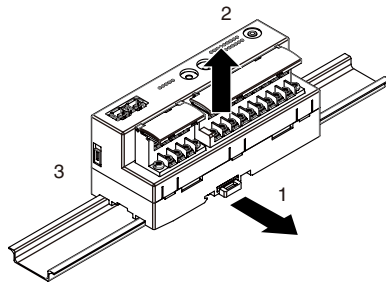

■ DIN RAIL MOUNTING (RIGHT ANGLE)

• Mounting

- 1) Insert the longer DIN rail mounter slider until it clicks twice, as shown below.

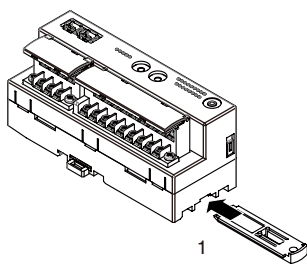

- 2) Set the upper hook at the rear side of the unit on the DIN rail.
- 3) Push in the lower.

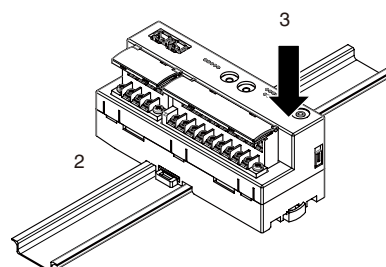

• Dismounting

- 1) Push down the DIN rail mounter slider with tip of a minus screwdriver.
- 2) Pull the lower of the unit.
- 3) Remove the upper hook of the unit from the DIN rail.

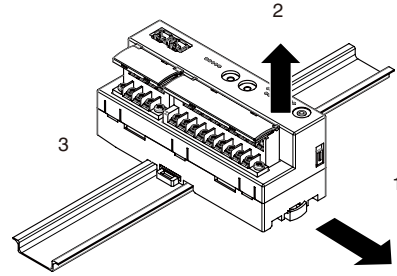

■ SURFACE MOUNTING

- 1) Insert the two DIN rail mounter sliders until it clicks once, as shown below.

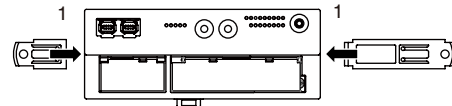

- 2) Mount the unit with M4 screws referring the External Dimensions. (Torque: 1.4 N·m)

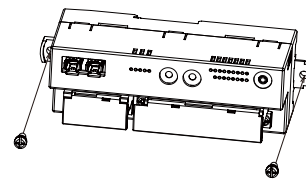

TERMINAL CONNECTIONS

Connect the unit as in the diagram below.

EXTERNAL DIMENSIONS unit: mm (inch)

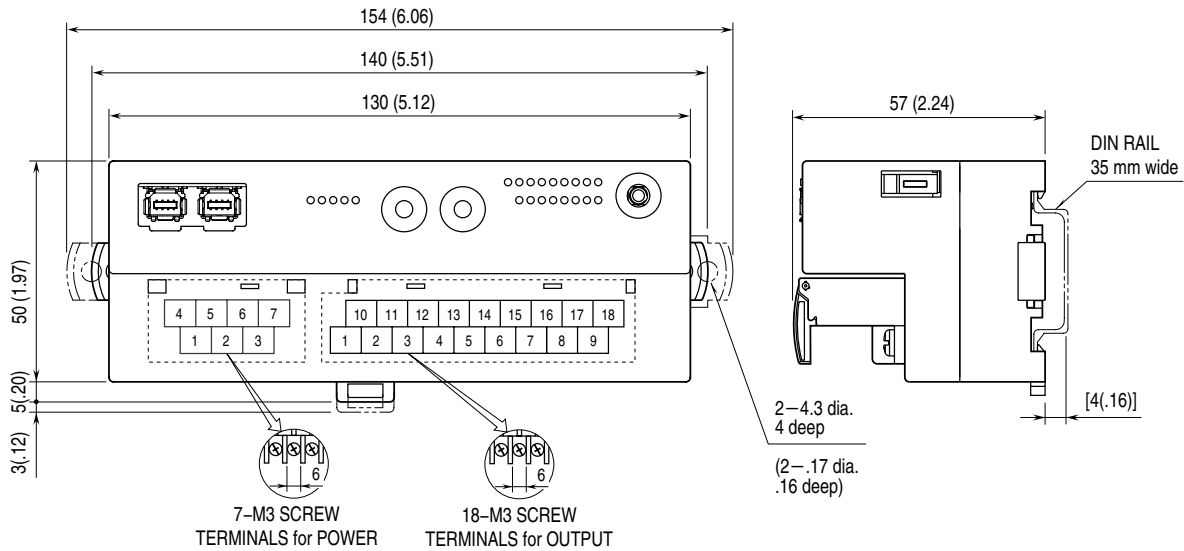

CONNECTION DIAGRAM

Note: In order to improve EMC performance, bond the FE terminal to ground.

Caution: FE terminal is NOT a protective conductor terminal.

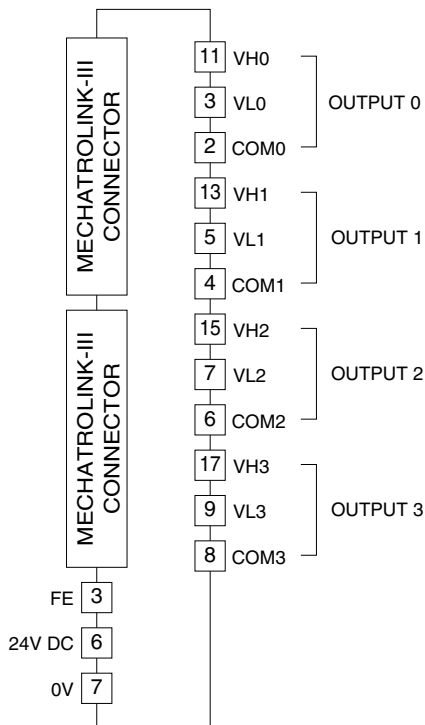

MOUNTING REQUIREMENTS unit: mm (inch)

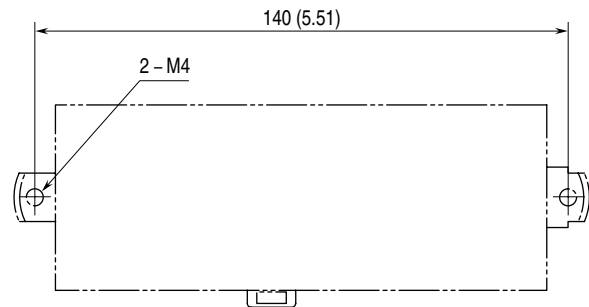

WIRING INSTRUCTIONS

TORQUE

Wiring screw for separable terminal: 0.5 N·m

Fixing screw for separable terminal: 0.5 N·m

SOLDERLESS TERMINAL

Refer to the drawing below for recommended ring tongue terminal size. Spade tongue type is also applicable.

Applicable wire size: 0.25 to 1.65 mm² (AWG 22 to 16)

Recommended manufacturer: Japan Solderless Terminal MFG. Co., Ltd, Nichifu Co., Ltd

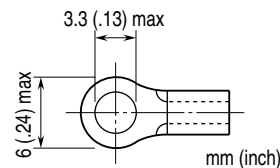

HOW TO UNMOUNT THE SEPARABLE TERMINAL

The separable terminal of the unit is 2 piece constructions. It is possible to remove the terminal by loosening two screws of terminal alternately.

MECHATROLINK-III COMMUNICATION

Transmission cycle: 125 μ sec., 250 μ sec., 500 μ sec., 1 – 64 msec. (with 1 msec. increments)

Communication cycle: 125 μ sec. through 64 msec.

Applicable profile: Standard I/O profile (cyclic communication)

Event-driven communication acquiring ID profile (event-driven communication)

Transmission bytes: 16 bytes

Station address: 03H through EFH (set with rotary switches)

Cyclic communication: Available

Event-driven communication: Available

Slave monitoring: None

MECHATROLINK-III RELATED COMMANDS

Commands available with this unit are the following.

PROFILE	COMMAND	CODE	FUNCTION
Common command	NOP	00H	No operation command
	ID_RD	03H	Read ID command
	CONFIG	04H	Setup device command
	ALM_RD	05H	Read alarm or warning command
	ALM_CLR	06H	Clear alarm or warning command
	CONNECT	0EH	Establish connection command
	DISCONNECT	0FH	Release connection command
Standard I/O profile	DATA_RWA	20H	Transmit I/O data

• NOP (00H)

Does nothing except sending back current status

BYTE	COMMAND	RESPONSE	REMARKS
0	NOP (00H)	NOP (00H)	No operation command
1	00H	00H	Not used
2	CMD_CTRL	CMD_STAT	Refer to CMD_CTRL/CMD_STAT.
3			
≥ 4	00H	00H	Reserve

• ID_RD (03H)

Reads the product ID.

BYTE	COMMAND	RESPONSE	REMARKS
0	ID_RD (03H)	ID_RD (03H)	Read ID command
1	00H	00H	Not used
2	CMD_CTRL	CMD_STAT	Refer to CMD_CTRL/CMD_STAT.
3			
4	ID_CODE	ID_CODE	Refer to ID_CODE
5	OFFSET	OFFSET	OFFSET: designates the place to read data
6	SIZE	SIZE	SIZE: specify the size of data to read
7			
≥ 8	00H	ID	Product's ID

• CONFIG (04H)

No parameter to set for this unit. Immediately response with completion.

BYTE	COMMAND	RESPONSE	REMARKS
0	CONFIG (04H)	CONFIG (04H)	Setup device command
1	00H	00H	Not used
2	CMD_CTRL	CMD_STAT	Refer to CMD_CTRL/CMD_STAT.
3			
4	00H	00H	Recalculation of parameters and set up. Other than 00H is not supported.
≥ 5	00H	00H	Reserve

• **ALM_RD (05H)**

Reads alarm or warning

BYTE	COMMAND	RESPONSE	REMARKS
0	ALM_RD (05H)	ALM_RD (05H)	Read alarm or warning command
1	00H	00H	Not used
2	CMD_CTRL	CMD_STAT	Refer to CMD_CTRL/CMD_STAT.
3			
4	0000H	0000H	Read current alarm or warning. 12 points max. (2 bytes in 8th to 31st byte) Other than 0000H is not available.
5			
6	0000H	0000H	0
7			
≥ 8	00H	00H	0

• **ALM_CLR (06H)**

Clears alarm or warning

BYTE	COMMAND	RESPONSE	REMARKS
0	ALM_CLR (06H)	ALM_CLR (06H)	Clear alarm or warning command
1	00H	00H	Not used
2	CMD_CTRL	CMD_STAT	Refer to CMD_CTRL/CMD_STAT.
3			
4	0000H	0000H	Clear current alarm or warning. Other than 0000H is not available.
5			
≥ 6	00H	00H	Reserve

• **CONNECT (0EH)**

Starts communication with master station.

BYTE	COMMAND	RESPONSE	REMARKS
0	CONNECT (0EH)	CONNECT (0EH)	Establish connection command
1	00H	00H	Not used
2	CMD_CTRL	CMD_STAT	Refer to CMD_CTRL/CMD_STAT.
3			
4	30H	30H	MECHATROLINK application layer: 30H
5	00H	00H	Communication mode: Asynchronous, single transmission, subcommand disabled
6	COM_TIME	COM_TIME	Communication cycle: Multiple of transmission cycle. E.g. Transmission cycle: 0.5 msec., communication cycle: 2 msec. Set 4 (=2/0.5)
7	30H or 01H	30H or 01H	Profile type 30H: Standard I/O profile 01H: Event-driven communication acquiring ID profile
≥ 8	00H	00H	Reserve

• **DISCONNECT (0FH)**

Stops communication with master station.

BYTE	COMMAND	RESPONSE	REMARKS
0	DISCONNECT (0FH)	DISCONNECT (0FH)	Release connection command
≥ 1	00H	00H	Reserve

• DATA_RWA (20H)

Transmits I/O data to master station. Data allocation is following.

Data size is 16 bytes.

BYTE	COMMAND	RESPONSE	REMARKS
0	DATA_RWA (20H)	DATA_RWA (20H)	Transmit I/O data
1	00H	00H	Not used
2	CMD_CTRL	CMD_STAT	Refer to CMD_CTRL/CMD_STAT.
3			
4	CH0 OUT LO	CH0 OUT LO (READ BACK)	Lower byte of CH0
5	CH0 OUT HI	CH0 OUT HI (READ BACK)	Upper byte of CH0
6	CH1 OUT LO	CH1 OUT LO (READ BACK)	Lower byte of CH1
7	CH1 OUT HI	CH1 OUT HI (READ BACK)	Upper byte of CH1
8	CH2 OUT LO	CH2 OUT LO (READ BACK)	Lower byte of CH2
9	CH2 OUT HI	CH2 OUT HI (READ BACK)	Upper byte of CH2
10	CH3 OUT LO	CH3 OUT LO (READ BACK)	Lower byte of CH3
11	CH3 OUT HI	CH3 OUT HI (READ BACK)	Upper byte of CH3
12	00H	STATUS LO	Lower byte of R7G4HML3 status
13	00H	STATUS HI	Upper byte of R7G4HML3 status
14	00H	00H	Not used
15	00H	00H	Not used

CMD_CTRL

CMD_CTRL command area is following.

BIT	FUNCTION	REMARKS
0 – 2	Reserve	Not used
3	ALM_CLR	0: Clear alarm/warning disabled 1: Clear alarm/warning triggered
4 – 5	Reserve	Not used
6 – 7	CMD_ID	Not used in the standard I/O command profile
8 – 15	Reserve	Not used

CMD_STAT

CMD_STAT response area is following.

BIT	FUNCTION	REMARKS	
0	D_ALM	Not used	
1	D_WAR	Not used	
2	CMDRDY	1: Command reception enabled 0: Other	
3	ALM_CLR_CMP	1: Completion of execution of ALM_CLR 0: Other ALM_CLR_CMP can be canceled by setting '0' for ALM_CLR in CMD_CTRL command area.	
4 – 5	Reserve	Not used	
6 – 7	RCMD_ID	Not used in the standard I/O command profile	
8 – 11	CMD_ALM	Warning	0: Normal, 1: Invalid data
		Alarm	8: Unsupported command received, 9: Invalid data, A: Command execution condition error, B: Subcommand combination error, C: Phase error
12 – 15	COMM_ALM	Warning	0: Normal, 1: FCS error, 2: Command data not received, 3: Synchronous frame not received
		Alarm	8: FCS error, 9: Command data not received, A: Synchronous frame not received, B: Synchronization time interval error, C: WDT error

ID_CODE

ID_CODE is following.

ID_CODE	NAME	SIZE (BYTES)	SUPPORT	VALUE (HEXADECIMAL)	REMARKS
01H	Vendor ID Code	4	Yes	0x00000021	M-SYSTEM CO., LTD.
02H	Device Code	4	Yes	0x0000020C	R7G4HML3-6-YVF4
03H	Device Version	4	Yes	Firmware version	E.g. 1.00 -> 0x0064
04H	Device Definition File version	4	Yes	0x00001000	
05H	Extended Address Setting	4	Yes	0x00000001	
06H	Serial No.	32	Yes	Unit serial number	E.g. AB123456 -> 0x32314241 0x36353433 0x00000000 0x00000000 0x00000000 0x00000000 0x00000000 0x00000000
10H	Profile Type 1	4	Yes	0x00000030	Standard I/O profile
11H	Profile Version 1	4	Yes	0x00000100	
12H	Profile Type 2	4	Yes	0x000000FF	Indicates the unit does not support
13H	Profile Version 2	4	Yes	0x00000000	
14H	Profile Type 3	4	Yes	0x000000FF	Indicates the unit does not support
15H	Profile Version 3	4	Yes	0x00000000	
16H	Min. Transmission Cycle	4	Yes	0x000030D4	125 μsec.
17H	Max. Transmission Cycle	4	Yes	0x0061A800	64 msec.
18H	Increments of Transmission Cycle	4	Yes	0x00000001	Available to 31.25, 62.5, 125, 250, 500 [μsec.] & 1 – 64 [msec.] (1 msec. increments)
19H	Min. Communication Cycle	4	Yes	0x000030D4	125 μsec.
1AH	Max. Communication Cycle	4	Yes	0x0061A800	64 msec.
1BH	Transmission Bytes	4	Yes	0x00000002	16 Bytes
1CH	Transmission Bytes (Current Setting)	4	Yes	0x00000002	16 Bytes
1DH	Profile Type (Current Selection)	4	Yes	0x00000001 / 0x00000030	Event-driven communication / Cyclic communication
20H	Supported Communication Mode	4	Yes	0x00000003	Event-driven communication / Cyclic communication
21H	MAC Address	4	No	----	
30H	List of Supported Main Commands	32	Yes	0x0000C079 0x00000001 0x00000000 0x00000000 0x00000000 0x00000000 0x00000000 0x00000000	ALM_CLR, ALM_RD, CONFIG, ID_RD, NOP, DISCONNECT, CONNECT, DATA_RWA
38H	List of Supported Sub Commands	32	No	----	
40H	List of Common Parameters	32	No	----	
80H	Main Device Name	32	Yes	0x34473752 0x334C4D48 0x592D362D 0x00344656 0x00000000 0x00000000 0x00000000 0x00000000	“R7G4HML3-6-YVF4”
90H	Sub Device 1 Name	4	No	----	
98H	Sub Device 1 Version	32	No	----	
A0H	Sub Device 2 Name	4	No	----	
A8H	Sub Device 2 Version	32	No	----	
B0H	Sub Device 3 Name	4	No	----	
B8H	Sub Device 3 Version	32	No	----	

I/O DATA DESCRIPTION

■ ANALOG OUTPUT MODULE

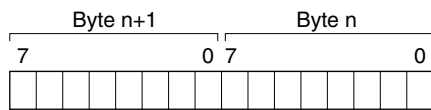

Data is represented in 16-bit binary. Negative value is represented in 2's complements.

■ STATUS

