

MECHATROLINK I/O MODULE
(high-speed DC voltage output, 4 points, isolated,
screw terminal block, MECHATROLINK-I/-II)MODEL **R7G4HML-6-YVF4****BEFORE USE**

Thank you for choosing us. Before use, please check contents of the package you received as outlined below.

If you have any problems or questions with the product, please contact our sales office or representatives.

■ PACKAGE INCLUDES:

High-speed DC voltage output module(1)
DIN rail mounter slider(2)

■ MODEL NO.

Confirm Model No. marking on the product to be exactly what you ordered.

■ INSTRUCTION MANUAL

This manual describes necessary points of caution when you use this product, including installation, connection and basic maintenance procedures.

POINTS OF CAUTION**■ CONFORMITY WITH EU DIRECTIVES**

- The equipment must be mounted inside the instrument panel of a metal enclosure.
- The actual installation environments such as panel configurations, connected devices, connected wires, may affect the protection level of this unit when it is integrated in a panel system. The user may have to review the CE requirements in regard to the whole system and employ additional protective measures to ensure the CE conformity.

■ POWER INPUT RATING & OPERATIONAL RANGE

- Locate the power input rating marked on the product and confirm its operational range as indicated below:
24V DC rating: 24V \pm 10%, approx. 100mA

■ GENERAL PRECAUTIONS

- Before you remove the unit or mount it, turn off the power supply and output signal for safety.
- Before you remove the terminal block or mount it, make sure to turn off the power supply and output signal for safety.
- DO NOT set the switches on the module while the power is supplied. The switches are used only for maintenance without the power.

■ ENVIRONMENT

- Indoor use.
- When heavy dust or metal particles are present in the air, install the unit inside proper housing with sufficient ventilation.
- Do not install the unit where it is subjected to continuous vibration. Do not subject the unit to physical impact.
- Environmental temperature must be within 0 to 55°C (32 to 131°F) with relative humidity within 30 to 90% RH in order to ensure adequate life span and operation.

■ WIRING

- Do not install cables close to noise sources (relay drive cable, high frequency line, etc.).
- Do not bind these cables together with those in which noises are present. Do not install them in the same duct.
- Be sure to close the terminal cover for safety.

■ AND

- The unit is designed to function as soon as power is supplied, however, a warm up for 10 minutes is required for satisfying complete performance described in the data sheet.

COMPONENT IDENTIFICATION

■ TOP VIEW

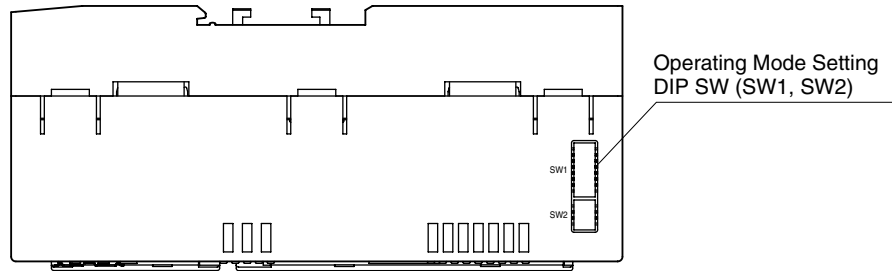

■ FRONT VIEW

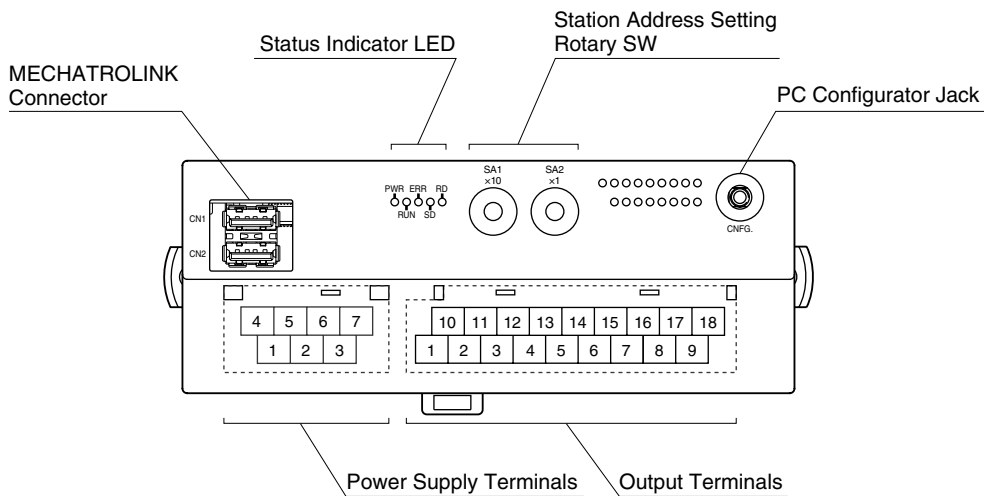

■ STATUS INDICATOR LED

ID	COLOR	FUNCTION
PWR	Green	Turns on when the internal power is supplied normally.
RUN	Green	Turns on in normal communications conditions.
ERR	Red	Turns on in no communication or setting error.
SD	Green	Turns on when the module is transmitting.
RD	Green	Turns on when the module is receiving.

■ STATION ADDRESS

Station Address is selected between 60H and 7FH (Intelligent I/O) in hexadecimal.

The left switch and the right switch determine the MSD and the LSD of the address, respectively.

(Factory setting: 61H)

Certain numbers may not be selectable depending on the master types.

Refer to the instruction manual of the master unit for detail.

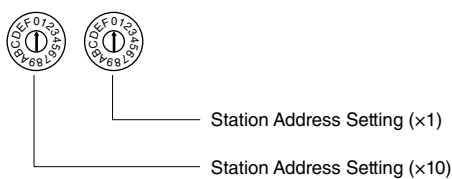

■ OPERATING MODE

(*) Factory setting

• Output at the loss of communication: SW1-4

SW1-4	OUTPUT AT THE LOSS OF COMMUNICATION
OFF	Hold the output (*) (Hold the last received normal data)
ON	Output reset value (Output is fixed to the output reset value)

• Output range: SW1-5, 1-6, 1-7, 1-8

SW1-5	SW1-6	SW1-7	SW1-8	OUTPUT RANGE
OFF	OFF	OFF	OFF	-10 – +10V DC (*)
ON	OFF	OFF	OFF	-5 – +5V DC
OFF	ON	OFF	OFF	-1 – +1V DC
ON	ON	OFF	OFF	0 – 10V DC
OFF	OFF	ON	OFF	0 – 5V DC
ON	OFF	ON	OFF	1 – 5V DC
OFF	ON	ON	OFF	0 – 1V DC
ON	ON	ON	OFF	-0.5 – +0.5V DC
ON	ON	ON	ON	Configurable via R7CFG

• MECHATROLINK mode: SW2-1, 2-2

SW2-1	SW2-2	MECHATROLINK MODE
OFF	OFF	MECHATROLINK-II (17 byte mode) (*)
ON	OFF	MECHATROLINK-II (32 byte mode)
OFF	ON	MECHATROLINK-I (17 byte mode)

Note: Be sure to set unused SW1-1 through 1-3, SW2-3 and 2-4 to OFF.

POWER SUPPLY TERMINAL ASSIGNMENT

4	5	6	7
NC	NC	+24V	0V
1	2	3	
NC	NC	FE	

1. NC	-
2. NC	-
3. FE	Functional earth
4. NC	-
5. NC	-
6. +24V	Power supply (24V DC)
7. 0V	Power supply (0V)

OUTPUT TERMINAL ASSIGNMENT

10	11	12	13	14	15	16	17	18
NC	VH0	NC	VH1	NC	VH2	NC	VH3	NC
1	2	3	4	5	6	7	8	9
NC	COM0	VL0	COM1	VL1	COM2	VL2	COM3	VL3

NO.	ID	FUNCTION	NO.	ID	FUNCTION
1	NC	No connection	10	NC	No connection
2	COM0	Common 0	11	VH0	Wide span volt. 0
3	VL0	Narrow span volt. 0	12	NC	No connection
4	COM1	Common 1	13	VH1	Wide span volt. 1
5	VL1	Narrow span volt. 1	14	NC	No connection
6	COM2	Common 2	15	VH2	Wide span volt. 2
7	VL2	Narrow span volt. 2	16	NC	No connection
8	COM3	Common 3	17	VH3	Wide span volt. 3
9	VL3	Narrow span volt. 3	18	NC	No connection

OUTPUT RANGE

- **Wide span:** -10 – +10V DC, -5 – +5V DC, 0 – 10V DC, 0 – 5V DC, 1 – 5V DC
- **Narrow span:** -1 – +1V DC, 0 – 1V, -0.5 – +0.5V DC

PC CONFIGURATOR

The following parameter items can be set with using PC Configurator Software (model: R7CFG).

Refer to the users manual for the R7CFG for detailed operation of the software program.

CHANNEL INDIVIDUAL SETTING

PARAMETER	SETTING RANGE	DEFAULT SETTING
Validating/ Invalidating	Valid Invalid	Valid
Output range	-10 to +10V DC -5 to +5V DC -1 to +1V DC 0 to 10V DC 0 to 5V DC 1 to 5V DC 0 to 1V DC -0.5 to +0.5V DC	-10 to +10V DC
Bias	-320.00 to +320.00 (%)	0.00 (%)
Gain	-3.2000 to +3.2000	1.0000
Zero Scale	-32 000 to +32 000	0
Full Scale	-32 000 to +32 000	10000
Output reset value*1	-15.00 to +115.00 (%)	-15.00 (%)

CHANNEL BATCH SETTING

PARAMETER	SETTING RANGE	DEFAULT SETTING
Setting output at the loss of commu- nication*2	Hold Clear	Hold

*1. When output range is -10 to +10V DC, approx. -11.5V DC at approx. -7.5 to -15% and approx. +11.5V DC at approx. 107.5 to 115% are outputted respectively.

*2. Use the DIP switch to change the setting.

MOUNTING INSTRUCTIONS

■ DIN RAIL MOUNTING (PARALLEL)

• Mounting

- 1) Set the upper hook at the rear side of the unit on the DIN rail.
- 2) Push in the lower.

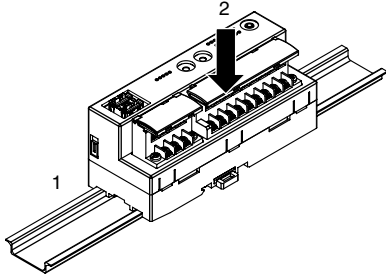

• Dismounting

- 1) Push down the DIN rail mounter slider with tip of a minus screwdriver.
- 2) Pull the lower of the unit.
- 3) Remove the upper hook of the unit from the DIN rail.

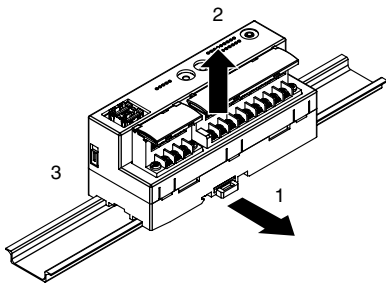

■ DIN RAIL MOUNTING (RIGHT ANGLE)

• Mounting

- 1) Insert the longer DIN rail mounter slider until it clicks twice, as shown below.

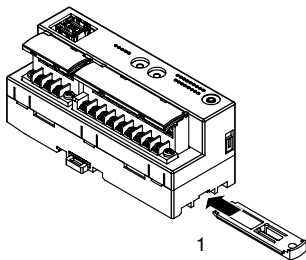

- 2) Set the upper hook at the rear side of the unit on the DIN rail.
- 3) Push in the lower.

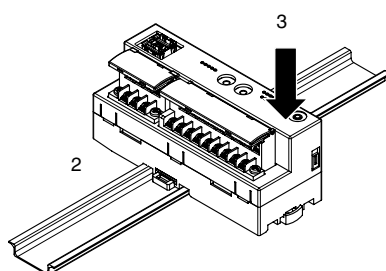

• Dismounting

- 1) Push down the DIN rail mounter slider with tip of a minus screwdriver.
- 2) Pull the lower of the unit.
- 3) Remove the upper hook of the unit from the DIN rail.

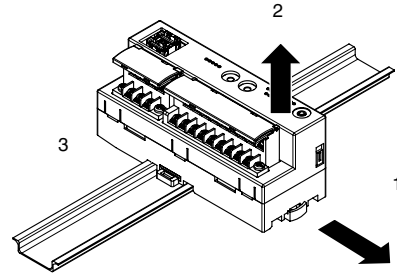

■ SURFACE MOUNTING

- 1) Insert the two DIN rail mounter sliders until it clicks once, as shown below.

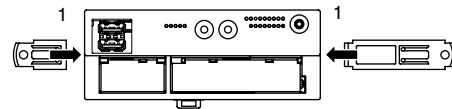

- 2) Mount the unit with M4 screws referring the External Dimensions. (Torque: 1.4 N·m)

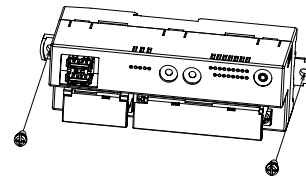

TERMINAL CONNECTIONS

Connect the unit as in the diagram below.

EXTERNAL DIMENSIONS unit: mm (inch)

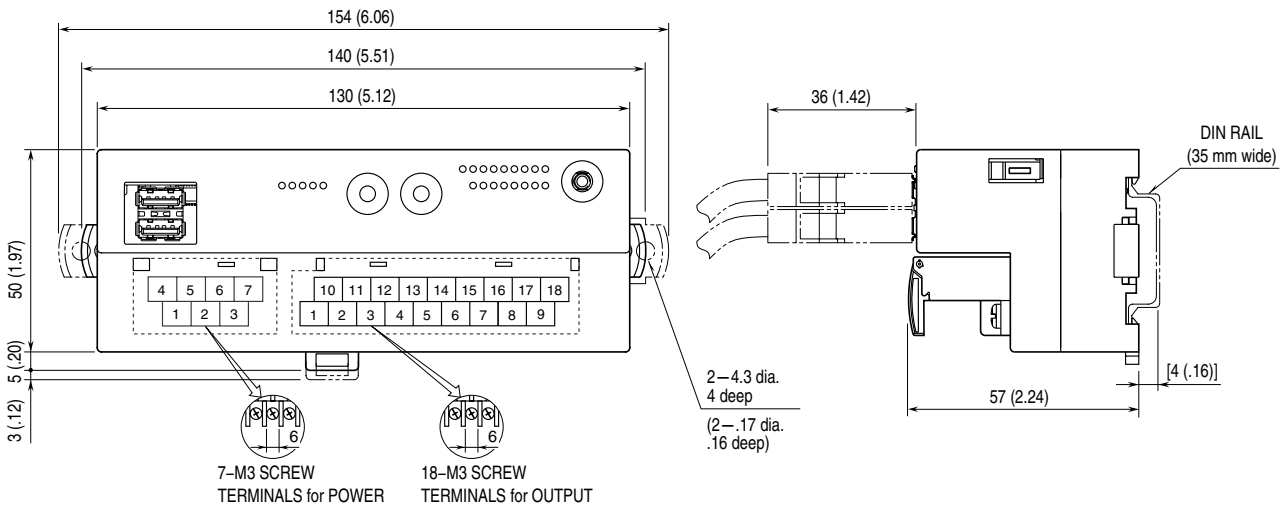

CONNECTION DIAGRAM

Note: In order to improve EMC performance, bond the FE terminal to ground.
 Caution: FE terminal is NOT a protective conductor terminal.

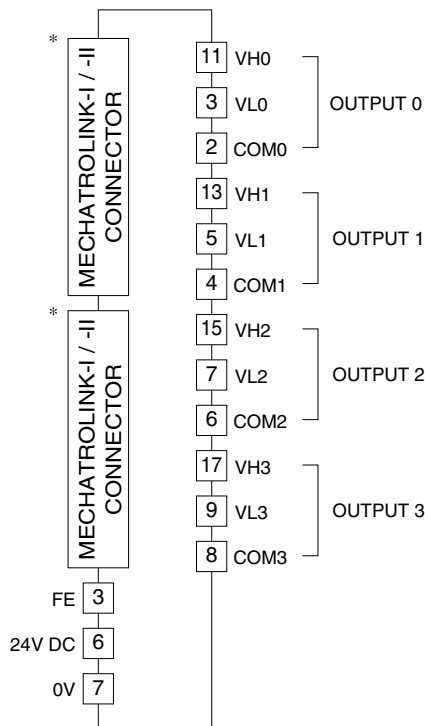

*MECHATROLINK connectors are internally connected.
 The network cable can be connected to either one.

MOUNTING REQUIREMENTS unit: mm (inch)

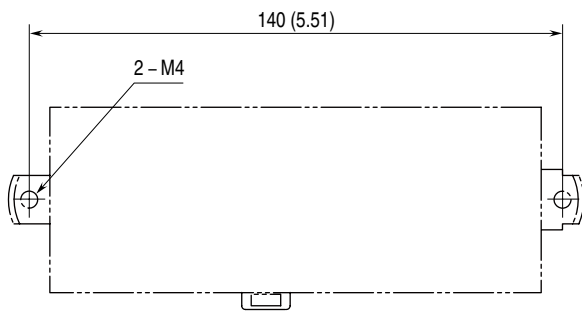

WIRING INSTRUCTIONS

■ TORQUE

Wiring screw for separable terminal: 0.5 N·m
Fixing screw for separable terminal: 0.5 N·m

■ SOLDERLESS TERMINAL

Refer to the drawing below for recommended ring tongue terminal size. Spade tongue type is also applicable.
Applicable wire size: 0.25 to 1.65 mm² (AWG 22 to 16)
Recommended manufacturer: Japan Solderless Terminal MFG. Co., Ltd, Nichifu Co., Ltd

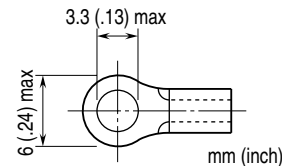

■ HOW TO UNMOUNT THE SEPARABLE TERMINAL

The separable terminal of the unit is 2 piece constructions. It is possible to remove the terminal by loosening two screws of terminal alternately.

COMMUNICATION CABLE CONNECTIONS

■ MECHATROLINK CONNECTION

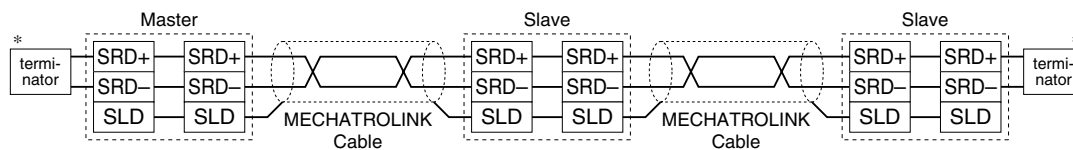

*Terminator

Be sure to connect the terminating resistors to the unit at both ends of transmission line.

Use the terminating resistor dedicated for MECHATROLINK: Model JEPMC-W6022, Yaskawa Controls Co., Ltd.

Certain types of Master units may have incorporated terminating resistors. Consult the instruction manual for the Master.

MECHATROLINK COMMUNICATION

■ MECHATROLINK-I

Baud rate: 4 Mbps

Transmission distance: 50 m max.

Distance between stations: 30 cm min.

Transmission media: MECHATROLINK cable (Model JEPMC-W6003-x-E, Yaskawa Controls Co., Ltd.)

Max. number of slaves: 15 (The maximum number of slaves might change depending on the master unit. Refer to the manual of the master unit)

Transmission cycle: 2 msec. (fixed)

Data length: 17 byte

■ MECHATROLINK-II

Baud rate: 10 Mbps

Transmission distance: 50 m max.

Distance between stations: 50 cm min.

Transmission media: MECHATROLINK cable (Model JEPMC-W6003-x-E, Yaskawa Controls Co., Ltd.)

Max. number of slaves: 30 (The maximum number of slaves might change depending on the master unit. Refer to the manual of the master unit)

Transmission cycle: 0.5 msec., 1 msec., 1.5 msec., 2 msec., 4 msec., 8 msec.

Data length: 17 bytes / 32 bytes selectable (Must choose identical data size for all stations on the same network)

MECHATROLINK RELATED COMMANDS

■ MECHATROLINK DATA LINK LAYER COMMAND DESCRIPTIONS

The R7G4HML (Intelligent I/O) performs the connection-type communications according to MECHATROLINK protocol. The following tables explain Data Link Layer Commands supported by the R7G4HML.

• MDS Command (04H) Data Format

Byte	COMMAND	RESPONSE	REMARKS
0	MDS (04H)	S (0) (90H)	Message Data Search (MDS) Command: Read the ID from the slave station S (0): Response to MDS
1	0	ID1 (00H)	
2	0	ID2 (80H)	Intelligent I/O specified
3	0	0	
4	0	0	
5	0	0	
6	0	0	
7	0	0	
8	0	0	
9	0	0	
10	0	0	
11	0	0	
12	0	0	
13	0	0	
14	0	0	
15	0	0	
16	0	0	
17	0	0	Byte 17 through 31 are always 0 in the 32-byte mode.
:	:	:	These bytes are unavailable for MECHATROLINK-I, or MECHATROLINK-II in the
31	0	0	17-byte mode.

• CDRW Command (03H) Data Format

Byte	COMMAND	RESPONSE	REMARKS
0	CDRW (03H)	ACK (01H)	Cyclic Data Read/Write (CDRW) Command: Link transmission Acknowledge (ACK): Positive response to CDRW
1	CMD	RCMD	CMD: Application Layer Command RCMD: Response to Application Layer Command
2			Byte 2 through 16 depend upon the Application Layer Command type.
:			
16			
17			Byte 17 through 31 depend upon the Application Layer Command type.
:			These bytes are unavailable for MECHATROLINK-I, or MECHATROLINK-II in the
31			17-byte mode.

MECHATROLINK APPLICATION LAYER COMMAND DESCRIPTIONS

The following tables explain Application Layer Commands supported by the R7G4HML (Intelligent I/O).

• NOP Command (00H) Data Format

Byte	COMMAND	RESPONSE	REMARKS
0	CDRW (03H)	ACK (01H)	Cyclic Data Read/Write (CDRW) Command: Link transmission Acknowledge (ACK): Positive response to CDRW
1	NOP (00H)	NOP (00H)	No Operation (NOP) Command: Nothing is performed.
2	0	ALARM	Error code: See "MECHATROLINK DATA DESCRIPTIONS"
3	0	STATUS1	Status code: See "MECHATROLINK DATA DESCRIPTIONS"
4	0	STATUS2	Status code: See "MECHATROLINK DATA DESCRIPTIONS"
5	0	0	
6	0	0	
7	0	0	
8	0	0	
9	0	0	
10	0	0	
11	0	0	
12	0	0	
13	0	0	
14	0	0	
15	0	0	
16	0	0	
17	0	0	Byte 17 through 31 are always 0 in the 32-byte mode.
:	:	:	These bytes are unavailable for MECHATROLINK-I, or MECHATROLINK-II in the 17-byte mode.
31	0	0	

• ID_RD Command (03H) Data Format

Byte	COMMAND	RESPONSE	REMARKS
0	CDRW (03H)	ACK (01H)	Cyclic Data Read/Write (CDRW) Command: Link transmission Acknowledge (ACK): Positive response to CDRW
1	ID_RD (03H)	ID_RD (03H)	Read ID (ID_RD) Command: Read out the device ID
2	0	ALARM	Error code: See "MECHATROLINK DATA DESCRIPTIONS"
3	0	STATUS1	Status code: See "MECHATROLINK DATA DESCRIPTIONS"
4	0	STATUS2	Status code: See "MECHATROLINK DATA DESCRIPTIONS"
5	DEVICE_ CODE	DEVICE_ CODE	Specifies the device code 00H: Product's model number 0FH: Vendor code
6	OFFSET	OFFSET	Indicates where to start reading in the specified device ID
7	SIZE	SIZE	Number of byte counts to read
8	0	ID1	ASCII or binary data
9	0	ID2	ASCII or binary data
10	0	ID3	ASCII or binary data
11	0	ID4	ASCII or binary data
12	0	ID5	ASCII or binary data
13	0	ID6	ASCII or binary data
14	0	ID7	ASCII or binary data
15	0	ID8	ASCII or binary data
16	0	0	
17	0	0	Byte 17 through 31 are always 0 in the 32-byte mode.
:	:	:	These bytes are unavailable for MECHATROLINK-I, or MECHATROLINK-II in the 17-byte mode.
31	0	0	

• CONNECT Command (0EH) Data Format

Byte	COMMAND	RESPONSE	REMARKS
0	CDRW (03H)	ACK (01H)	Cyclic Data Read/Write (CDRW) Command: Link transmission Acknowledge (ACK): Positive response to CDRW
1	CONNECT (0EH)	CONNECT (0EH)	Establish Connection (CONNECT) Command: Requests to establish connection to MECHATROLINK
2	0	ALARM	Error code: See "MECHATROLINK DATA DESCRIPTIONS"
3	0	STATUS1	Status code: See "MECHATROLINK DATA DESCRIPTIONS"
4	0	STATUS2	Status code: See "MECHATROLINK DATA DESCRIPTIONS"
5	VER	VER	Application Layer version number 10H: MECHATROLINK-I 21H: MECHATROLINK-II
6	COM_MODE	COM_MODE	Communication mode 00H: 17-byte mode 80H: 32-byte mode
7	COM_TIME	COM_TIME	Communication cycle (milliseconds) MECHATROLINK-I: Multiples of two (2) MECHATROLINK-II: Integral multiples of the transmission cycle
8	0	0	
9	0	0	
10	0	0	
11	0	0	
12	0	0	
13	0	0	
14	0	0	
15	0	0	
16	0	0	
17	0	0	Byte 17 through 31 are always 0 in the 32-byte mode.
:	:	:	These bytes are unavailable for MECHATROLINK-I, or MECHATROLINK-II in the
31	0	0	17-byte mode.

• DISCONNECT Command (0FH) Data Format

Byte	COMMAND	RESPONSE	REMARKS
0	CDRW (03H)	ACK (01H)	Cyclic Data Read/Write (CDRW) Command: Link transmission Acknowledge (ACK): Positive response to CDRW
1	DISCONNECT (0FH)	DISCONNECT (0FH)	Release Connection (DISCONNECT) Command: Requests to release connection to MECHATROLINK
2	0	ALARM	Error code: See "MECHATROLINK DATA DESCRIPTIONS"
3	0	STATUS1	Status code: See "MECHATROLINK DATA DESCRIPTIONS"
4	0	STATUS2	Status code: See "MECHATROLINK DATA DESCRIPTIONS"
5	0	0	
6	0	0	
7	0	0	
8	0	0	
9	0	0	
10	0	0	
11	0	0	
12	0	0	
13	0	0	
14	0	0	
15	0	0	
16	0	0	
17	0	0	Byte 17 through 31 are always 0 in the 32-byte mode.
:	:	:	These bytes are unavailable for MECHATROLINK-I, or MECHATROLINK-II in the
31	0	0	17-byte mode.

• DATA_RWA Command (50H) Data Format

Byte	COMMAND	RESPONSE	REMARKS
0	CDRW (03H)	ACK (01H)	Cyclic Data Read/Write (CDRW) Command: Link transmission Acknowledge (ACK): Positive response to CDRW
1	DATA_RWA (50H)	DATA_RWA (50H)	Data Read/Write_A (DATA_RWA) Command: Refreshes I/O data
2	0	ALARM	Error code: See "MECHATROLINK DATA DESCRIPTIONS"
3	0	STATUS1	Status code: See "MECHATROLINK DATA DESCRIPTIONS"
4	0	STATUS2	Status code: See "MECHATROLINK DATA DESCRIPTIONS"
5	CH0 OUT LO	CH0 OUT LO (READ BACK)	CH0 Data Lower 8 bits
6	CH0 OUT HI	CH0 OUT HI (READ BACK)	CH0 data Upper 8 bits
7	CH1 OUT LO	CH1 OUT LO (READ BACK)	CH1 data Lower 8 bits
8	CH1 OUT HI	CH1 OUT HI (READ BACK)	CH1 data Upper 8 bits
9	CH2 OUT LO	CH2 OUT LO (READ BACK)	CH2 data Lower 8 bits
10	CH2 OUT HI	CH2 OUT HI (READ BACK)	CH2 data Upper 8 bits
11	CH3 OUT LO	CH3 OUT LO (READ BACK)	CH3 data Lower 8 bits
12	CH3 OUT HI	CH3 OUT HI (READ BACK)	CH3 data Upper 8 bits
13	0	0	Unused
14	0	0	
15	0	STATUS LO	
16	0	STATUS HI	
17	0	0	Byte 17 through 31 are always 0 in the 32-byte mode. These bytes are unavailable for MECHATROLINK-I, or MECHATROLINK-II in the 17-byte mode.
:	:	:	
31	0	0	

■ MECHATROLINK APPLICATION LAYER DATA DESCRIPTIONS

• Alarm Error Codes

Errors detected at the slave are set at ALARM in the response and sent to the master.

ERROR CODE	DESCRIPTION	ALARM LEVEL
00H	Normal status	----
01H	Invalid Command: Command is not supported.	Warning
02H	Command Not Allowed: Command execution conditions are not met.	Warning
03H	Invalid Data: Data in the command is not correct.	Warning
04H	Synchronization Error	Alarm

• STATUS1

Alarm/Warning classification and status information are set at STATUS1 according to the alarm level and sent to the master.

Bit	DEFINITION	DESCRIPTION
0	Alarm Bit	0 : Normal, 1 : Alarm
1	Warning Bit	0 : Normal, 1 : Warning
2	Command Ready Bit	0 : Command cannot be accepted (busy), 1 : Command can be accepted (ready)
3..7	Unused	----

• STATUS2

Reserved for future use.

I/O DATA DESCRIPTION

■ ANALOG OUTPUT

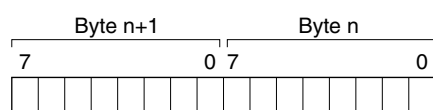

Data is represented in 16-bit binary. Negative value is represented in 2's complements.