

BEFORE USE

Thank you for choosing us. Before use, please check contents of the package you received as outlined below.

If you have any problems or questions with the product, please contact our sales office or representatives.

■ PACKAGE INCLUDES:

Totalized pulse input module(1)

■ MODEL NO.

Confirm Model No. marking on the product to be exactly what you ordered.

■ INSTRUCTION MANUAL

This manual describes necessary points of caution when you use this product, including installation, connection and basic maintenance procedures.

POINTS OF CAUTION**■ CONFORMITY WITH EU DIRECTIVE**

- Use dual-shield cables (Shinko Seisen Industry Model ZHY262 PBA) for the network. If it is not sufficient, use a ferrite core (Kitagawa Industries Model GRFC-13) for the network cable.
- The equipment must be mounted inside the instrument panel of a metal enclosure.
- The actual installation environments such as panel configurations, connected devices, connected wires, may affect the protection level of this unit when it is integrated in a panel system. The user may have to review the CE requirements in regard to the whole system and employ additional protective measures to ensure the CE conformity.

■ POWER INPUT RATING & OPERATIONAL RANGE

- Locate the power input rating marked on the product and confirm its operational range as indicated below:
24V DC rating: 24V \pm 10%, approx. 50mA

■ GENERAL PRECAUTIONS

- Before you remove the unit or mount it, turn off the power supply and input signal for safety.
- DO NOT set the switches on the module while the power is supplied. The switches are used only for maintenance without the power.

■ ENVIRONMENT

- Indoor use.
- When heavy dust or metal particles are present in the air, install the unit inside proper housing with sufficient ventilation.
- Do not install the unit where it is subjected to continuous vibration. Do not subject the unit to physical impact.
- Environmental temperature must be within -10 to +55°C (14 to 131°F) with relative humidity within 30 to 90% RH in order to ensure adequate life span and operation.

■ WIRING

- Do not install cables close to noise sources (relay drive cable, high frequency line, etc.).
- Do not bind these cables together with those in which noises are present. Do not install them in the same duct.

■ AND

- The unit is designed to function as soon as power is supplied, however, a warm up for 10 minutes is required for satisfying complete performance described in the data sheet.

COMPONENT IDENTIFICATION

■ SIDE VIEW

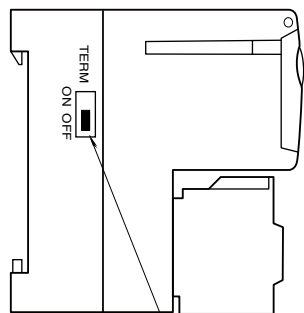

Terminating Resistor SW

■ FRONT VIEW

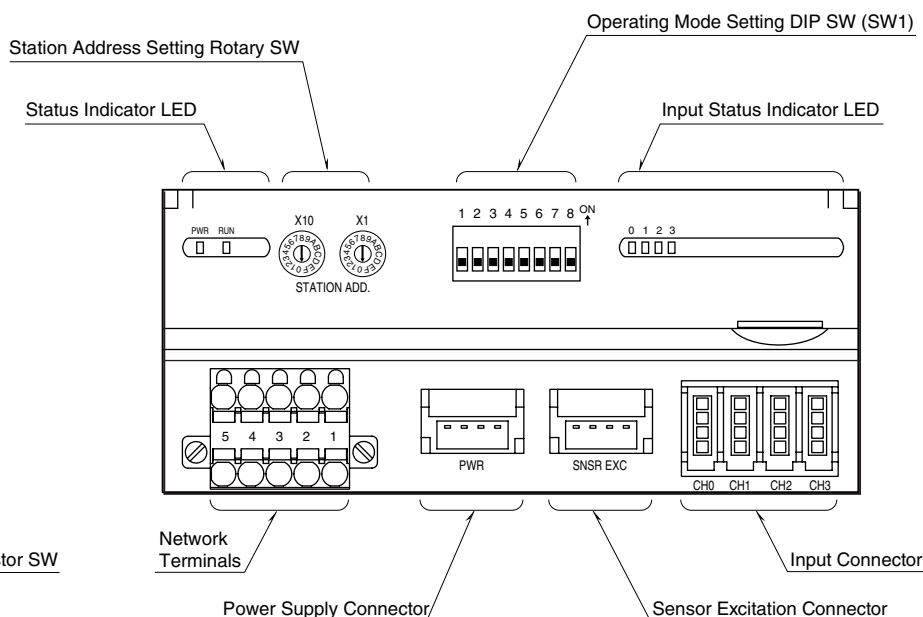

■ STATUS INDICATOR LED

ID	COLOR	FUNCTION
PWR	Green	Turns on when the internal 5V is supplied normally.
RUN	Green	Turns on when the refresh data is received normally.

■ INPUT STATUS INDICATOR LED

LED indicators shows signal status.

ON (Lo between GND and IN0 thr. IN3): LED ON (red)
 OFF: LED OFF

■ STATION ADDRESS

The left switch determines the sixteenths place digit, while the right switch does the ones place digit of the address. Data allocation is 4.

• Full-duplex communication

When the switch setting is n, the addresses will be n, n+2, n+4 and n+6. (Range: 01H to 39H)

• Half-duplex communication

The addresses will be continuous four from the switch setting. (Range: 01H to 3CH)

Address Allocation	CH0	CH1	CH2	CH3
Full-duplex	n	n+2	n+4	n+6
Half-duplex	n	n+1	n+2	n+3



Station Address Setting (x1)

Station Address Setting (x16)

■ OPERATION MODE

• Transfer rate (SW1-8)

SW1-8	TRANSFER RATE
OFF	12 Mbps (*)
ON	6 Mbps

(*) Factory setting

Note: Be sure to set unused SW1-1 through 1-7 to OFF.

■ TERMINATING RESISTOR

To use the terminating resistor, turn the switch ON, and OFF to invalidate. (Factory setting OFF)

■ POWER SUPPLY, SENSOR EXCITATION

Recommended cable connector: 38104-00x-000FL*² (3M)
 (not included in the package)

No.	ID (Power Supply)	ID (Sensor Excitation)
4	0V	GND
3	0V	GND
2	24 V DC	+24 V
1	24 V DC	+24 V

■ NETWORK

Recommended cable connector: TFKC2,5/5-STF-5,08AU
 (Phoenix Contact) (included in the package)

Applicable wire size: 0.2 – 2.5 mm²; stripped length 10 mm

Recommended solderless terminal

For ZHY262PS, ZHT262PS and ZHY262PBA: TUB-0.5
 (Japan Solderless Terminal MFG. Co., Ltd.)

For ZHY221PS: AI0,5-10WH (Phoenix Contact)

No.	ID (Full-duplex)	ID (Half-duplex)
5	RXD-	NC
4	RXD+	NC
3	TXD-	TRD-
2	TXD+	TRD+
1	SHIELD	SHIELD

■ INPUT

Recommended cable connector: 37104-x-000FL*2 (3M)
(not included in the package)

No.	ID	FUNCTION
4	IN0 through IN3	Input 0 through 3
3	GND	GND
2	NC	No connection
1	+24V	Sensor excitation

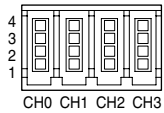

*2 'x' shows wire size. Refer to the manufacturer's catalogue.

TERMINAL CONNECTIONS

Connect the unit as in the diagram below.

■ EXTERNAL DIMENSIONS unit: mm (inch)

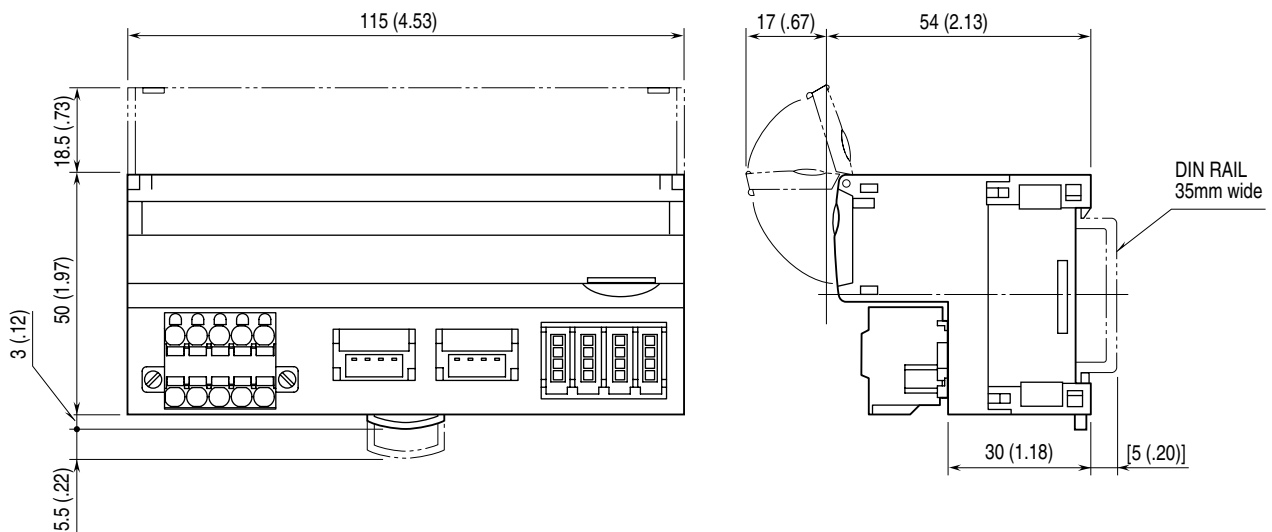

■ CONNECTION DIAGRAM

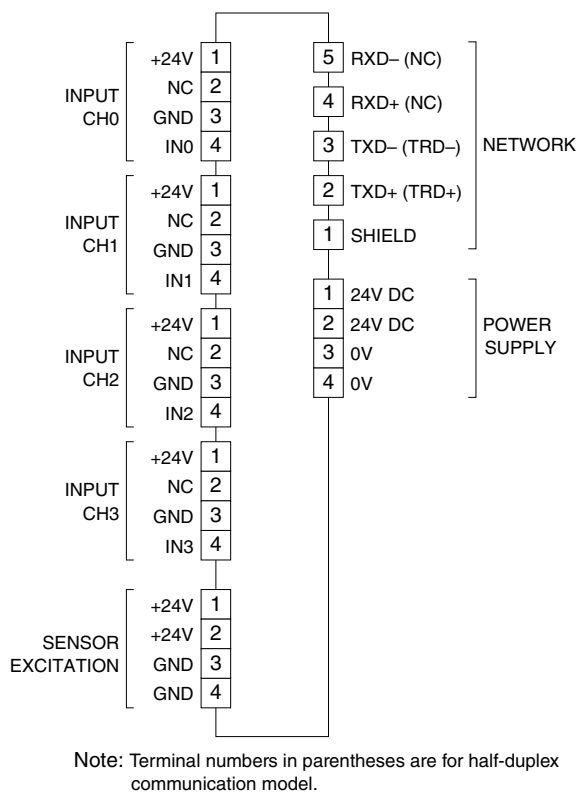

■ Input Connection Examples

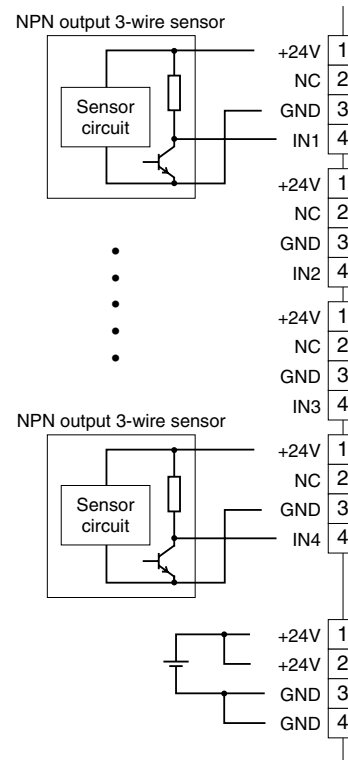

■ 2-Wire Sensor

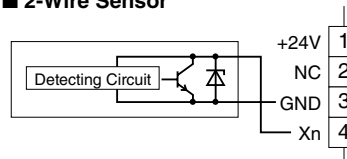

COMMUNICATION CABLE CONNECTIONS

■ MASTER CONNECTION

• Full-duplex communication

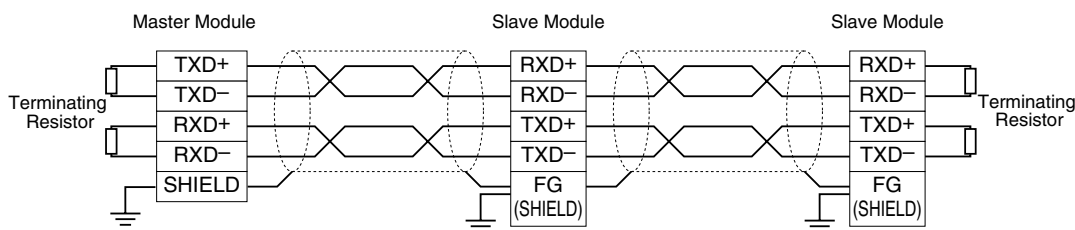

• Half-duplex communication

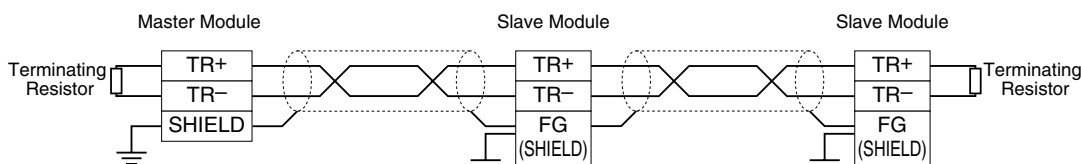

Note: Be sure to turn ON the switch of the terminating resistor located at both ends of the modules.

I/O DATA DESCRIPTIONS

• Di area

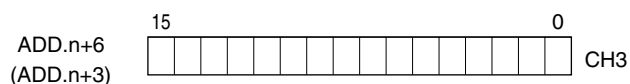
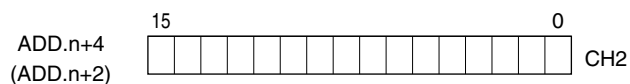
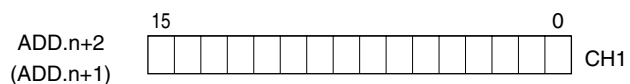
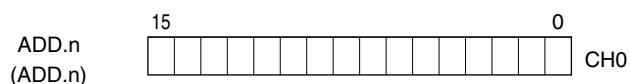

• Do area

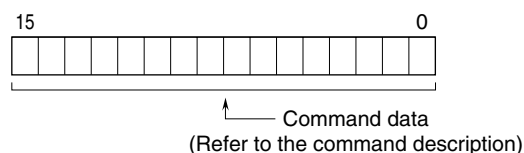
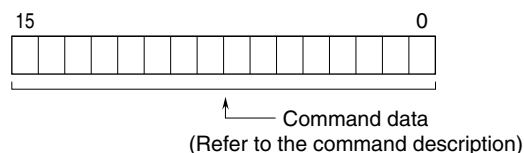
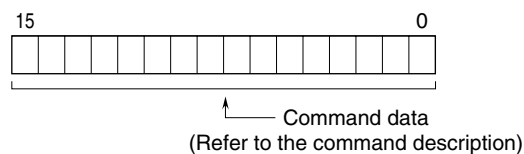
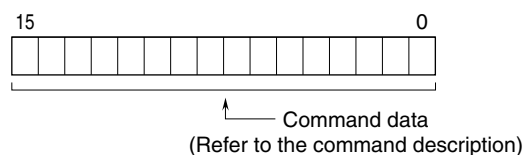

The data is 16-bit binary.
Addresses in parentheses are for half-duplex mode.

COMMAND DESCRIPTION

• Do area

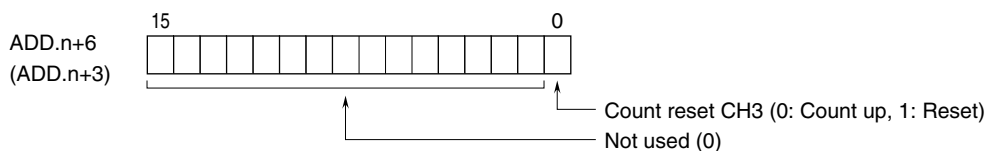
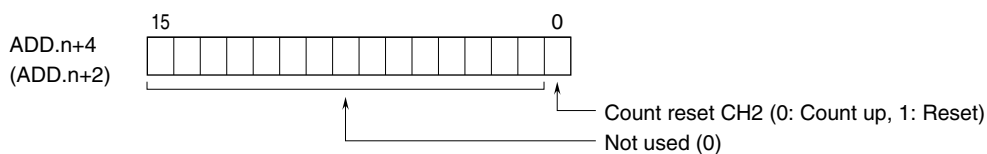
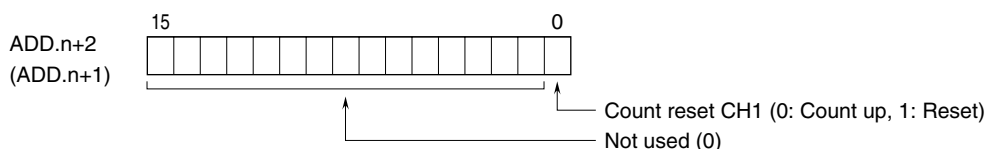
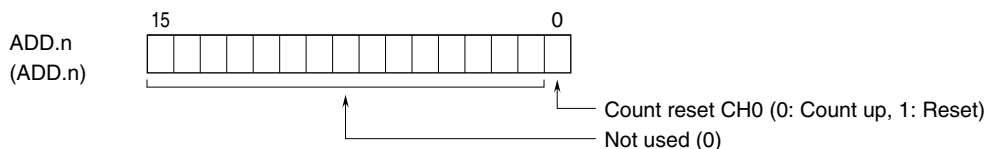

Addresses in parentheses are for half-duplex mode.