

MECHATROLINK I/O MODULE

(NPN transistor output & NPN/PNP discrete input, 16 points each,
screw terminal block, MECHATROLINK-I/-II use)

MODEL R7K4FML-6-DCA32A**BEFORE USE**

Thank you for choosing us. Before use, please check contents of the package you received as outlined below. If you have any problems or questions with the product, please contact our sales office or representatives.

■ PACKAGE INCLUDES:

Discrete I/O module(1)
Mounter slider(2)

■ MODEL NO.

Confirm Model No. marking on the product to be exactly what you ordered.

■ INSTRUCTION MANUAL

This manual describes necessary points of caution when you use this product, including installation, connection and basic maintenance procedures.

POINTS OF CAUTION**■ CONFORMITY WITH EU DIRECTIVES**

- The equipment must be mounted inside the instrument panel of a metal enclosure.
- The actual installation environments such as panel configurations, connected devices, connected wires, may affect the protection level of this unit when it is integrated in a panel system. The user may have to review the CE requirements in regard to the whole system and employ additional protective measures to ensure the CE conformity.

■ POWER INPUT RATING & OPERATIONAL RANGE

- Locate the power input rating marked on the product and confirm its operational range as indicated below:
24V DC rating: 24V \pm 10%, approx. 60mA

■ GENERAL PRECAUTIONS

- Before you remove the unit or mount it, turn off the power supply and I/O signal for safety.
- Before you remove the terminal block or mount it, make sure to turn off the power supply and I/O signal for safety.
- DO NOT set the switches on the module while the power is supplied. The switches are used only for maintenance without the power.

■ ENVIRONMENT

- Indoor use.
- When heavy dust or metal particles are present in the air, install the unit inside proper housing with sufficient ventilation.
- Do not install the unit where it is subjected to continuous vibration. Do not subject the unit to physical impact.
- Environmental temperature must be within 0 to 55°C (32 to 131°F) with relative humidity within 30 to 90% RH in order to ensure adequate life span and operation.

■ WIRING

- Do not install cables close to noise sources (relay drive cable, high frequency line, etc.).
- Do not bind these cables together with those in which noises are present. Do not install them in the same duct.
- Be sure to close the terminal cover for safety.

■ AND

- The unit is designed to function as soon as power is supplied, however, a warm up for 10 minutes is required for satisfying complete performance described in the data sheet.

COMPONENT IDENTIFICATION

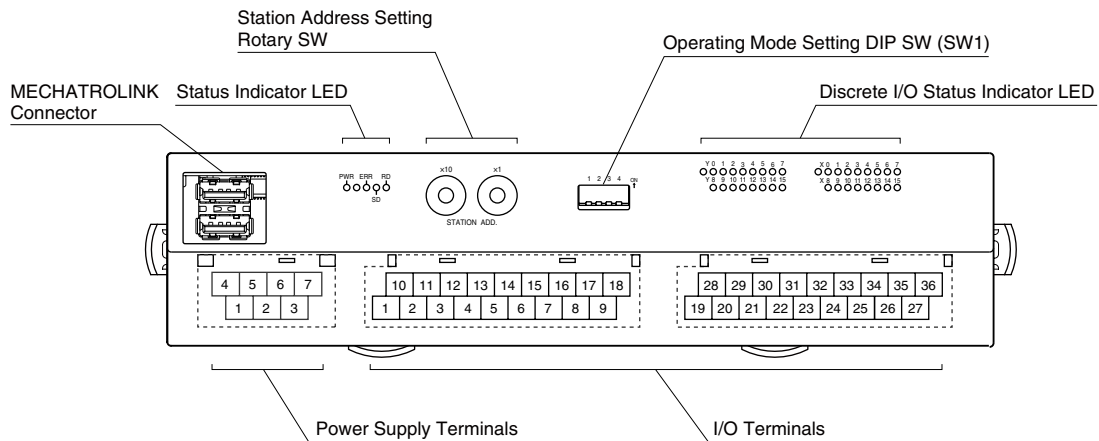

■ STATUS INDICATOR LED

ID	COLOR	FUNCTION
PWR	Green	Turns on when the internal power is supplied normally.
ERR	Red	Turns on in station address setting error.
SD	Green	Turns on in station address transmitting.
RD	Green	Turns on when the module is receiving.

■ DISCRETE I/O STATUS INDICATOR LED

LED green indicators showing I/O signal status.

ON : LED ON
OFF : LED OFF

■ STATION ADDRESS

Station Address is selected between 60H and 7FH (Simple I/O) in hexadecimal.

The left switch and the right switch determine the MSD and the LSD of the address, respectively.

(Factory setting: 61H)

Certain numbers may not be selectable depending on the master types.

Refer to the instruction manual of the master unit for detail.

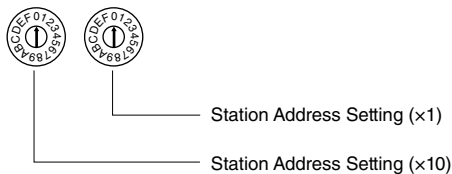

■ OPERATING MODE

• MECHATROLINK mode: SW1-1, 1-2

Choose MECHATROLINK-I or -II, and the data size. SW1-1 and SW1-2 are used.

SW1-1	SW1-2	MECHATROLINK MODE
OFF	OFF	MECHATROLINK-II (32 byte mode) (*)
ON	OFF	MECHATROLINK-II (17 byte mode)
ON	ON	MECHATROLINK-I (17 byte mode)

(*) Factory setting

Note: Be sure to set unused SW1-3 and 1-4 to OFF.

■ POWER SUPPLY TERMINAL ASSIGNMENT

4	5	6	7
NC	NC	+24V	0V
1	2	3	
NC	NC	FE	

1. NC	-
2. NC	-
3. FE	Functional earth
4. NC	-
5. NC	-
6. +24V	Power supply (24V DC)
7. 0V	Power supply (0V)

■ I/O TERMINAL ASSIGNMENT

10	11	12	13	14	15	16	17	18
+24V	Y1	Y3	Y5	Y7	Y9	Y11	Y13	Y15
1	2	3	4	5	6	7	8	9
0V	Y0	Y2	Y4	Y6	Y8	Y10	Y12	Y14

28	29	30	31	32	33	34	35	36
COM	X1	X3	X5	X7	X9	X11	X13	X15
19	20	21	22	23	24	25	26	27
COM	X0	X2	X4	X6	X8	X10	X12	X14

NO.	ID	FUNCTION	NO.	ID	FUNCTION
1	0V	0V(Out. Common)	10	+24V	24V DC
2	Y0	Output 0	11	Y1	Output 1
3	Y2	Output 2	12	Y3	Output 3
4	Y4	Output 4	13	Y5	Output 5
5	Y6	Output 6	14	Y7	Output 7
6	Y8	Output 8	15	Y9	Output 9
7	Y10	Output 10	16	Y11	Output 11
8	Y12	Output 12	17	Y13	Output 13
9	Y14	Output 14	18	Y15	Output 15

NO.	ID	FUNCTION	NO.	ID	FUNCTION
19	COM	Common	28	COM	Common
20	X0	Input 0	29	X1	Input 1
21	X2	Input 2	30	X3	Input 3
22	X4	Input 4	31	X5	Input 5
23	X6	Input 6	32	X7	Input 7
24	X8	Input 8	33	X9	Input 9
25	X10	Input 10	34	X11	Input 11
26	X12	Input 12	35	X13	Input 13
27	X14	Input 14	36	X15	Input 15

MOUNTING INSTRUCTIONS

■ DIN RAIL MOUNTING

• Mounting

- 1) Set the upper hook at the rear side of the unit on the DIN rail.
- 2) Push in the lower.

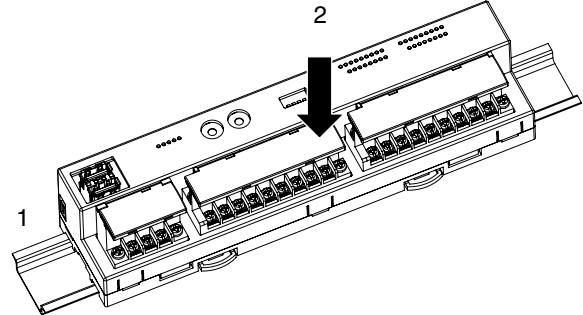

• Dismounting

- 1) Push down the DIN rail mounter slider with tip of a minus screwdriver.
- 2) Pull the lower of the unit.
- 3) Remove the upper hook of the unit from the DIN rail.

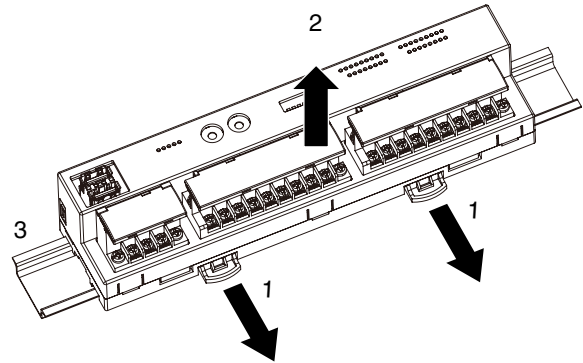

■ SURFACE MOUNTING

- 1) Insert the two DIN rail mounter sliders until it clicks once, as shown below.

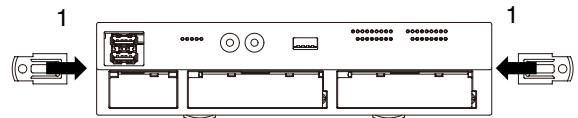

- 2) Mount the unit with M4 screws referring the Mounting Requirements. (Torque: 1.4 N·m)

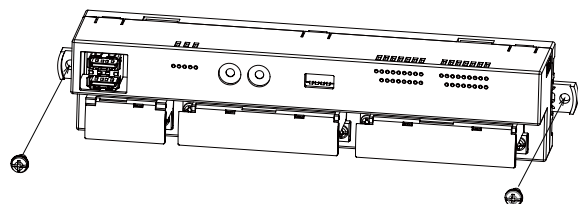

TERMINAL CONNECTIONS

Connect the unit as in the diagram below.

■ EXTERNAL DIMENSIONS unit: mm (inch)

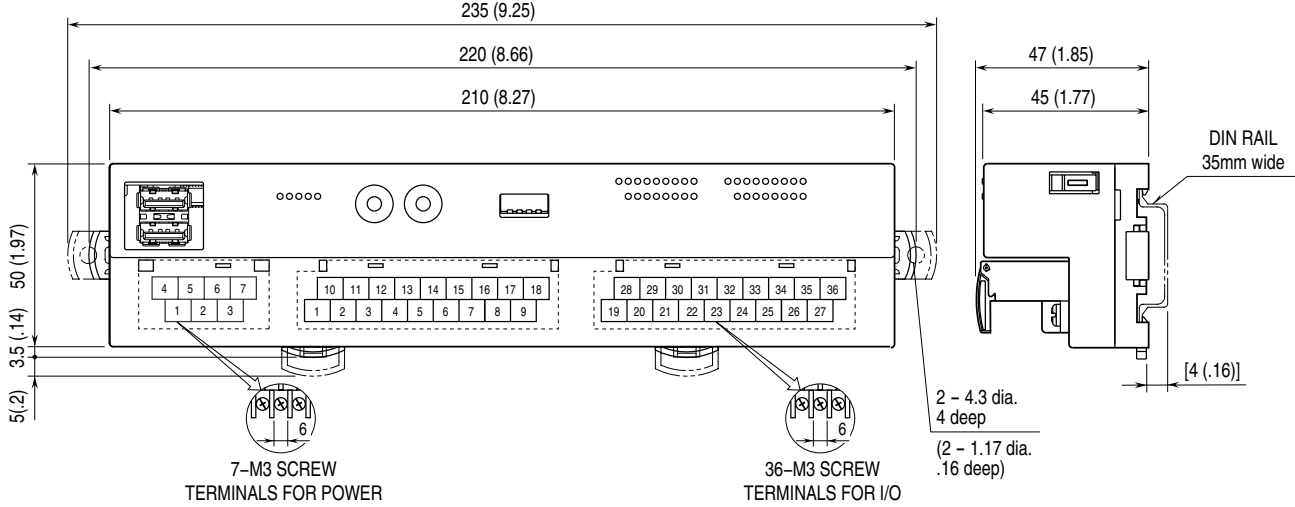

CONNECTION DIAGRAM

Note: In order to improve EMC performance, bond the FE terminal to ground.
 Caution: FE terminal is NOT a protective conductor terminal.

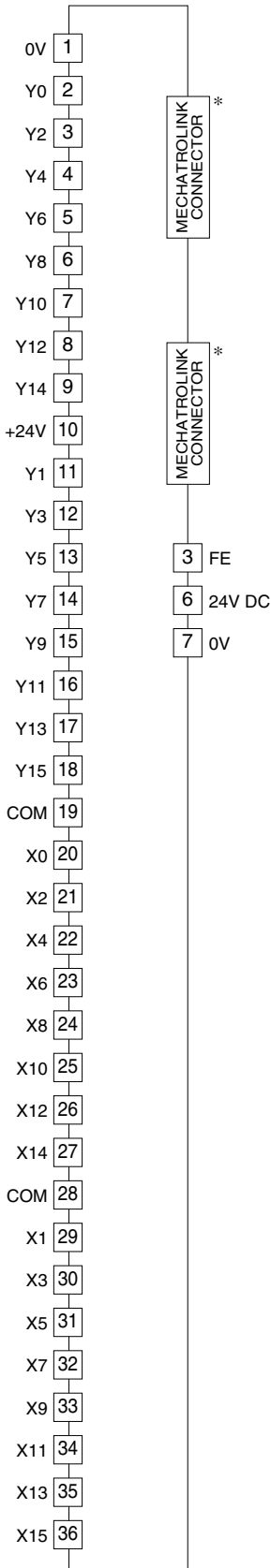

Output Connection Examples

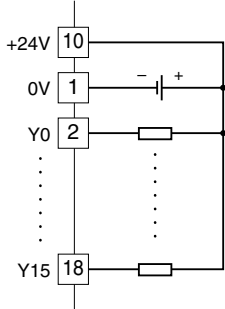

Input Connection Examples

PNP Connection

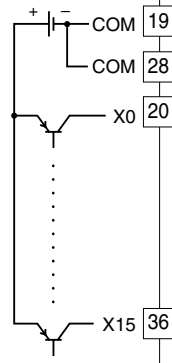

NPN Connection

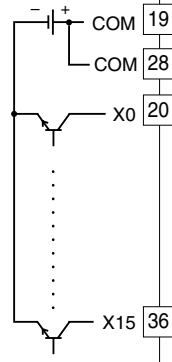

* MECHATROLINK connectors are internally connected. The network cable can be connected to either one.

MOUNTING REQUIREMENTS unit: mm (inch)

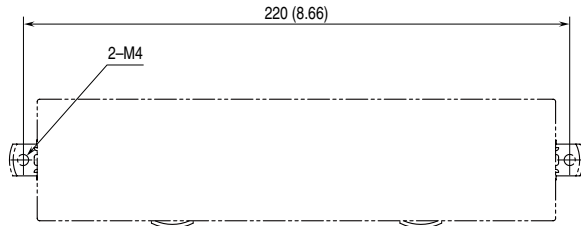

WIRING INSTRUCTIONS

TORQUE

Wiring screw for separable terminal: 0.5 N·m
 Fixing screw for separable terminal: 0.5 N·m

SOLDERLESS TERMINAL

Refer to the drawing below for recommended ring tongue terminal size. Spade tongue type is also applicable.
 Applicable wire size: 0.25 to 1.65 mm² (AWG 22 to 16)
 Recommended manufacturer: Japan Solderless Terminal MFG. Co., Ltd, Nichifu Co., Ltd

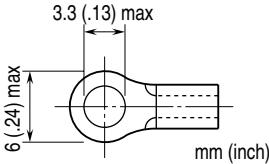

HOW TO UNMOUNT THE SEPARABLE TERMINAL

The separable terminal of the unit is 2 piece constructions. It is possible to remove the terminal by loosening two screws of terminal alternately.

COMMUNICATION CABLE CONNECTIONS

MECHATROLINK CONNECTION

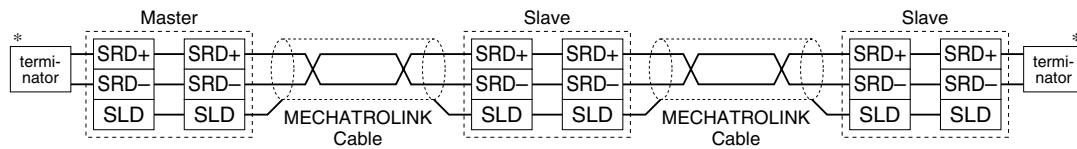

* Terminator

Be sure to connect the terminating resistors to the unit at both ends of transmission line.

Use the terminating resistor dedicated for MECHATROLINK: Model JEPMC-W6022, Yaskawa Controls Co., Ltd.

Certain types of Master units may have incorporated terminating resistors. Consult the instruction manual for the Master.

MECHATROLINK COMMUNICATION

MECHATROLINK-I

Baud rate: 4 Mbps

Transmission distance: 50 m max.

Distance between stations: 30 cm min.

Transmission media: MECHATROLINK cable (Model JEPMC-W6003-x-E, Yaskawa Controls Co., Ltd.)

Max. number of slaves: 15 (The maximum number of slaves might change depending on the master unit. Refer to the manual of the master unit.)

Transmission cycle: 2 msec. (fixed)

Data length: 17 byte

MECHATROLINK-II

Baud rate: 10 Mbps

Transmission distance: 50 m max.

Distance between stations: 50 cm min.

Transmission media: MECHATROLINK cable (Model JEPMC-W6003-x-E, Yaskawa Controls Co., Ltd.)

Max. number of slaves: 30 (The maximum number of slaves might change depending on the master unit. Refer to the manual of the master unit.)

Transmission cycle: 0.25 msec., 0.5 msec., 1 msec., 1.5 msec., 2 msec., 4 msec., 8 msec.

Data length: 17 bytes / 32 bytes selectable (Must choose identical data size for all stations on the same network)

MECHATROLINK RELATED COMMANDS

R7K4FML (Simple I/O) communicates with I/O service with no processor, therefore it uses a connectionless communication protocol. There is no application layer either; the R7K4FML interchanges I/O data via data link layer.

MECHATROLINK DATA LINK LAYER COMMAND DESCRIPTIONS

The following tables explain the two Commands supported by the R7K4FML.

• MDS Command (04H) Data Format

BYTE	COMMAND	RESPONSE	REMARKS
0	MDS (04H)	S(0) (90H)	Message Data Search (MDS) Command: Read the ID from slave station(s) S(0): Response to MDS
1	0	ID	
2	0		
3	0	0	All 0
4	0	0	
5	0	0	
6	0	0	
7	0	0	
8	0	0	
9	0	0	
10	0	0	
11	0	0	
12	0	0	
13	0	0	
14	0	0	
15	0	0	
16	0	0	
17	0	0	Byte 17 through 31 are always 0 in the 32-byte mode. These bytes are unavailable for MECHATROLINK-I and MECHATROLINK-II in the 17-byte mode.
:	:	:	
31	0	0	

• CDRW Command (03H) Data Format

BYTE	COMMAND	RESPONSE	REMARKS
0	CDRW (03H)	ACK (01H)	Cyclic Data Read/Write (CDRW) Command: Link transmission Acknowledge (ACK): Positive response to CDRW
1	Out Data: Lowest	In Data: Lowest	Order of data: Little Endian
2			
3			
4			
5			
6			
7			
8			
9			
10			
11			
12			
13			
14			
15			
16	Out Data: Highest	In Data: Highest	
17	(Out Data: Highest)	(In Data: Highest)	Byte 17 through 31 are unavailable for MECHATROLINK-I and MECHATROLINK-II in the 17-byte mode. (Only available for MECHATROLINK-II in the 32-byte mode)
:			
31			

I/O DATA DESCRIPTIONS

■ 17-BYTE MODE

• 16 points output data (Out Data)

Byte	Bit7	Bit6	Bit5	Bit4	Bit3	Bit2	Bit1	Bit0
1	0	0	0	0	0	0	0	0
2	0	0	0	0	0	0	0	0
3	0	0	0	0	0	0	0	0
4	0	0	0	0	0	0	0	0
5	0	0	0	0	0	0	0	0
⋮	0	0	0	0	0	0	0	0
⋮	0	0	0	0	0	0	0	0
12	0	0	0	0	0	0	0	0
13	0	0	0	0	0	0	0	0
14	0	0	0	0	0	0	0	0
15	Out7	Out6	Out5	Out4	Out3	Out2	Out1	Out0
16	Out15	Out14	Out13	Out12	Out11	Out10	Out9	Out8

• 16 points input data (In Data)

Byte	Bit7	Bit6	Bit5	Bit4	Bit3	Bit2	Bit1	Bit0
1	In7	In6	In5	In4	In3	In2	In1	In0
2	In15	In14	In13	In12	In11	In10	In9	In8
3	0	0	0	0	0	0	0	0
4	0	0	0	0	0	0	0	0
5	0	0	0	0	0	0	0	0
⋮	0	0	0	0	0	0	0	0
⋮	0	0	0	0	0	0	0	0
12	0	0	0	0	0	0	0	0
13	0	0	0	0	0	0	0	0
14	0	0	0	0	0	0	0	0
15	0	0	0	0	0	0	0	0
16	0	0	0	0	0	0	0	0

■ 32-BYTE MODE

• 16 points output data (Out Data)

Byte	Bit7	Bit6	Bit5	Bit4	Bit3	Bit2	Bit1	Bit0
1	0	0	0	0	0	0	0	0
2	0	0	0	0	0	0	0	0
3	0	0	0	0	0	0	0	0
4	0	0	0	0	0	0	0	0
5	0	0	0	0	0	0	0	0
⋮	0	0	0	0	0	0	0	0
⋮	0	0	0	0	0	0	0	0
28	0	0	0	0	0	0	0	0
29	0	0	0	0	0	0	0	0
30	0	0	0	0	0	0	0	0
31	Out7	Out6	Out5	Out4	Out3	Out2	Out1	Out0
32	Out15	Out14	Out13	Out12	Out11	Out10	Out9	Out8

• 16 points input data (In Data)

Byte	Bit7	Bit6	Bit5	Bit4	Bit3	Bit2	Bit1	Bit0
1	In7	In6	In5	In4	In3	In2	In1	In0
2	In15	In14	In13	In12	In11	In10	In9	In8
3	0	0	0	0	0	0	0	0
4	0	0	0	0	0	0	0	0
5	0	0	0	0	0	0	0	0
⋮	0	0	0	0	0	0	0	0
⋮	0	0	0	0	0	0	0	0
28	0	0	0	0	0	0	0	0
29	0	0	0	0	0	0	0	0
30	0	0	0	0	0	0	0	0
31	0	0	0	0	0	0	0	0
32	0	0	0	0	0	0	0	0

0: OFF, 1: ON

At the loss of communication, output is hold (last data correctly received is hold).