

BEFORE USE

Thank you for choosing us. Before use, please check contents of the package you received as outlined below.

If you have any problems or questions with the product, please contact our sales office or representatives.

■ PACKAGE INCLUDES:

Discrete input module.....(1)

■ MODEL NO.

Confirm that the model number described on the product is exactly what you ordered.

■ INSTRUCTION MANUAL

This manual describes necessary points of caution when you use this product, including installation, connection and basic maintenance procedures.

POINTS OF CAUTION**■ CONFORMITY WITH EU DIRECTIVE**

- Use MECHATROLINK-II network cable with core (Yasukawa Controls Model JEPEC-W6003-x-E) or equivalent for the network.
- Be sure to earth FG terminal.
- The actual installation environments such as panel configurations, connected devices and connected wires may affect the protection level of this unit when it is integrated in a panel system. The user may have to review the CE requirements in regard to the whole system and employ additional protective measures to ensure CE conformity.

■ POWER INPUT RATING & OPERATIONAL RANGE

- Locate the power input rating marked on the product and confirm its operational range as indicated below:
24V DC rating: 24V \pm 10%, approx. 70mA

■ GENERAL PRECAUTIONS

- Before you remove the unit or mount it, turn off the power supply and input signal for safety.

■ ENVIRONMENT

- Indoor use
- When heavy dust or metal particles are present in the air, install the unit inside proper housing with sufficient ventilation.
- Do not install the unit where it is subjected to continuous vibration. Do not subject the unit to physical impact.
- Environmental temperature must be within 0 to 55°C (32 to 131°F) with relative humidity within 30 to 90% RH in order to ensure adequate life span and operation.

■ WIRING

- Do not install cables close to noise sources (relay drive cable, high frequency line, etc.).
- Do not bind these cables together with those in which noises are present. Do not install them in the same duct.
- FG terminal is NOT a protective conductor terminal.

■ AND

- The unit is designed to function as soon as power is supplied, however, a warm up for 10 minutes is required for satisfying complete performance described in the data sheet.

COMPONENT IDENTIFICATION

FRONT VIEW

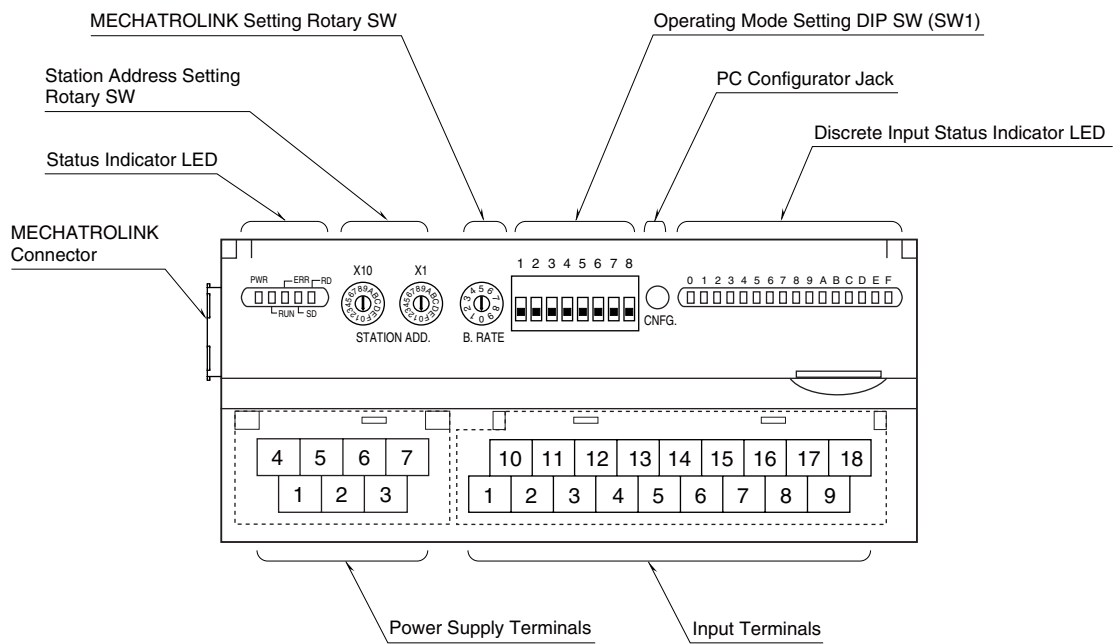

LEFT SIDE VIEW

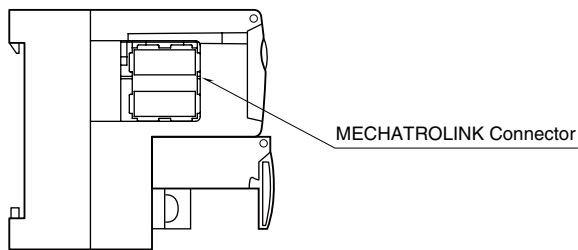

■ STATUS INDICATOR LED

ID	COLOR	FUNCTION
PWR	Green	Turns on when the internal 5V is supplied normally.
RUN	Green	Turns on in normal communications conditions.
ERR	Red	Turns on in no communication or setting error.
SD	Green	Turns on when the module is transmitting.
RD	Green	Turns on when the module is receiving.

■ STATION ADDRESS

Station Address is selected between 60H and 7FH (Intelligent I/O) in hexadecimal. (Certain numbers may not be selectable depending on the master types. Refer to the instruction manual of the master unit.)

The left switch determines the MSD, while the right switch does the LSD of the address.

(Factory setting: 60H)

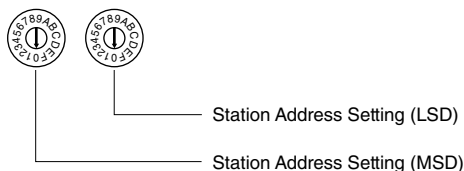

■ MECHATROLINK MODE

Choose MECHATROLINK-I or -II, and the data size. Positions 2, 4 through 9 are unused.

(Factory setting: 1)

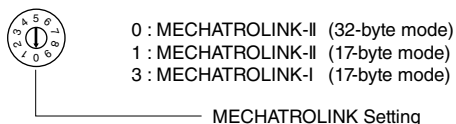

■ EXTENSION MODULE

Combinations with any extension module is selectable.

■ OPERATING MODE

(*) Factory setting

• Extension (SW1-1, 1-2)

SW1-1	SW1-2	Extension
OFF	OFF	No extension (*)
ON	OFF	Discrete input, 8 or 16 points
OFF	ON	Discrete output, 8 or 16 points

• Read rate (SW1-6, 1-7, 1-8)

SW1-6	SW1-7	SW1-8	Extension
OFF	OFF	OFF	≤10 msec. (*)
ON	OFF	OFF	≤1 msec.
OFF	ON	OFF	≤5 msec.
OFF	ON	OFF	≤20 msec.
ON	OFF	ON	≤50 msec.
OFF	OFF	ON	≤70 msec.
ON	ON	ON	≤100 msec.
OFF	ON	ON	≤200 msec.

Caution ! - SW1-3, 1-4, 1-5 are unused. Be sure to turn off unused ones.

■ DISCRETE INPUT STATUS INDICATOR LED

Discrete input modules including those for extensions have LED indicators showing input signal status.

Contact ON : LED ON

Contact OFF: LED OFF

■ POWER SUPPLY TERMINAL ASSIGNMENT

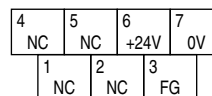

NO.	ID	FUNTION
1	NC	----
2	NC	----
3	FG	FG
4	NC	----
5	NC	----
6	+24V	Power input (24V DC)
7	0V	Power input (0V)

■ INPUT TERMINAL ASSIGNMENT

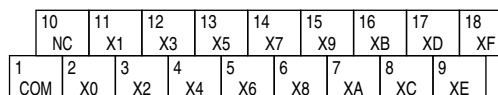

NO.	ID	FUNCTION	NO.	ID	FUNTION
1	COM	Common	10	NC	No Connection
2	X0	Input 0	11	X1	Input 1
3	X2	Input 2	12	X3	Input 3
4	X4	Input 4	13	X5	Input 5
5	X6	Input 6	14	X7	Input 7
6	X8	Input 8	15	X9	Input 9
7	XA	Input 10	16	XB	Input 11
8	XC	Input 12	17	XD	Input 13
9	XE	Input 14	18	XF	Input 15

EXTERNAL DIMENSIONS UNIT: MM (INCH)

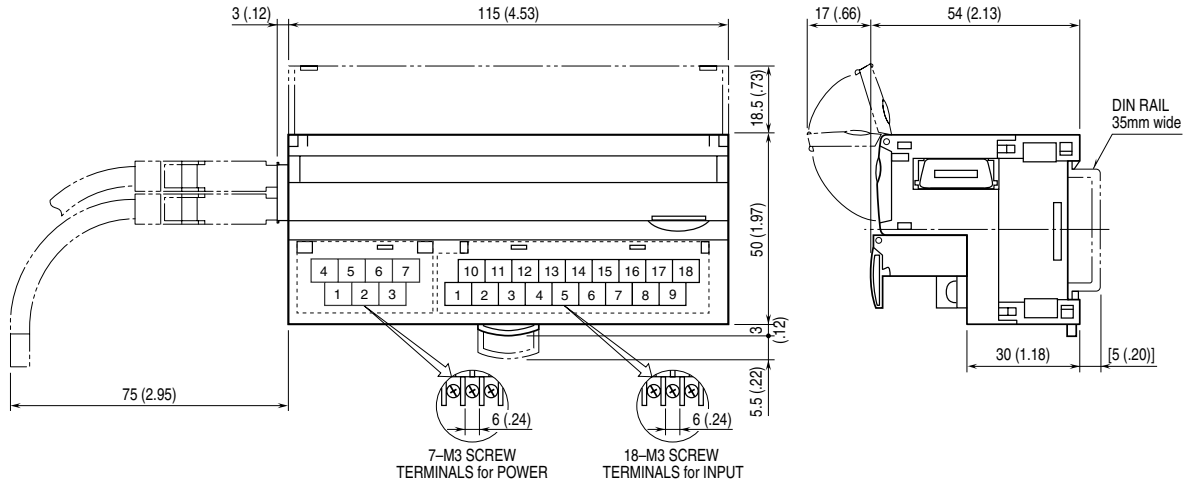

CONNECTION DIAGRAM

Connect the unit as in the diagram below.

Note: In order to improve EMC performance, bond the FE terminal to ground.

Caution: FE terminal is NOT a protective conductor terminal.

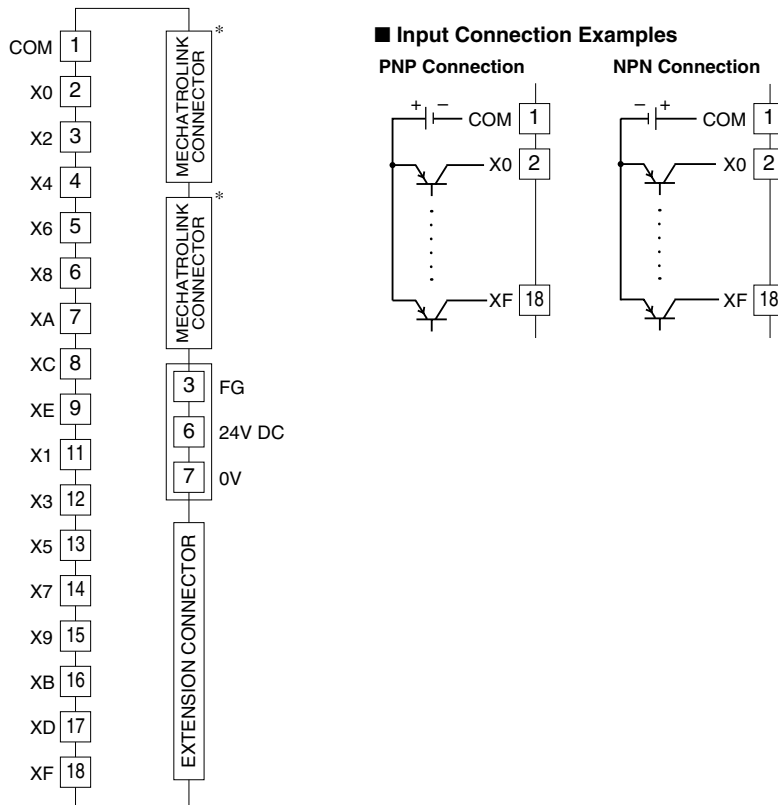

*MECHATROLINK connectors are internally connected.
The network cable can be connected to either one.

WIRING INSTRUCTIONS

■ SCREW TERMINAL

Torque : 0.5 N·m

■ SOLDERLESS TERMINAL mm (inch)

Refer to the drawing below for recommended ring tongue terminal size. Spade tongue type is also applicable. Solderless terminal:

Applicable wire size: 0.25 to 1.65 mm² (AWG 22 to 16)

Recommended manufacturer: Japan Solderless Terminal

MFG. Co., Ltd, Nichifu Co., Ltd

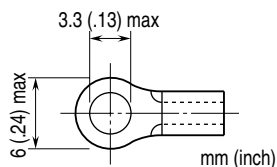

MECHATROLINK CONNECTION

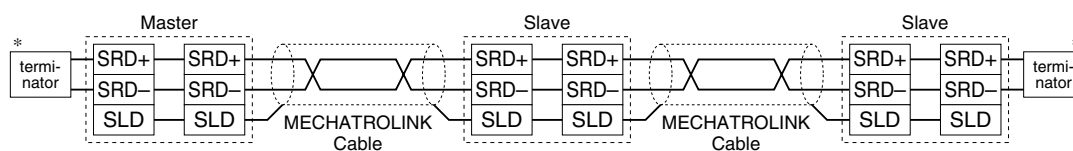

* Terminator

Be sure to connect the terminating resistors to the unit at both ends of transmission line.

Use the terminating resistor dedicated for MECHATROLINK: Model JEPMC-W6022, Yaskawa Controls Co., Ltd.

Certain types of Master units may have incorporated terminating resistors. Consult the instruction manual for the Master.

MECHATROLINK COMMUNICATION

■ MECHATROLINK-I

Baud rate: 4 Mbps

Transmission distance: 50 m max.

Distance between stations: 30 cm min.

Transmission media: MECHATROLINK cable (Model JEPMC-W6003-x-E, Yaskawa Controls Co., Ltd.)

Max. number of slaves: 15 (The maximum number of slaves might change depending on the master unit. Refer to the manual of the master unit)

Transmission cycle: 2 msec. (fixed)

Data length: 17 byte

■ MECHATROLINK-II

Baud rate: 10 Mbps

Transmission distance: 50 m max.

Distance between stations: 50 cm min.

Transmission media: MECHATROLINK cable (Model JEPMC-W6003-x-E, Yaskawa Controls Co., Ltd.)

Max. number of slaves: 30 (The maximum number of slaves might change depending on the master unit. Refer to the manual of the master unit)

Transmission cycle: 0.5 msec., 1 msec., 1.5 msec., 2 msec., 4 msec., 8 msec.

Data length: 17 bytes / 32 bytes selectable (Must choose identical data size for all stations on one network)

MECHATROLINK RELATED COMMANDS

■ MECHATROLINK DATA LINK LAYER COMMAND DESCRIPTIONS

The R7ML, Intelligent I/O, performs the connection-type communications according to MECHATROLINK protocol. The following tables explain Data Link Layer Commands supported by the R7ML.

• MDS Command (04H) Data Format

Byte	COMMAND	RESPONSE	REMARKS
0	MDS (04H)	S (0) (90H)	Message Data Search (MDS) Command: Read the ID from the slave station S (0): Response to MDS
1	0	ID1 (00H)	
2	0	ID2 (80H)	Intelligent I/O specified
3	0	0	
4	0	0	
5	0	0	
6	0	0	
7	0	0	
8	0	0	
9	0	0	
10	0	0	
11	0	0	
12	0	0	
13	0	0	
14	0	0	
15	0	0	
16	0	0	
17	0	0	Byte 17 through 31 are always 0 in the 32-byte mode.
:	:	:	These bytes are unavailable for MECHATROLINK-I, or MECHATROLINK-II in the 17-byte mode.
31	0	0	

• CDRW Command (03H) Data Format

Byte	COMMAND	RESPONSE	REMARKS
0	CDRW (03H)	ACK (01H)	Cyclic Data Read/Write (CDRW) Command: Link transmission Acknowledge (ACK): Positive response to CDRW
1	CMD	RCMD	CMD: Application Layer Command RCMD: Response to Application Layer Command
2			Byte 2 through 16 depend upon the Application Layer Command type.
:			
16			
17			
:			
31			

MECHATROLINK APPLICATION LAYER COMMAND DESCRIPTIONS

The following tables explain Application Layer Commands supported by the R7ML.

• NOP Command (00H) Data Format

Byte	COMMAND	RESPONSE	REMARKS
0	CDRW (03H)	ACK (01H)	Cyclic Data Read/Write (CDRW) Command: Link transmission Acknowledge (ACK): Positive response to CDRW
1	NOP (00H)	NOP (00H)	No Operation (NOP) Command: Nothing is performed.
2	0	ALARM	Error code: See “MECHATROLINK DATA DESCRIPTIONS”
3	0	STATUS1	Status code: See “MECHATROLINK DATA DESCRIPTIONS”
4	0	STATUS2	Status code: See “MECHATROLINK DATA DESCRIPTIONS”
5	0	0	
6	0	0	
7	0	0	
8	0	0	
9	0	0	
10	0	0	
11	0	0	
12	0	0	
13	0	0	
14	0	0	
15	0	0	
16	0	0	
17	0	0	Byte 17 through 31 are always 0 in the 32-byte mode.
:	:	:	These bytes are unavailable for MECHATROLINK-I, or MECHATROLINK-II in the 17-byte mode.
31	0	0	

• ID_RD Command (03H) Ddata Format

Byte	COMMAND	RESPONSE	REMARKS
0	CDRW (03H)	ACK (01H)	Cyclic Data Read/Write (CDRW) Command: Link transmission Acknowledge (ACK): Positive response to CDRW
1	ID_RD (03H)	ID_RD (03H)	Read ID (ID_RD) Command: Read out the device ID
2	0	ALARM	Error code: See “MECHATROLINK DATA DESCRIPTIONS”
3	0	STATUS1	Status code: See “MECHATROLINK DATA DESCRIPTIONS”
4	0	STATUS2	Status code: See “MECHATROLINK DATA DESCRIPTIONS”
5	DEVICE_CODE	DEVICE_CODE	Specifies the device code 00H: Product’s model number 0FH: Vendor code
6	OFFSET	OFFSET	Indicates where to start reading in the specified device ID
7	SIZE	SIZE	Number of byte counts to read
8	0	ID1	ASCII or binary data
9	0	ID2	ASCII or binary data
10	0	ID3	ASCII or binary data
11	0	ID4	ASCII or binary data
12	0	ID5	ASCII or binary data
13	0	ID6	ASCII or binary data
14	0	ID7	ASCII or binary data
15	0	ID8	ASCII or binary data
16	0	0	
17	0	0	Byte 17 through 31 are always 0 in the 32-byte mode.
:	:	:	These bytes are unavailable for MECHATROLINK-I, or MECHATROLINK-II in the 17-byte mode.
31	0	0	

• CONNECT Command (0EH) Data Format

Byte	COMMAND	RESPONSE	REMARKS
0	CDRW (03H)	ACK (01H)	Cyclic Data Read/Write (CDRW) Command: Link transmission Acknowledge (ACK): Positive response to CDRW
1	CONNECT (0EH)	CONNECT (0EH)	Establish Connection (CONNECT) Command: Requests to establish connection to MECHATROLINK
2	0	ALARM	Error code: See "MECHATROLINK DATA DESCRIPTIONS"
3	0	STATUS1	Status code: See "MECHATROLINK DATA DESCRIPTIONS"
4	0	STATUS2	Status code: See "MECHATROLINK DATA DESCRIPTIONS"
5	VER	VER	Application Layer version number 10H: MECHATROLINK-I 21H: MECHATROLINK-II
6	COM_MODE	COM_MODE	Communication mode 00H: 17-byte mode 80H: 32-byte mode
7	COM_TIME	COM_TIME	Communication cycle (milliseconds) MECHATROLINK-I: Multiples of two (2) MECHATROLINK-II: Integral multiples of the transmission cycle
8	0	0	
9	0	0	
10	0	0	
11	0	0	
12	0	0	
13	0	0	
14	0	0	
15	0	0	
16	0	0	
17	0	0	Byte 17 through 31 are always 0 in the 32-byte mode.
:	:	:	These bytes are unavailable for MECHATROLINK-I, or MECHATROLINK-II in the
31	0	0	17-byte mode.

• DISCONNECT Command (0FH) Data Format

Byte	COMMAND	RESPONSE	REMARKS
0	CDRW (03H)	ACK (01H)	Cyclic Data Read/Write (CDRW) Command: Link transmission Acknowledge (ACK): Positive response to CDRW
1	DISCONNECT (0FH)	DISCONNECT (0FH)	Release Connection (DISCONNECT) Command: Requests to release connection to MECHATROLINK
2	0	ALARM	Error code: See "MECHATROLINK DATA DESCRIPTIONS"
3	0	STATUS1	Status code: See "MECHATROLINK DATA DESCRIPTIONS"
4	0	STATUS2	Status code: See "MECHATROLINK DATA DESCRIPTIONS"
5	0	0	
6	0	0	
7	0	0	
8	0	0	
9	0	0	
10	0	0	
11	0	0	
12	0	0	
13	0	0	
14	0	0	
15	0	0	
16	0	0	
17	0	0	Byte 17 through 31 are always 0 in the 32-byte mode.
:	:	:	These bytes are unavailable for MECHATROLINK-I, or MECHATROLINK-II in the
31	0	0	17-byte mode.

• DATA_RWA Command (50H) Data Format

Byte	COMMAND	RESPONSE	REMARKS
0	CDRW (03H)	ACK (01H)	Cyclic Data Read/Write (CDRW) Command: Link transmission Acknowledge (ACK): Positive response to CDRW
1	DATA_RWA (50H)	DATA_RWA (50H)	Data Read/Write_A (DATA_RWA) Command: Refreshes I/O data
2	0	ALARM	Error code: See "MECHATROLINK DATA DESCRIPTIONS"
3	0	STATUS1	Status code: See "MECHATROLINK DATA DESCRIPTIONS"
4	0	STATUS2	Status code: See "MECHATROLINK DATA DESCRIPTIONS"
5	CH1 OUT LO	CH1 IN LO	CHx OUT: Output data: See "MECHATROLINK DATA DESCRIPTIONS" CHx IN: Input data: See "MECHATROLINK DATA DESCRIPTIONS"
6	CH1 OUT HI	CH1 IN HI	
7	CH2 OUT LO	CH2 IN LO	
8	CH2 OUT HI	CH2 IN HI	
9	CH3 OUT LO	CH3 IN LO	
10	CH3 OUT HI	CH3 IN HI	
11	CH4 OUT LO	CH4 IN LO	
12	CH4 OUT HI	CH4 IN HI	
13	EXT OUT LO	EXT IN LO	EXT OUT: Extension output data: See "MECHATROLINK DATA DESCRIPTIONS"
14	EXT OUT HI	EXT IN HI	EXT IN: Extension input data: See "MECHATROLINK DATA DESCRIPTIONS"
15	0	STATUS LO	R7ML status: See "MECHATROLINK DATA DESCRIPTIONS"
16	0	STATUS HI	
17	0	0	Byte 17 through 31 are always 0 in the 32-byte mode. These bytes are unavailable for MECHATROLINK-I, or MECHATROLINK-II in the 17-byte mode.
:	:	:	
31	0	0	

■ MECHATROLINK APPLICATION LAYER DATA DESCRIPTIONS

• Alarm Error Codes

Errors detected at the slave are set at ALARM in the response and sent to the master.

ERROR CODE	DESCRIPTION	CLASSIFICATION
00H	Normal status	----
01H	Invalid Command: Command is not supported.	Warning
02H	Command Not Allowed: Command execution conditions are not met.	Warning
03H	Invalid Data: Data in the command is not correct.	Warning
04H	Synchronization Error	Alarm

• STATUS1 Bit Allocations

Alarm/Warning classification and status information are set at STATUS1 in the response and sent to the master.

Bit	DEFINITION	DESCRIPTION
0	Alarm Bit	0 : Normal, 1 : Alarm
1	Warning Bit	0 : Normal, 1 : Warning
2	Command Ready Bit	0 : Command cannot be accepted (busy), 1 : Command can be accepted (ready)
3...7	Unused	----

• STATUS2

Reserved for future use

• Input Data

Input data to be sent from the slave to the master are set in the response. With an output module, output data in the command are repeated and sent back to the master.

ID	DESCRIPTION	REMARKS
CH1 IN LO	CH1 data, low 8 bits	R7ML-DA16: Bit 0 through 7 data are set. R7ML-DC16x, R7ML-YS2, R7ML-YV2: Output data are repeated.
CH1 IN HI	CH1 data, high 8 bits	R7ML-DA16: Bit 8 through 15 data are set. R7ML-DC16x, R7ML-YS2, R7ML-YV2: Output data are repeated.
CH2 IN LO	CH2 data, low 8 bits	R7ML-DA16, R7ML-DC16x: Unused R7ML-YS2, R7ML-YV2: Output data are repeated.
CH2 IN HI	CH2 data, high 8 bits	R7ML-DA16, R7ML-DC16x: Unused R7ML-YS2, R7ML-YV2: Output data are repeated.
CH3 IN LO	CH3 data, low 8 bits	R7ML-DA16, R7ML-DC16x, R7ML-YS2, R7ML-YV2 : Unused
CH3 IN HI	CH3 data, high 8 bits	R7ML-DA16, R7ML-DC16x, R7ML-YS2, R7ML-YV2 : Unused
CH4 IN LO	CH4 data, low 8 bits	R7ML-DA16, R7ML-DC16x, R7ML-YS2, R7ML-YV2 : Unused
CH4 IN HI	CH4 data, high 8 bits	R7ML-DA16, R7ML-DC16x, R7ML-YS2, R7ML-YV2 : Unused

• Output Data

Output data to be sent from the master to the slave are set in the command. Unused with all input modules.

ID	DESCRIPTION	REMARKS
CH1 OUT	CH1 data, low 8 bits	R7ML-DC16x: Bit 0 through 7 data are set.
CH1 OUT HI	CH1 data, high 8 bits	R7ML-DC16x: Bit 8 through 15 data are set.
CH2 OUT LO	CH2 data, low 8 bits	R7ML-DC16x: Unused
CH2 OUT HI	CH2 data, high 8 bits	R7ML-DC16x: Unused
CH3 OUT LO	CH3 data, low 8 bits	R7ML-DC16x, R7ML-YS2, R7ML-YV2 : Unused
CH3 OUT HI	CH3 data, high 8 bits	R7ML-DC16x, R7ML-YS2, R7ML-YV2 : Unused
CH4 OUT LO	CH4 data, low 8 bits	R7ML-DC16x, R7ML-YS2, R7ML-YV2 : Unused
CH4 OUT HI	CH4 data, high 8 bits	R7ML-DC16x, R7ML-YS2, R7ML-YV2 : Unused

• Extension Input Data

Input data of the extension module to be sent from the slave to the master are set in the response. With an output extension module, output data in the command are repeated and sent back to the master.

ID	DESCRIPTION	REMARKS
EXT IN LO	Extension data, low 8 bits	R7ML-EA16, R7ML-EA8: Bit 0 through 7 data are set. R7ML-EC16x, R7ML-EC8x: Output data are repeated.
EXT IN HI	Extension data, high 8 bits	R7ML-EA16: Bit 8 through 15 data are set. R7ML-EC16x: Output data are repeated. R7ML-EA8, R7ML-EC8x: Unused

• Extension Output Data

Output data to be sent from the master to the slave are set in the command. Unused with all input modules.

ID	DESCRIPTION	REMARKS
EXT OUT LO	Extension data, low 8 bits	R7ML-EC16x: Bit 0 through 7 data are set. R7ML-EC8x: Bit 0 through 7 data are set.
EXT OUT HI	Extension data, high 8 bits	R7ML-EC16x: Bit 8 through 15 data are set. R7ML-EC8x: Unused

• R7ML Status Data

Status data to be sent from the slave to the master are set in the response. Refer to “I/O DATA DESCRIPTIONS.”

I/O DATA DESCRIPTION

■ DISCRETE INPUT

