

2-WIRE POSITION TRANSMITTER
(rotary motion type; 90-degree rotation)

MODEL **VOS2T-R**

BEFORE USE

Thank you for choosing us. Before use, please check contents of the package you received as outlined below. If you have any problems or questions with the product, please contact our sales office or representatives.

■ PACKAGE INCLUDES:

- VOS2T-R unit(1)
- Cable, approx. 1 meter long (optional)(1)
- Cable connector (optional)(1)
- Lever assembly
 - Lever(1)
 - Connecting pin(1)
 - Nailed nut(1)
 - Nut with washer (M5)(1)
- Screws for attaching the lever (M5 × 8)(1)
- Plain washer (M5)(1)
- Toothed washer (M5, external teeth)(1)
- Toothed washer (M5, internal teeth)(1)

Note: Bracket, link and other components necessary to attach the VOS2T-R to an actuator are to be provided by the customer.
Link Set (model: VOLK) is available to simplify the connection.

■ MODEL NO.

Confirm Model No. marking on the product to be exactly what you ordered.

POINTS OF CAUTION

■ CONFORMITY WITH EU DIRECTIVES

- When the unit is mounted onto a grounded metal bracket, insert a noise filter for the output. COSEL Noise Filter Model NAC-04-472 or equivalent is recommended.

■ GENERAL PRECAUTION

- Cut power supply to the unit before wiring to it.

■ ENVIRONMENT

- Inside building. If outside, keep away from direct sunlight.
- Operating temperature -5 to +60°C (23 to 140°F)
- Operating humidity 30 to 90% RH

■ ACTUATOR SIDE LEVER

- When the actuator side lever is provided by the customer, be sure that diameter of the hole threading the connecting pin is 5 millimeters or wider. Diameter of connecting pin: 5⁰_{-0.03} mm

■ GASKET

- Be sure to return the gasket when you close the unit cover after wiring or adjustments.

■ TORQUE

- For the screws attached to the cover, tightening torque is between 1.2 and 1.6 N·m.

COMPONENT IDENTIFICATION

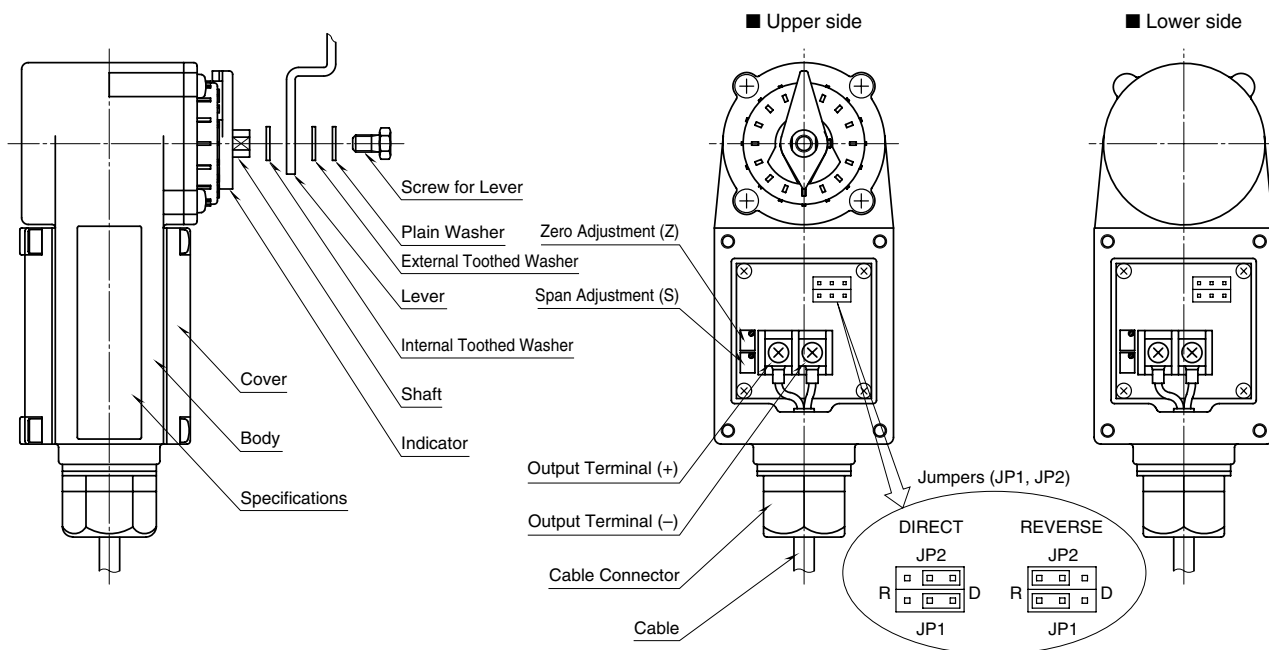

Figure 1

INSTALLATION

■ LINKING WITH LEVERS

• POSITIONING THE VOS2T-R SECURELY

The output accuracy of the VOS2T-R is largely affected by its mechanical position relative to the actuator.

The VOS2T-R and the actuator respectively must be positioned so that the distance between the centers of VOS2T-R shaft and the actuator stem (A – C) be equal to the length of the actuator lever (B – D) as in Figure 2.

The length of actuator lever for the VOLK can be adjusted. Refer to the “ADJUSTMENT PROCEDURE” section.

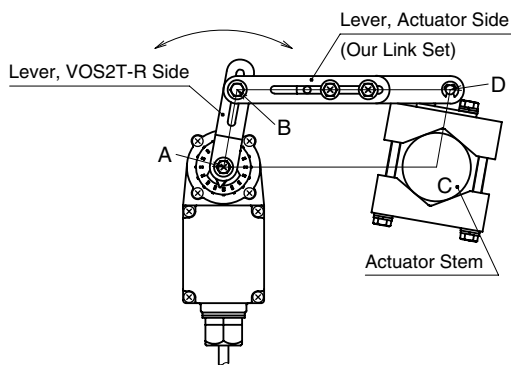

Figure 2

• CONNECTING THE VOS2T-R SIDE LEVER

Connect the lever to the VOS2T-R unit with a screw included in the package, with a plain washer and a toothed washer between them as in Figure 1. At this stage, you do not have to fasten the screw tightly.

• CONNECTING THE VOS2T-R SIDE LEVER TO THE ACTUATOR SIDE LEVER (with the actuator side lever provided by the customer)

Attach the connecting pin to the VOS2T-R side lever utilizing the nailed nut and the nut as in Figure 3. The actuator side lever should be threaded with the connecting pin but left loose. The nail could be positioned in either side of the lever, however it is limited to one side at the extreme end of the lever hole.

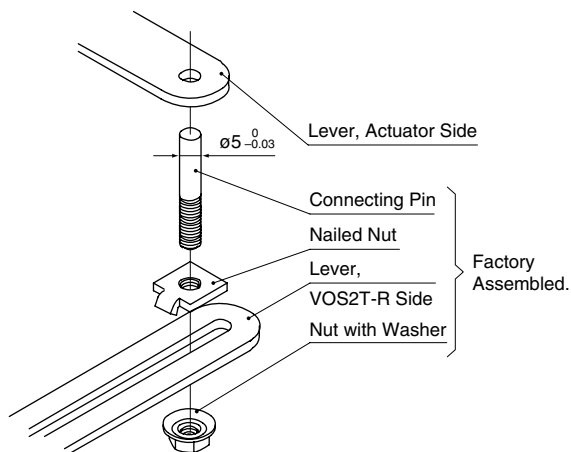

Figure 3

• CONNECTING THE VOS2T-R SIDE LEVER TO THE ACTUATOR SIDE LEVER (with VOLK by us)

Connect between the levers utilizing the nailed nut as in Figure 4. (No need of lever A on VOLK)

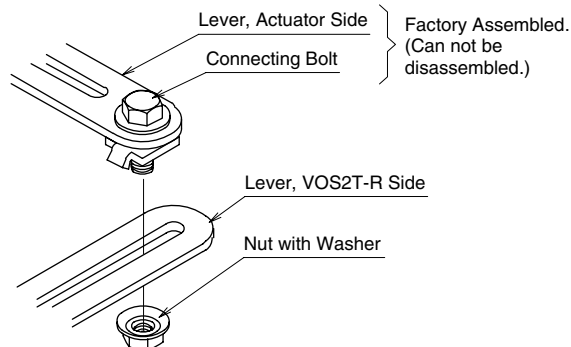

Figure 4

■ LINKING WITHOUT LEVERS

Refer to Figure 5 below when the VOS2T-R is to be connected directly to an actuator without utilizing levers. Adjust the relative positions of the actuator stem and VOS2T-R shaft so that their center positions are in a straight line, or otherwise use a coupling which can absorb position slides. Note that performance of the VOS2T-R mounted in this way is more easily affected by vibration. We recommend not to use this method when severe vibration is observed.

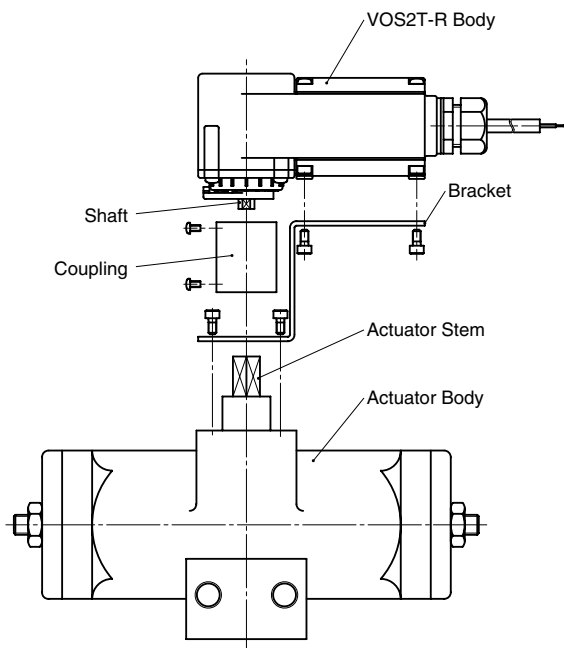

Figure 5

ELECTRICAL CONNECTIONS

Remove the VOS2T-R unit cover and wire to the terminals according to Figure 6.

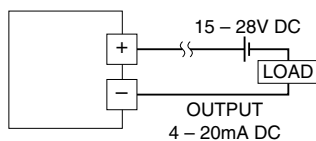

Figure 6

ADJUSTMENT PROCEDURE

First adjust the relative positions of levers and linking mechanism.

After that, open the VOS2T-R unit cover. Set the action direction* with jumpers (JP1, JP2 in Figure 1) and adjust Zero (Z) and Span (S) behind it.

*Direct action: the output increases when the shaft turns clockwise (seen from the lever side).

Reverse action: the output increases when the shaft turns counterclockwise (seen from the lever side).

HOW TO ADJUST LEVERS & LINKING MECHANISM

1) Electrical wires to the terminals should be done before this adjustment. However, do not change each potentiometer's setting yet. Leave the jumper settings for action direction as they were set at the factory (direct) at this moment.

2) For using levers to link, loosen the VOS2T-R side nut and washer and set the connecting pin (or bolt) position relative to other components so that the distance A - B and C - D is the same. See Figure 2. Tighten the nut and washer.

3) For using the VOLK in combination with the VOS2T-R lever, adjust lever length of the VOLK so that the distance A - C and B - D is also the same. (The square A-B-C-D must be a parallelogram or a rectangle.) Then tighten the bolt.

If a customer provided lever is also adjustable of its length, do the same.

4) With the actuator positioned at 50%, adjust the VOS2T-R shaft angle with a wrench (7 mm) or by twisting the indicator with your hand so that the VOS2T-R outputs approx. 12mA. If you are using levers to link, tighten the screw for lever now (torque 2.4 - 3.1 N·m). If you are not using a lever, fix the coupling now.

5) Check the indicator and adjust its angle after loosening its screw (M2.6) if necessary. Make sure that it is tightened again after adjustment.

HOW TO ADJUST ZERO AND SPAN

1) If you need reverse action, change the setting now. Remove the cover and set the jumpers JP1 and JP2 to R position according to Figure 1. Factory set zero point may be slid by changing the action direction. Re-adjust according to the following.

2) First operate the actuator slowly for full-stroke (90° or input angle after adjustment) and check that the VOS2T-R outputs approximately 0 - 100% (4 - 20mA DC) accordingly. Be sure also that the output signal increases or decreases without interruption.

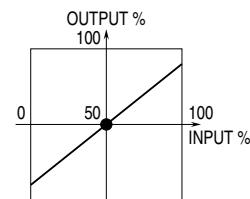

Fig. 7

3) With 50% input (actuator position), check that the output is approximately 50%. See Figure 7.

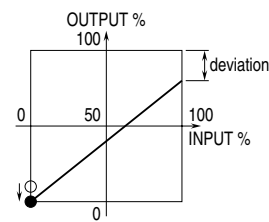

Fig. 8

4) With 0% input, adjust the output to 0% with Zero adjustment. See Figure 8.

5) Set the input to 100%. If there is a deviation in output signal, compensate half of the deviation via the Zero adjustment. See Figure 9.

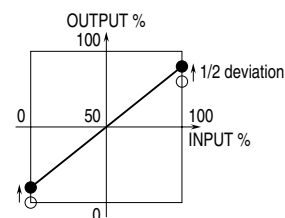

Fig. 9

6) With 100% input, adjust the other half of the deviation with Span adjustment in order to get 100% output. See Figure 10.

7) Input 0%, 50% and 100% signals and check the output according to the respective input value. If the output value is shifted, repeat the above procedure (3) - (6).

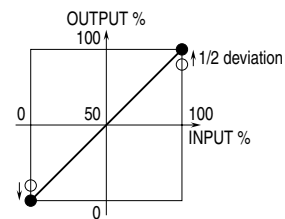

Fig. 10

Note: If you set a wider output span (narrower input span), the VOS2T-R does not output above or below the full-scale range.

MAINTENANCE

■ MECHANICAL PARTS

- Check that screws are fastened tightly and if some of them are loosened, be sure to re-tighten them.
If you find the connecting pin loose, go through “ADJUSTMENT PROCEDURE” again.
- Inspect visually that the connecting section of levers is stable and smooth. Check also that the connecting pin or lever is not worn. If it is, it must be replaced. Consult us or local representative. If the abrasion advances fairly quickly, there may be a problem in the link mechanism (e.g. connecting pin position)
- If the VOS2T-R is installed outside the building or where it is subject to water or metallic dust particles, check that there is no crack or bruise on the gasket. If you find any, consult us or local representative.
- Consult us or local representative also for inspection of packing (O-ring) in the moving parts.

■ ELECTRICAL PARTS

- Check first the mechanical parts as above.
- Change actuator positions and input 0%, 25%, 50%, 75% and 100% signals. Check the output with respective input value is within allowance indicated in the specifications. If not, go through “ADJUSTMENT PROCEDURE” again.

LIGHTNING SURGE PROTECTION

We offer a series of lightning surge protectors for protection against induced lightning surges. Please contact us to choose appropriate models.