

UNIVERSAL INPUT MODULE
(4 points, isolated, tension clamp terminal block)MODEL **R80UST4****BEFORE USE**

Thank you for choosing us. Before use, please check contents of the package you received as outlined below.

If you have any problems or questions with the product, please contact our sales office or representatives.

■ PACKAGE INCLUDES:

Universal input module(1)
CJC sensor.....(4)

■ MODEL NO.

Confirm Model No. marking on the product to be exactly what you ordered.

■ INSTRUCTION MANUAL

This manual describes necessary points of caution when you use this product, including installation, connection and basic maintenance procedures.

■ POWER UP

- Turn the power on at the same time as the power/network module or turn the R80PS1 on before the power/network module turned on. If the R80PS1 is not turned on within 3 seconds after the power/network module is turned on, I/O modules are not correctly recognized.

POINTS OF CAUTION**■ CONFORMITY WITH EU DIRECTIVES**

- The equipment must be mounted inside a panel.
- The actual installation environments such as panel configurations, connected devices, connected wires, may affect the protection level of this unit when it is integrated in a panel system. The user may have to review the CE requirements in regard to the whole system and employ additional protective measures to ensure the CE conformity.

■ GENERAL PRECAUTIONS

- Before you remove or mount the unit, turn off the power supply and output signal for safety.
- DO NOT set the switches while the power is supplied. The switches are used only for maintenance without the power.

■ ENVIRONMENT

- Indoor use.
- When heavy dust or metal particles are present in the air, install the unit inside proper housing with sufficient ventilation.
- Do not install the unit where it is subjected to continuous vibration. Do not subject the unit to physical impact.
- Environmental temperature must be within -10 to +55°C (14 to 131°F) with relative humidity within 30 to 90% RH in order to ensure adequate life span and operation.

■ WIRING

- Do not install cables close to noise sources (relay drive cable, high frequency line, etc.).
- Do not bind these cables together with those in which noises are present. Do not install them in the same duct.

INSTALLATION

■ HOW TO MOUNT THE MODULE ON DIN RAIL

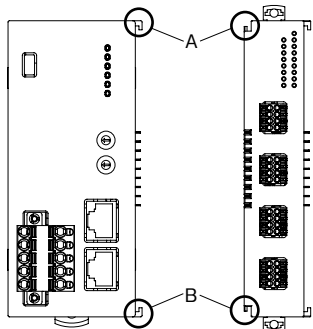

Confirm that the locking clamps of the extension power supply module are set. Insert the module in parallel to the next one while aligning the grooves of both modules (A & B in the above figure). Maintain it perpendicularly to the rail.

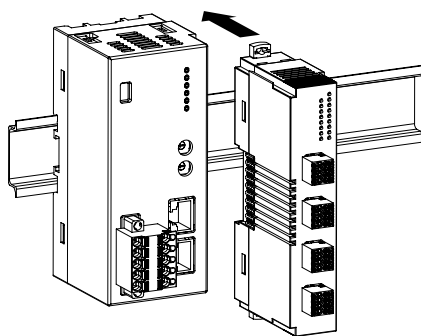

More I/O modules can be added in the same manner.

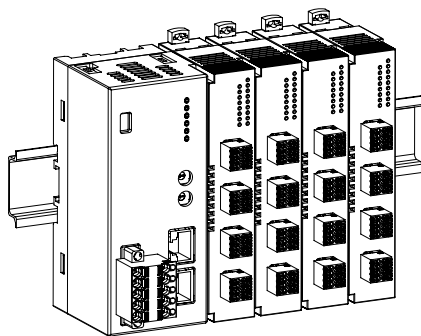

• Protective Cover

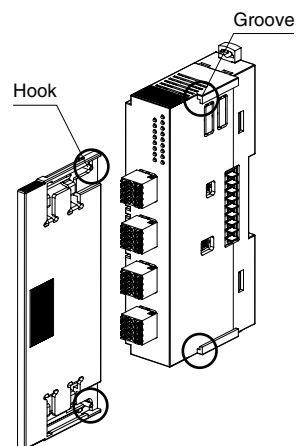

The protective cover is to be attached over the connected I/O module at the right end.

Align the hooks on the cover with the grooves of the module and slide it straight until the hooks are latched.

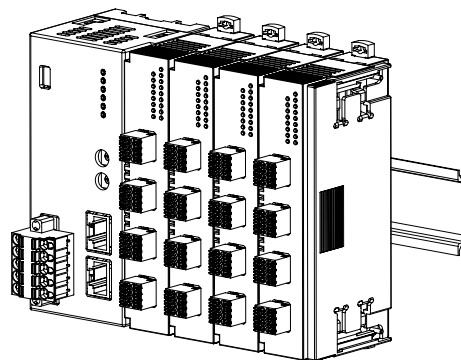

When removing the cover, pull it out while squeezing the hooks inward.

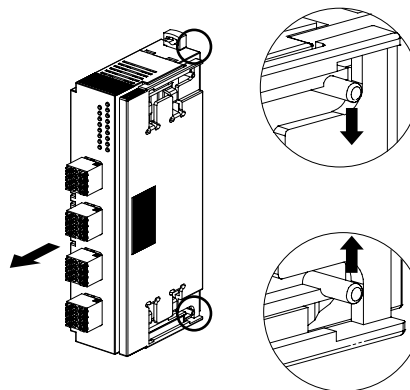

■ HOW TO UNMOUNT THE MODULE FROM DIN RAIL

Release the locking clamps and pull out straight the module.

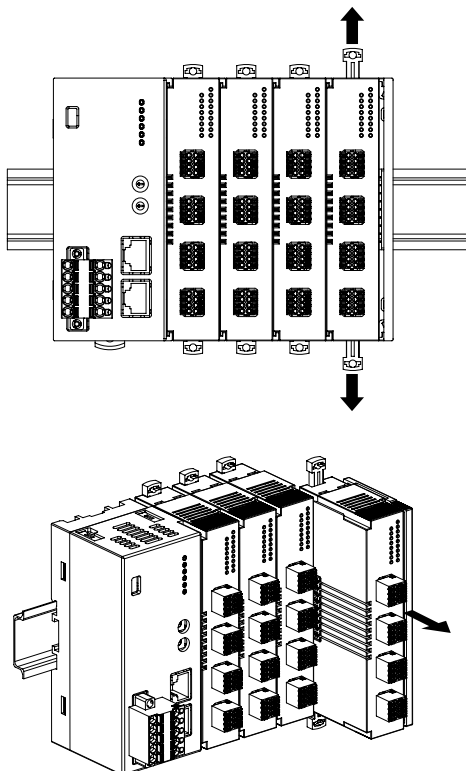

• Removing an intermediate module

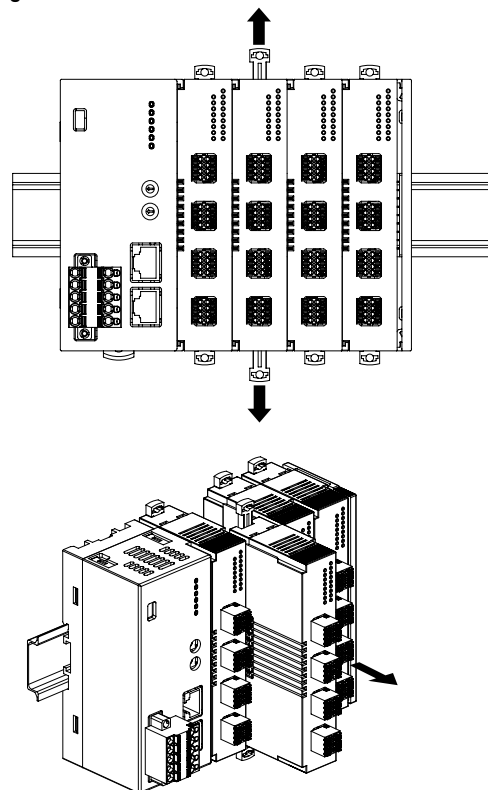

Caution !

- 1) Be careful not to hurt your hand by pointed edges of the internal bus connector.
- 2) I/O modules cannot hold tightly on the DIN rail by themselves without power/network module.
Secure them to the position if necessary by using DIN rail end plates.

COMPONENT IDENTIFICATION

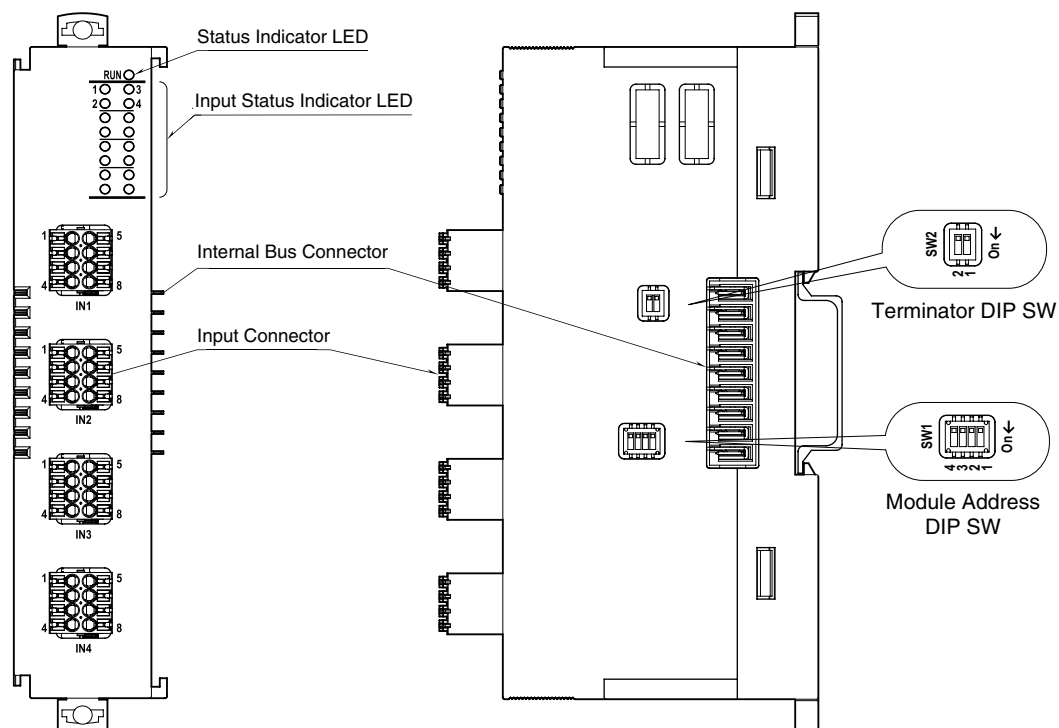

■ STATUS INDICATOR LED / INPUT STATUS INDICATOR LED

LED	OPERATION	COLOR	FUNCTION
RUN	ON	Red	Upper communication: Stopping or abnormal Internal communication: Abnormal
	ON	Green	Upper communication: Normal Internal communication: Normal
	Blink 1 sec. cycle	–	Burnout is detected or with input value error ($\leq -15\%$, $\geq +115\%$, becomes less than the lower limit or exceeds the upper limit of usable range).
	Blink 400 msec. cycle	–	Input circuit abnormality (AD converter response failure)
	OFF	–	Upper communication: Stopping or abnormal Internal communication: Normal
Input Status Indicator LED	OFF	Red	Input data in the range
	ON		Burnout is detected or with input value error ($\leq -15\%$, $\geq +115\%$, becomes less than the lower limit or exceeds the upper limit of usable range). Input circuit abnormality (AD converter response failure)

■ OPERATING MODE SETTING

(*) factory default setting

Note. Be sure to OFF the unused SW2-2.

• Module Address Setting

Configure the module address with DIP Switch.

0 - 15 are available for module address.

MODULE ADDRESS	SW1			
	1	2	3	4
0(*)	OFF	OFF	OFF	OFF
1	ON	OFF	OFF	OFF
2	OFF	ON	OFF	OFF
3	ON	ON	OFF	OFF
4	OFF	OFF	ON	OFF
5	ON	OFF	ON	OFF
6	OFF	ON	ON	OFF
7	ON	ON	ON	OFF
8	OFF	OFF	OFF	ON
9	ON	OFF	OFF	ON
10	OFF	ON	OFF	ON
11	ON	ON	OFF	ON
12	OFF	OFF	ON	ON
13	ON	OFF	ON	ON
14	OFF	ON	ON	ON
15	ON	ON	ON	ON

• Terminator Setting

Terminator	SW2-1
Disabled (*)	OFF
Enabled	ON

■ INPUT CONNECTOR TERMINAL ASSIGNMENT

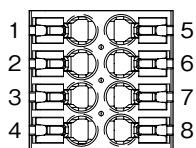

PIN NO.	ID	FUNCTION
1	U1	U1
2	NC	Unused
3	NC	Unused
4	U6	U6
5	U2	U2
6	U3	U3
7	U4	U4
8	U5	U5

• Universal input terminal assignment

ID	FUNCTION						
	Wide span voltage (-10 - +10V DC)	DC Current	Narrow span voltage (-1000 - +1000mV DC)	Thermocouple	RTD/ Resistor (3-wire)	RTD/ Resistor (2-wire)	Potentiometer
U1	Wide span voltage	-	-	-	-	-	-
U2	-	DC Current	-	-	-	-	-
U3	-	-	Narrow span voltage	Thermocouple+	RTD-b	-	Input S
U4	-	-	-	CJM	RTD-B	RTD-B	Input L
U5	Common	Common	Common	Thermocouple-	RTD-A	RTD-A	Input H
U6	-	-	-	CJM	-	-	-

PC CONFIGURATOR

The following parameters can be set with using PC Configurator Software (model: R80CFG)
Refer to the users manual for the R80CFG for detailed operation of the software program.

■ CHANNEL INDIVIDUAL SETTING

ITEM	SETTING RANGE		DEFAULT VALUE
Unused setting	CH enabled CH disabled		CH enabled
Input type	DC voltage	-10 - +10 V DC -1000 - +1000 mV DC	-10 - +10 V DC
	DC current	-20 - +20 mA DC	
	Potentiometer	POT 0 - 4000 Ω POT 0 - 2500 Ω POT 0 - 1200 Ω POT 0 - 600 Ω POT 0 - 300 Ω POT 0 - 150 Ω	
	Resistpr	OHM 0 - 4000 Ω	
	RTD	RTD Pt 100 RTD Pt 500 RTD Pt 1000 RTD Pt 50 Ω RTD JPt 100 RTD Ni 508.4 Ω RTD Cu 10	
	Thermocouple	TC (PR) TC K TC E TC J TC T TC B TC R TC S TC C TC N TC U TC L TC P	
Wiring	2-wire 3-wire		-
Burnout	Upscale Downscale None		-
CJC	Enabled Disabled		-
Temp. unit	degC degF K		-
Zero fine adj.	-320.00 - +320.00 (%)		0.00 (%)
Gain fine adj.	-3.2000 - +3.2000		1.0000
Zero base	depends on input types*1		0.000
Full base	depends on input types*1		0.000
Zero scaling	-32,000 - +32,000		0
Full scaling	-32,000 - +32,000		10,000
First order lag filter	0.0, 0.5 - 60.0 (sec.)		0.0 (sec.)

*1. For details, refer to the users manual of R80CFG

■ CHANNEL BATCH SETTING

ITEM	SETTING RANGE	DEFAULT VALUE
Version no.	-	-
Simulate input	Normal input Simulated data	Normal input

TERMINAL CONNECTIONS

Connect the unit as in the diagram below.

For thermocouple input, attach the CJC sensor together with input wiring to the input screw terminals.

EXTERNAL DIMENSIONS unit : mm (inch)

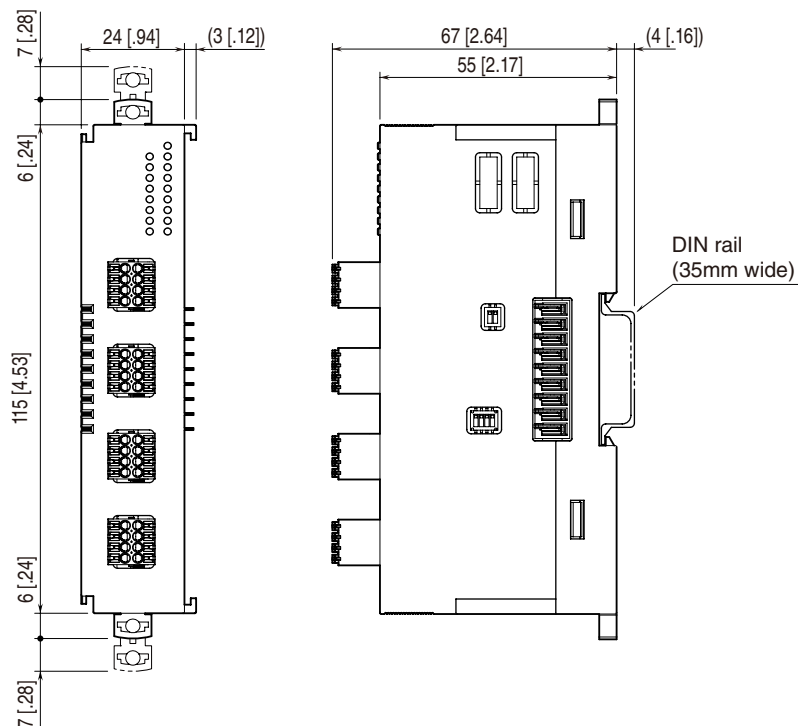

■ CONNECTION DIAGRAM

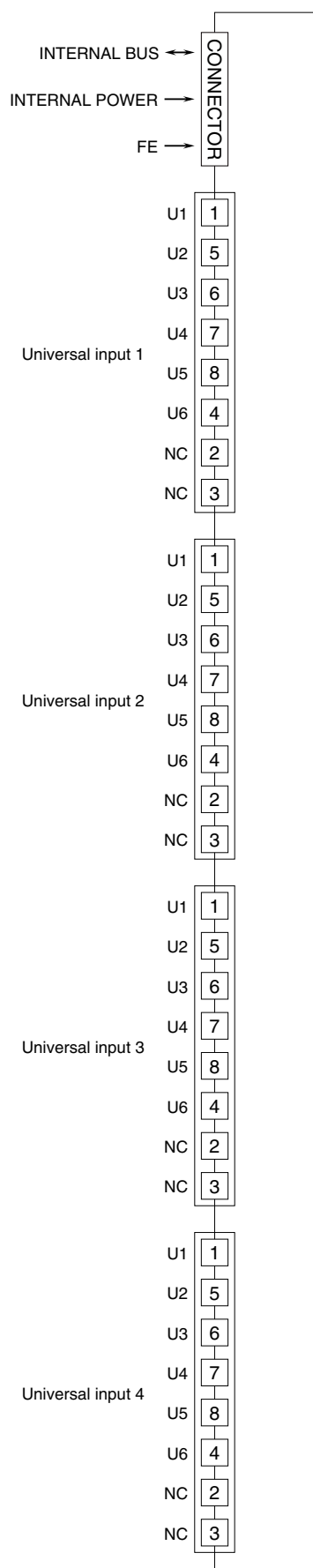

■ UNIVERSAL INPUT CONNECTION

• DC Voltage (-10 – +10V DC)

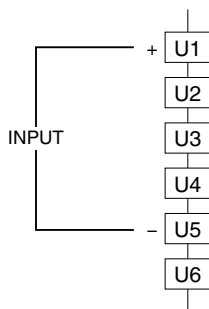

• DC Current (0 – 20mA DC)

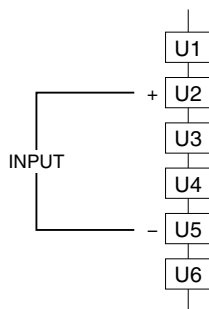

• DC Voltage (-1000 – +1000mV DC)

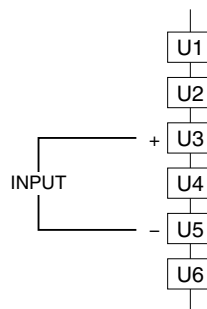

• Thermocouple

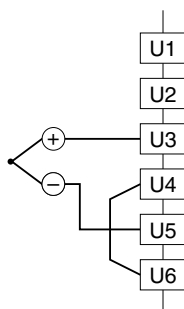

• RTD or Resistor (3-wire)

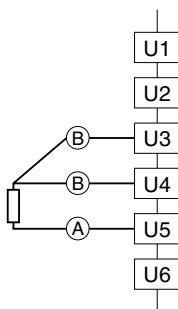

• RTD or Resistor (2-wire)

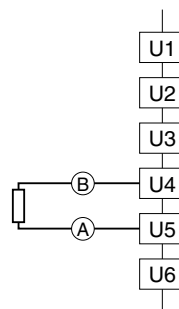

• Potentiometer

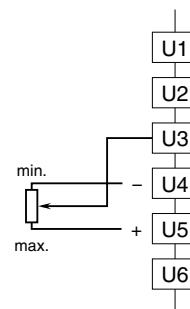

WIRING INSTRUCTIONS

■ TENTION CLAMP TERMINAL BLOCK

Unit side connector: DMC0,5/4-G1-2,54 P20THR R44

(Phoenix Contact)

Cable side connector: DFMC0,5/4-ST-2,54

(Phoenix Contact)

Applicable wire size: 0.14 – 0.5 mm²

Stripped length: 7 mm

Recommended solderless terminal

- AI0,14-6GY0.14mm²(Phoenix Contact)
- AI0,25-6YE0.25mm²(Phoenix Contact)
- A0,34-70.34mm²(Phoenix Contact)