

MULTI POWER MONITORING UNIT
(clamp-on current sensor CLSE, LonWORKS)MODEL **R9LWTU****BEFORE USE**

Thank you for choosing us. Before use, please check contents of the package you received as outlined below.

If you have any problems or questions with the product, please contact our sales office or representatives.

■ PACKAGE INCLUDES:

Multi power monitoring unit.....(1)
Upper mounting adaptor.....(2)
Neuron ID label.....(2)

■ MODEL NO.

Confirm Model No. marking on the product to be exactly what you ordered.

■ INSTRUCTION MANUAL

This manual describes necessary points of caution when you use this product, including installation, connection and basic maintenance procedures.

This unit is configured by using LonMaker. Configurator Software (Model: PMCFG) can use only "monitoring measured values". The XIF files and the PMCFG PC Configurator Software is downloadable at our web site.

POINTS OF CAUTION**■ AUXILIARY POWER INPUT RATING & OPERATIONAL RANGE**

- Locate the auxiliary power input rating marked on the product and confirm its operational range as indicated below:

100 – 240V AC rating: 85 – 264V, 50/60 Hz, < 9VA

110 – 240V DC rating: 99 – 264V, < 3W

■ GENERAL PRECAUTIONS

- Before you remove or mount the unit, turn off the power supply and input signal for safety.
- DO NOT set the switches on the module while the power is supplied. The switches are used only for maintenance without the power.

■ ENVIRONMENT

- Indoor use.
- Do not install the unit where it is directly exposed to rain, water droplets or sunlight.
- When heavy dust or metal particles are present in the air, install the unit inside proper housing with sufficient ventilation.
- Do not install the unit where it is subjected to continuous vibration. Do not subject the unit to physical impact.
- Environmental temperature must be within -10 to +55°C (14 to 131°F) with relative humidity within 30 to 90% RH in order to ensure adequate life span and operation.

■ WIRING

- Wiring to the unit must be conducted by qualified service personnel.
- Do not install cables close to noise sources (relay drive cable, high frequency line, etc.).
- Do not bind these cables together with those in which noises are present. Do not install them in the same duct.

■ AND



- The unit is designed to function as soon as power is supplied, however, a warm up for 10 minutes is required for satisfying complete performance described in the data sheet.

COMPONENT IDENTIFICATION

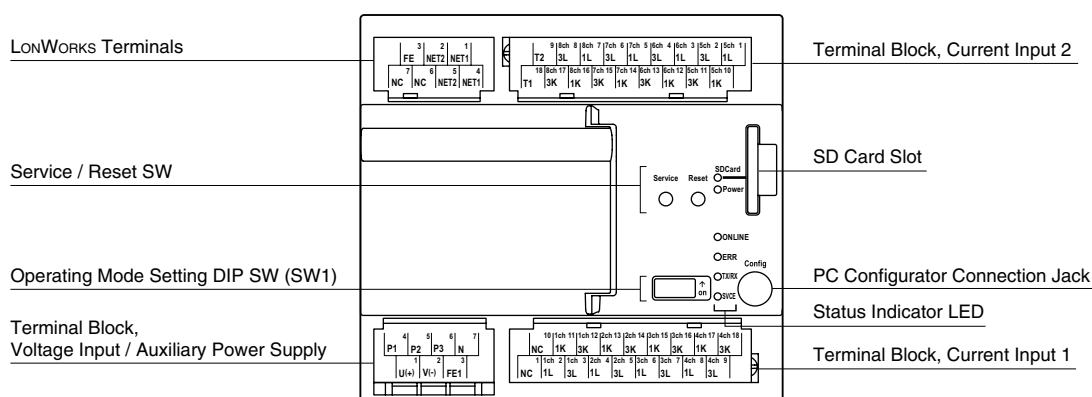
FRONT VIEW

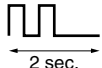

STATUS INDICATOR LED

ID	COLOR	STATE	FUNCTION
SDCard	Red	Blinking approx. 1 Hz	The unit is preparing to write. The LED starts blinking 30 seconds before the unit starts writing in the SD card on the hour every hour. DO NOT extract the card while the LED shows the blinking pattern until the writing is complete.
			SD card access error. The unit is unable to normally write in the card because it is full or its data contents are damaged.
			SD card partial access error. The unit was unable to write in the card for unknown reason but now is recovered. A part of the data contents is missing.
		OFF	SD card not inserted.
		ON	SD card inserted.
		Blinking approx. 2 Hz	The unit is writing in the SD card. DO NOT extract the card.
Power	Red	ON	Normal
		Blinking approx. 0.5 Hz	Input overload or no input
		Blinking approx. 2 Hz	Setting error or device error
			Internal calendar error or calendar backup battery life expired. Re-set the calendar with the PC Configurator. The LED blinks in the designated pattern every time when the power is turned on after the battery life has been expired.
		OFF	Device error
ONLINE	Red	ON	Online
		Blinking approx. 2 Hz	Receiving Wink Message
		OFF	Abnormal state
ERR	Red	ON	Received data error
TX/RX	Red	ON	Sending/receiving Network Variables
		OFF	Communication is lost.
SVCE	Red	ON	Internal program error
		Blinking approx. 0.5 Hz	No network information
		OFF	Normal state

■ SERVICE SWITCH

Used to identify the node in LONWORKS network configuration.

■ RESET SWITCH

Used to reset the Neuron Chip. Press the switch behind the front cover to reset.

Control functions are halted while completing resetting and restarting. Confirm no danger before conducting resetting.

■ OPERATING MODE SETTING

(*) Factory setting

• System Configuration (SW1-1, 2)

SW1-1	SW1-2	SYSTEM CONFIGURATION
OFF	OFF	Three-phase / 3-wire (*)
ON	OFF	Single-phase / 2-wire
OFF	ON	Single-phase / 3-wire
ON	ON	---

• Balanced or Unbalanced Load (SW1-3)

SW1-3	BALANCED / UNBALANCED
OFF	Unbalanced (*)
ON	Balanced

■ TERMINAL ASSIGNMENTS

• Network

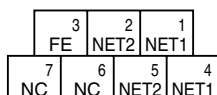

No.	ID	FUNCTION
1	NET1	LONWORKS comm. 1
2	NET2	LONWORKS comm. 2
3	FE	Comm. ground
4	NET1	LONWORKS comm. 1
5	NET2	LONWORKS comm. 2
6	NC	Unused
7	NC	Unused

• Current Input 2

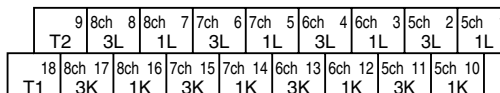

No.	ID	FUNCTION	No.	ID	FUNCTION
1	5ch 1L	Ch.5, Current input 1L	10	5ch 1K	Ch.5, Current input 1K
2	5ch 3L	Ch.5, Current input 3L	11	5ch 3K	Ch.5, Current input 3K
3	6ch 1L	Ch.6, Current input 1L	12	6ch 1K	Ch.6, Current input 1K
4	6ch 3L	Ch.6, Current input 3L	13	6ch 3K	Ch.6, Current input 3K
5	7ch 1L	Ch.7, Current input 1L	14	7ch 1K	Ch.7, Current input 1K
6	7ch 3L	Ch.7, Current input 3L	15	7ch 3K	Ch.7, Current input 3K
7	8ch 1L	Ch.8, Current input 1L	16	8ch 1K	Ch.8, Current input 1K
8	8ch 3L	Ch.8, Current input 3L	17	8ch 3K	Ch.8, Current input 3K
9	T2	Unused	18	T1	Unused

• Auxiliary Power Supply, Voltage Input

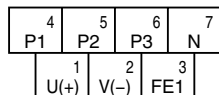

No.	ID	FUNCTION
1	U(+)	Auxiliary power (+)
2	V(-)	Auxiliary power (-)
3	FE1	Power ground
4	P1	Voltage input P1
5	P2	Voltage input P2
6	P3	Voltage input P3
7	N	Voltage input N

• Current Input 1

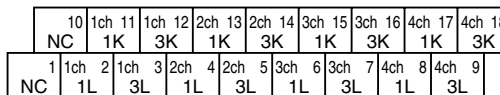

No.	ID	FUNCTION	No.	ID	FUNCTION
1	NC	Unused	10	NC	Unused
2	1ch 1L	Ch.1, Current input 1L	11	1ch 1K	Ch.1, Current input 1K
3	1ch 3L	Ch.1, Current input 3L	12	1ch 3K	Ch.1, Current input 3K
4	2ch 1L	Ch.2, Current input 1L	13	2ch 1K	Ch.2, Current input 1K
5	2ch 3L	Ch.2, Current input 3L	14	2ch 3K	Ch.2, Current input 3K
6	3ch 1L	Ch.3, Current input 1L	15	3ch 1K	Ch.3, Current input 1K
7	3ch 3L	Ch.3, Current input 3L	16	3ch 3K	Ch.3, Current input 3K
8	4ch 1L	Ch.4, Current input 1L	17	4ch 1K	Ch.4, Current input 1K
9	4ch 3L	Ch.4, Current input 3L	18	4ch 3K	Ch.4, Current input 3K

• Clamp Sensor Type (SW1-4, 5, 6)

SW1-4	SW1-5	SW1-6	CLAMP SENSOR TYPE
OFF	OFF	OFF	CLSE-R5 (5A) (*)
ON	OFF	OFF	CLSE-05 (50A)
OFF	ON	OFF	CLSE-10 (100A)
OFF	OFF	ON	CLSE-20 (200A)
ON	ON	OFF	CLSE-40 (400A)
OFF	ON	ON	CLSE-60 (600A)

• Configuration Mode (SW1-8)

SW1-8	CONFIGURATION MODE
OFF	DIP switch setting (*) (LonMaker setting is invalid.)
ON	PC Configurator and communication (LonMaker setting is invalid.)

Note 1: Be sure to set unused SW1-7 to OFF.

Note 2: Clamp sensor type setting is common to all circuits.

Note 3: The sensor type and other settings for individual circuit can be performed on the LonMaker.

INSTALLATION

■ WALL MOUNTING

Attach the upper mounting adaptors to the upper side of the unit, and pull out the lower mounting adaptors from the lower side. Fasten a M4 screw through the mounting hole (4.5 mm dia.) of each adaptor. (torque 1.4 N·m)

To remove the upper mounting adaptor from the unit, pull it out while squeezing the latches as shown in the figure below.

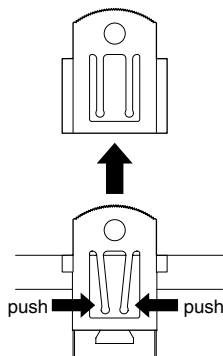

■ DIN RAIL MOUNTING

Set the unit so that the lower mounting adaptors are at the bottom. Hook the upper hook at the rear side of the unit onto the DIN rail and push in the lower part of the unit. When removing the unit, pull out the unit while pushing down the adaptors using a minus screwdriver.

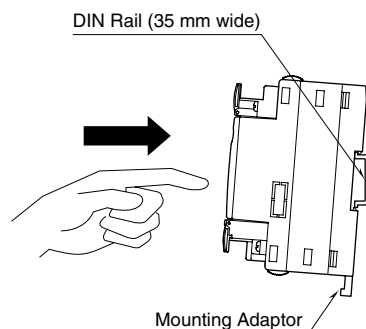

TERMINAL CONNECTIONS

Connect the unit as in the diagram below.

■ EXTERNAL DIMENSIONS unit: mm (inch)

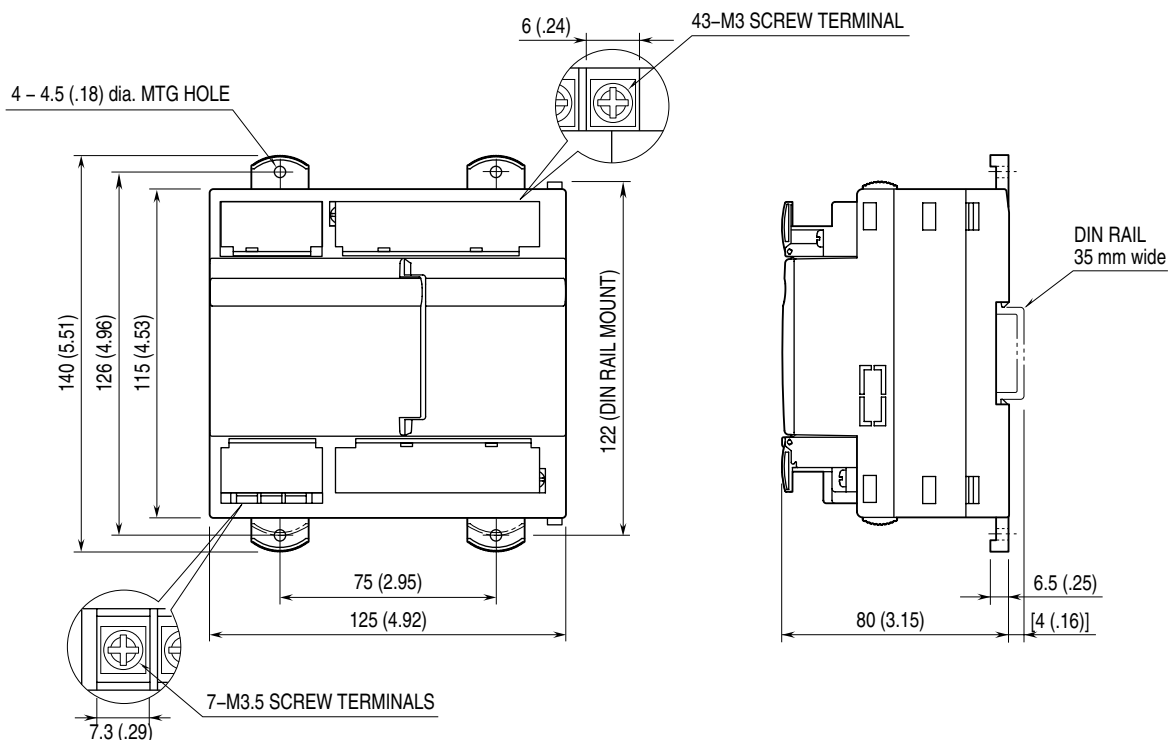

■ CONNECTION DIAGRAM

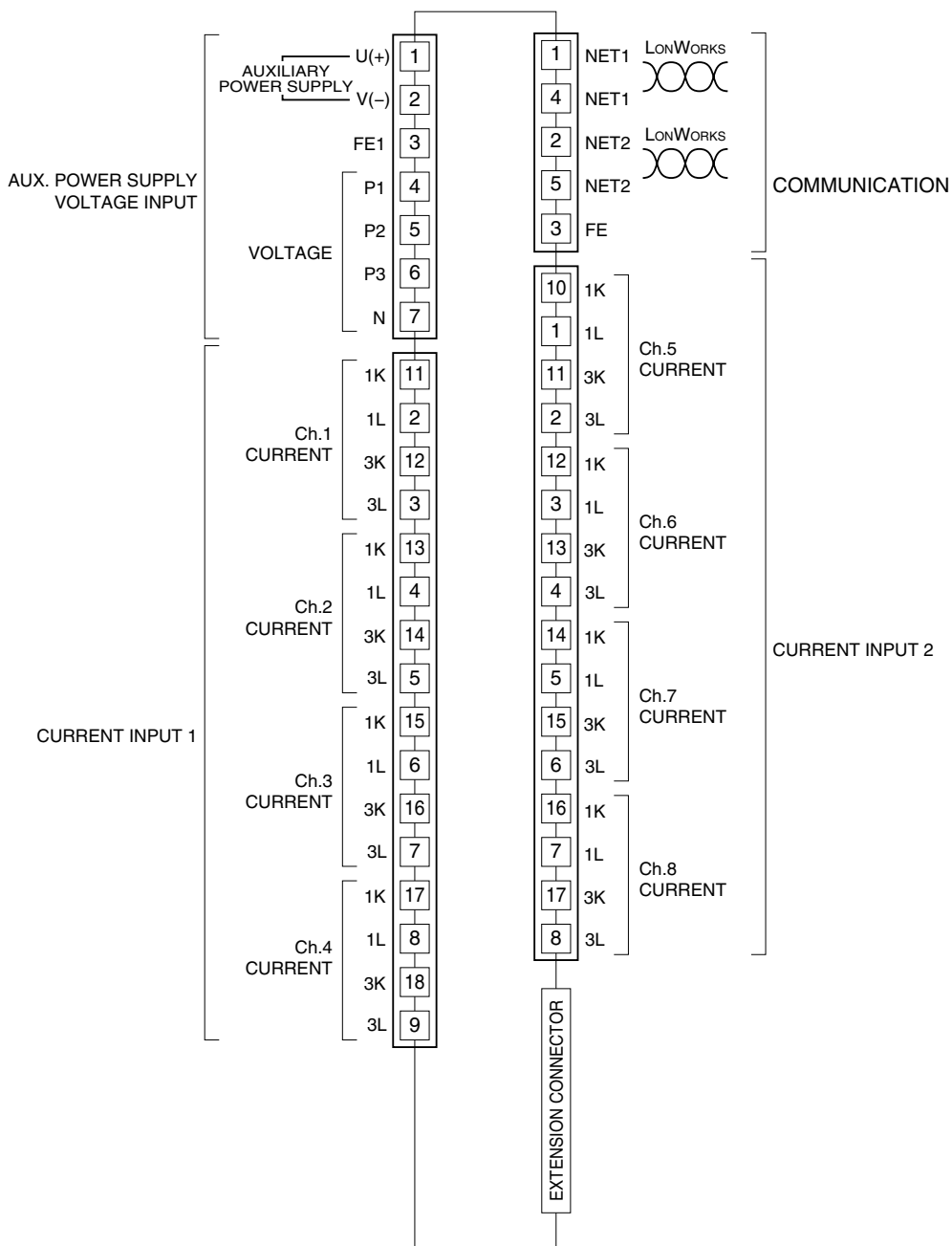

INPUT WIRING

Use the model CLSE clamp sensor for current inputs.

The figure below shows only one circuit.

A maximum of eight (8) current sensor inputs can be connected (Ch. 1 through Ch. 8).

Grounding is not required for low voltage circuits.

System / Application	Terminal	System / Application	Terminal
Single-phase / 2-wire		Three-phase / 3-wire balanced load	
Single-phase / 3-wire		Three-phase / 3-wire unbalanced load	

MOUNTING REQUIREMENTS unit: mm (inch)

SINGLE MOUNTING

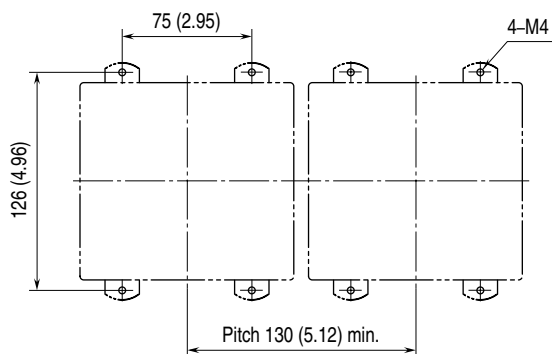

BASIC + EXTENSION UNIT

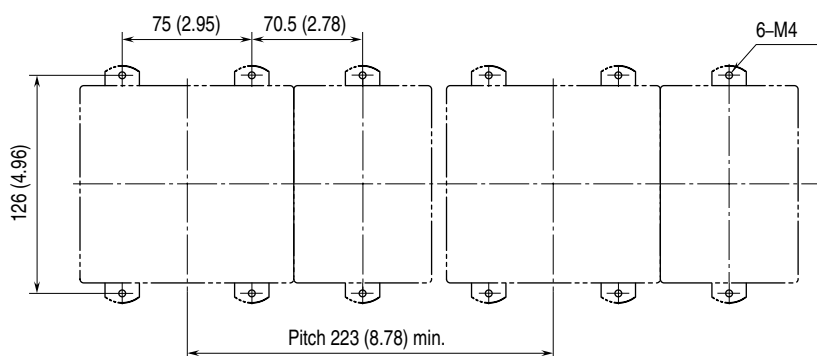

WIRING INSTRUCTIONS

■ SOLDERLESS TERMINAL

Refer to the drawing below for recommended ring tongue terminal size. Spade tongue type is also applicable.

• M3 Screw (LONWORKS and current input)

Applicable wire size: 0.25 to 1.65 mm² (AWG22 to 16)

Torque: 0.5 N·m

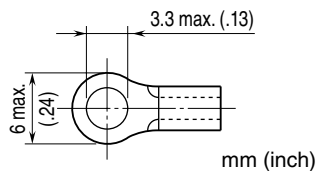

• M3.5 Screw (auxiliary power and voltage input)

Applicable wire size: 1.04 to 2.63 mm² (AWG16 to 14)

Torque: 0.8 N·m

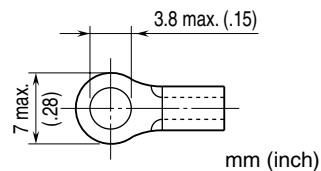

COMMUNICATION CABLE CONNECTIONS

■ MASTER CONNECTION

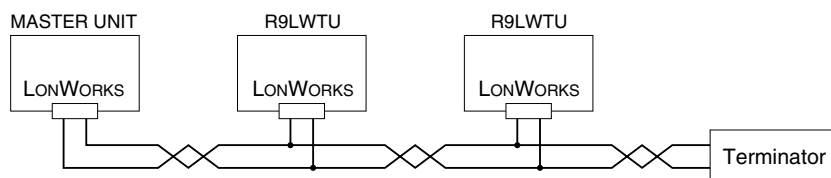

LonWorks COMMUNICATION

■ DEVICE INTERFACE FILE

Device Interface File (XIF) is used to define a LONWORKS device when programmed on LonMaker.

For this module, the following file is used:

R9LWTU2v100.XIF for R9LWTU-2000-AD4

R9LWTU2v110.XIF for R9LWTU-2001-AD4

The XIF files are downloadable at our web site.

■ OPERATING ENVIRONMENT

Software requirements	LonMaker 3.1 or later LNS Ver. 3.0 Service Pack 8 or later
-----------------------	---

■ TRANSMISSION SPECIFICATIONS

Transmission Mode	LonTalk																																																								
Interface	TP/FT-10 Neuron chip: FT3120 Transceiver: FT-X1 (equivalent to FTT-10A)																																																								
Transfer Rate	78 kbps																																																								
Program ID	<table border="0"> <tr> <td>9</td> <td>000DF</td> <td>1535</td> <td>0A</td> <td>04</td> <td>06</td> <td></td> <td>R9LWTU-2xxx-AD4</td> </tr> <tr> <td></td> <td></td> <td></td> <td></td> <td></td> <td></td> <td></td> <td>SPID Model Number</td> </tr> <tr> <td></td> <td></td> <td></td> <td></td> <td></td> <td></td> <td></td> <td>Media Channel – TP/FT-10</td> </tr> <tr> <td></td> <td></td> <td></td> <td></td> <td></td> <td></td> <td></td> <td>Usage Class – General</td> </tr> <tr> <td></td> <td></td> <td></td> <td></td> <td></td> <td></td> <td></td> <td>Device Class – Multi-Phase Power Monitor</td> </tr> <tr> <td></td> <td></td> <td></td> <td></td> <td></td> <td></td> <td></td> <td>Manufacturer ID – M-System Co., Ltd.</td> </tr> <tr> <td></td> <td></td> <td></td> <td></td> <td></td> <td></td> <td></td> <td>Standard Format</td> </tr> </table>	9	000DF	1535	0A	04	06		R9LWTU-2xxx-AD4								SPID Model Number								Media Channel – TP/FT-10								Usage Class – General								Device Class – Multi-Phase Power Monitor								Manufacturer ID – M-System Co., Ltd.								Standard Format
9	000DF	1535	0A	04	06		R9LWTU-2xxx-AD4																																																		
							SPID Model Number																																																		
							Media Channel – TP/FT-10																																																		
							Usage Class – General																																																		
							Device Class – Multi-Phase Power Monitor																																																		
							Manufacturer ID – M-System Co., Ltd.																																																		
							Standard Format																																																		
Address Table	15																																																								
Alias Table	127																																																								
Domain Table	2																																																								

■ FUNCTIONAL BLOCKS

The following five Functional Blocks are available.

OBJECT ID	FUNCTIONAL BLOCK
0	NodeObject
1	CommonObject
2 – 9	SystemObject 1 - 8
10 – 17	SystemObject 9 - 16 (Available when R9WTU-EP8 is connected)
18 – 25	CounterObject 1 - 8 (Available when R9WTU-ED16 is connected)
26 – 33	DOObject (Available when R9WTU-ED16 is connected)

■ SUPPORTED NETWORK VARIABLE TYPES

Supported Network Variable Types and their effective range, resolution are as follows:

TYPE	VARIABLE	EFFECTIVE RANGE	RESOLUTION
SNVT_amp_f	Current	0.000 – 20 000.000 A	0.001 A
SNVT_vol_f	Voltage	0.00 – 400 000.00 V	0.01 V
SNVT_power_f	Power	-2 000 000 000 – +2 000 000 000 (W or var)	1 (W or var)
SNVT_freq_f	AC frequency	0.00 or 45.00 – 65.00 Hz	0.01 Hz
SNVT_pwr_fact_f	Power factor	-1.0000 to +1.0000 cos φ	0.0001 cos φ
SNVT_elec_kwh_l	Energy	0.0 – 99 999 999.9 (kWh or kvarh) Reset to 0 when counted up to the maximum value.	0.1 (kWh or kvarh)
SNVT_count_f	Counter	0.0 – 9 999 999.0 Reset to 0 when counted up to the maximum value.	1.0

FUNCTIONAL BLOCKS

■ NodeObject FUNCTIONAL BLOCK

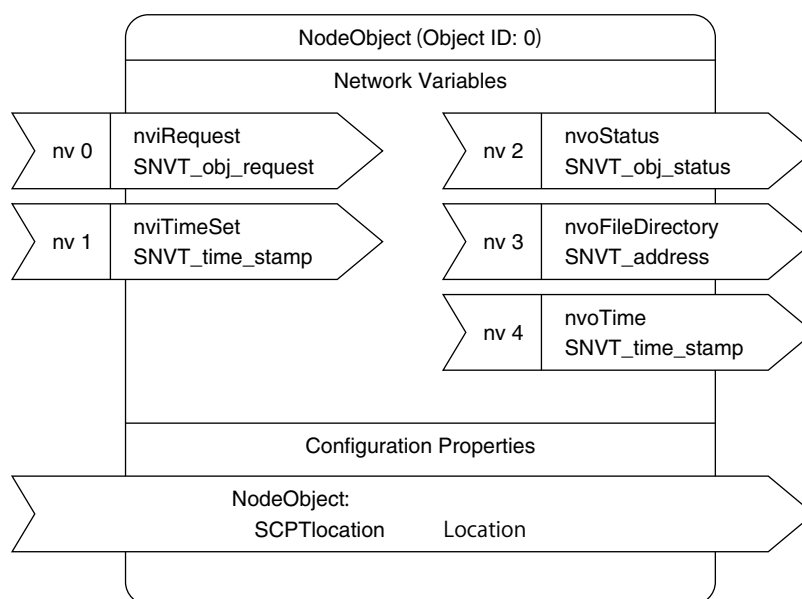

■ FUNCTIONAL BLOCK

• Network Variable

nv	NETWORK VARIABLE	TYPE	EXPLANATIONS	
0	nviRequest	SNVT_obj_request	A request is provided through Object ID (object_id) and Request (object_request) and its result is output through nvoStatus. Usable object_id and object_request are as follows:	
			object_id	0 : All objects 1 to 9 : Specify object ID of the Functional Block Other : Invalid ID
			object_request	RQ_NORMAL Used to return the 54UL to normal status. Disabled objects are enabled.
				RQ_ENABLE Used to enable disabled objects.
				RQ_DISABLE Used to disable a specified object. Disabled objects stop sending or resetting network variables.
				RQ_REPORT_MASK Used to set 1 at supported status values and output to nvoStatus.
				RQ_UPDATE_STATUS Used to obtain a specified object status. If all objects are specified, OR result of individual status values is set at nvoStatus.
				RQ_CLEAR_STATUS Used to clear error counter and others.
The following Requests are NOT supported. RQ_SELF_TEST RQ_OVERRIDE RQ_RMV_OVERRIDE RQ_UPDATE_ALARM RQ_CLEAR_ALARM RQ_CLEAR_RESET RQ_RESET				
1	nviTimeSet	SNVT_time_stamp	Date/time entered into the internal calendar is specified. The present date/time can be read by using nvoTime.	

nv	NETWORK VARIABLE	TYPE	EXPLANATIONS	
2	nvoStatus	SNVT_obj_status	The result of a request entered at nviRequest is output with Object ID and status value.	
			FIELD	EXPLANATIONS
			object_id	Object ID Bits following object_id show OR result of individual objects when 0 is set.
			invalid_id	Invalid Object ID
			invalid_request	Invalid Request
			disabled	Object is disabled. Disabled objects stop sending or resetting network variables.
			out_of_limits	The relevant bit reads 1 when voltage, current or AC frequency is out of the respective rated range. 0 is read otherwise.
			open_circuit	Not supported (always 0)
			out_of_service	Not supported (always 0)
			mechanical_fault	Not supported (always 0)
			feedback_failure	Not supported (always 0)
			over_range	Not supported (always 0)
			under_range	Not supported (always 0)
			electrical_fault	Not supported (always 0)
			unable_to_measure	1 is read when network variables are not updated due to certain function failure of the unit.
			comm_failure	Not supported (always 0)
			fail_self_test	Not supported (always 0)
			self_test_in_progress	Not supported (always 0)
			locked_out	Shows the unit is online but unable to operate normally. 1 is read at the bit when unable_to_measure bit turns to 1.
			manual_control	Not supported (always 0)
			in_alarm	Not supported (always 0)
in_override	Not supported (always 0)			
report_mask	Shows the response is for RQ_REPORT_MASK request. With the bit read 1, all other bits supported by the unit read 1 and unsupported ones read 0.			
programming_mode	Not supported (always 0)			
programming_fail	Not supported (always 0)			
alarm_notify_disabled	Not supported (always 0)			
reserved1	Reserved (always 0)			
reserved2	Reserved (always 0)			
3	nvoFileDirectory	SNVT_address	Used by integration tools.	
4	nvoTime	SNVT_time_stamp	Date/time of the internal calendar	

• Configuration Property

NETWORK VARIABLE	TYPE {Range} {Default}	EXPLANATIONS
SCPTlocation	SNVT_str_asc {ascii 31 characters} { “” }	Subsystem information required for use with network recovery tools. Max. 31 ASCII characters including terminating null character.

CommonObject FUNCTIONAL BLOCK

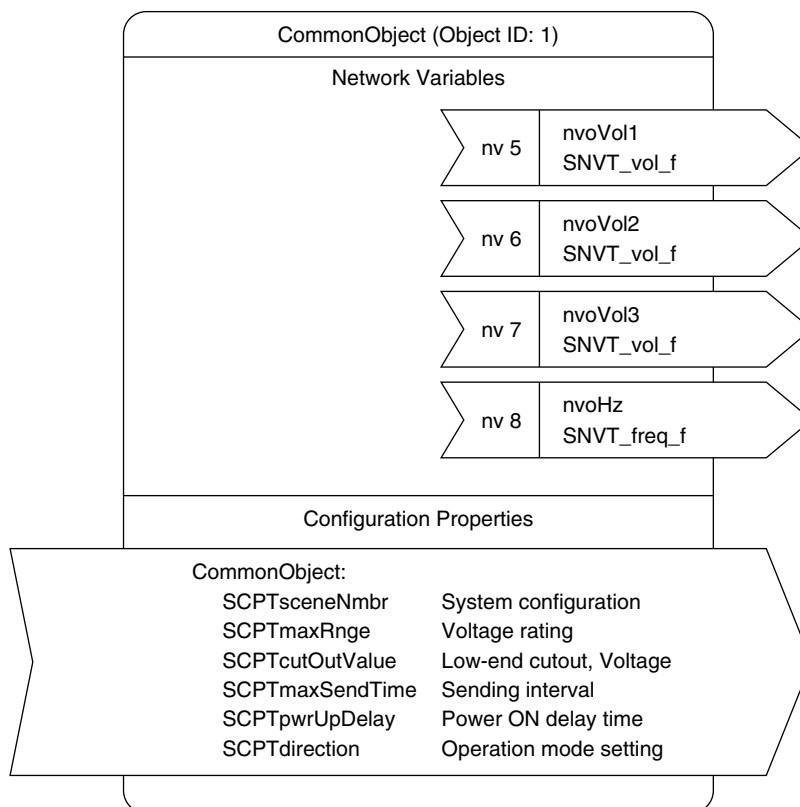

• Network Variable

nv	NETWORK VARIABLE	TYPE	EXPLANATIONS
5	nvoVol1	SNVT_vol_f	Voltage 1* ¹
6	nvoVol2	SNVT_vol_f	Voltage 2* ¹
7	nvoVol3	SNVT_vol_f	Voltage 3* ¹
8	nvoHz	SNVT_freq_f	Frequency

*1. Assignments depend upon system configuration.

Single-phase/2wire	Voltage 1: Phase 1	Voltage 2: 0	Voltage 3: 0
Single-phase/3-wire	Voltage 1: Phase 1	Voltage 2: Phase 3	Voltage 3: Delta 3 – 1
Three-phase/3-wire	Voltage 1: Delta 1 – 2	Voltage 2: Delta 2 – 3	Voltage 3: Delta 3 – 1

• Configuration Propety

NETWORK VARIABLE	TYPE { Range } { Default }	EXPLANATIONS
SCPTsceneNmbr	unsigned short { 0 - 3 } { 1 }	System configuration 0 : Single-phase / 2-wire 1 : Single-phase / 3-wire 2 : Three-phase / 3-wire, balanced load (1CT) 3 : Three-phase / 3-wire, unbalanced load (2CT)
SCPTmaxRnge	SNVT_vol_f { 50 - 400 000 } { 110 }	Voltage rating The numbers of the specified value after the decimal point are rounded down. When external voltage transformer is used, secondary voltage rating is fixed to 110 V. The specified value is regarded as primary voltage rating to calculate the voltage. In this case, the specified value can be set and utilized up to 400 kV. When SCPTdirection set the direct voltage input, the specified value is regarded as voltage rating to calculate the voltage. In this case, the specified value can be set and utilized up to 240 V.
SCPTcutOutValue	SNVT_temp_p { 0.0 to 99.9 } { 1.0 }	Low-end cutout, Voltage The voltage below (rated voltage x Specified value / 100) is disregarded and the data is set to 0 V.
SCPTmaxSendTime	SNVT_time_sec { 0.0 to 6553.4 } { 3.0 }	Sending time intervals of output network variables. The module does not send out network variables when 6553.4 (sec.) is set. Used for polling.
SCPTpwrUpDelay	SNVT_time_sec { 0.0 to 6553.4 } { 0.0 }	Delay time to start sending network variables after the power is turned on.
SCPTdirection	SNVT_state { 0 or 1 } { 0,0,0,0,0,0,0,0, 0,0,0,0,0,0,0 }	Bit 0: The network variable's sending pattern by each sending cycle is determined. See the figure below. 0 = All bound variables are sent. 1 = Bound variables are sent one by one. Bit 1: Set '1', when direct voltage input is used without external voltage transformer.

• SCPTdirection bit 0 = 0

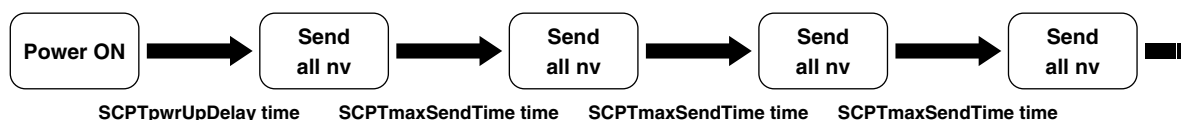

• SCPTdirection bit 0 = 1

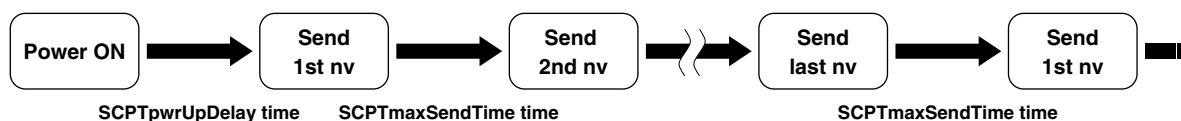

■ SystemObject 1 to 16 FUNCTIONAL BLOCK

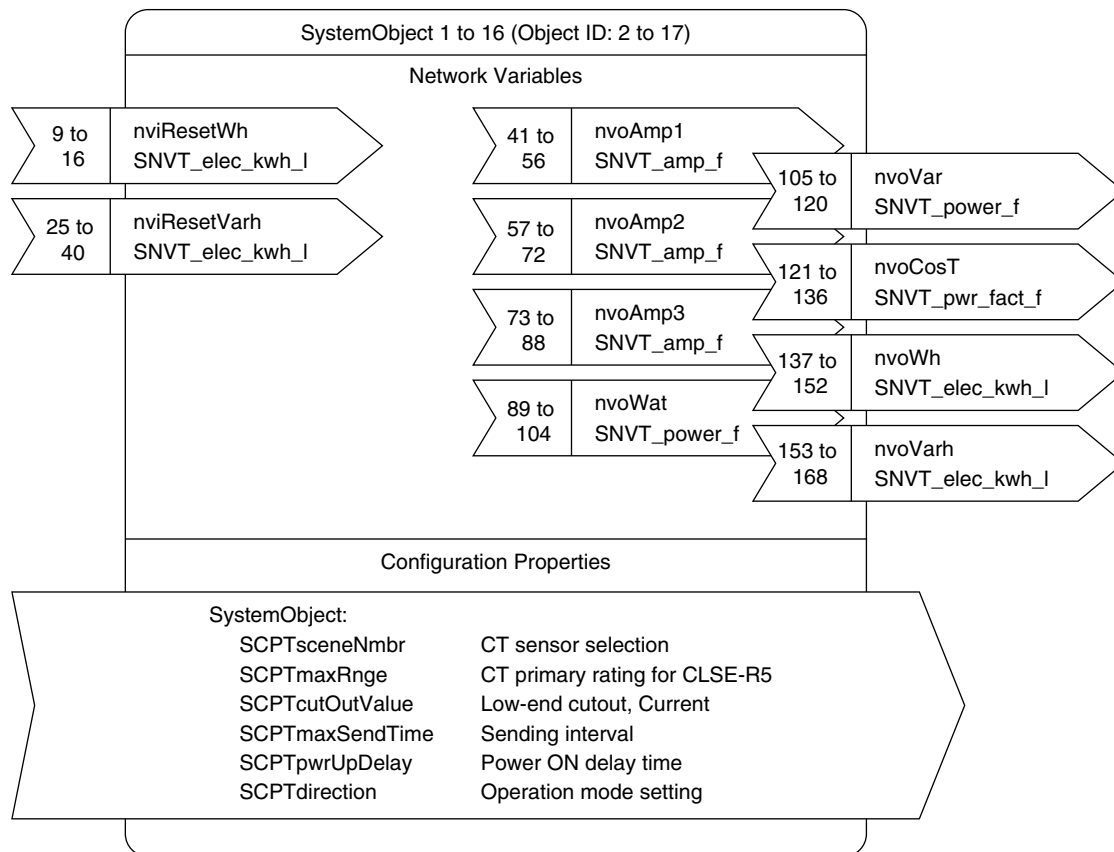

■ SystemObject FUNCTIONAL BLOCK

• Network Variable

nv	NETWORK VARIABLE	TYPE	EXPLANATIONS
9 – 24	nviResetWh	SNVT_elec_kwh_l	Active energy, preset 'nvoWh' is preset by specified value. 'nvoWh' is reset (clear to 0) when '0.0' is entered.
25 – 40	nviResetVarh	SNVT_elec_kwh_l	Reactive energy, preset 'nvoVarh' is preset by specified value. 'nvoVarh' is reset (clear to 0) when '0.0' is entered.
41 – 56	nvoAmp1	SNVT_amp_f	Current 1* ²
57 – 72	nvoAmp2	SNVT_amp_f	Current 2* ²
73 – 88	nvoAmp3	SNVT_amp_f	Current 3* ²
89 – 104	nvoWat	SNVT_power_f	Active power
105 – 120	nvoVar	SNVT_power_f	Reactive power
121 – 136	nvoCosT	SNVT_pwr_fact_f	Power factor
137 – 152	nvoWh	SNVT_elec_kwh_l	Active energy
153 – 168	nvoVarh	SNVT_elec_kwh_l	Reactive energy

*2. Assignments depend upon system configuration.

Single-phase/2-wire Current 1: Line 1 Current 2: 0 Current 3: 0

Single-phase/3-wire Current 1: Line 1 Current 2: Line 3 Current 3: Neutral

Three-phase/3-wire Current 1: Line 1 Current 2: Line 2 Current 3: Line 3

• Configuration Property

NETWORK VARIABLE	TYPE { Range } { Default }	EXPLANATIONS
SCPTsceneNمبر	unsigned short { 0 to 5 } { 0 }	CT sensor selection 0: CLSE-R5 (5A) 1: CLSE-05 (50A) 2: CLSE-10 (100A) 3: CLSE-20 (200A) 4: CLSE-40 (400A) 5: CLSE-60 (600A)
SCPTmaxRnge	SNVT_amp_f { 5 to 20 000 } { 5 }	Primary rating when CLSE-R5 is chosen for CT sensor The numbers of the specified value after the decimal point are rounded down. The current is calculated by primary rating of the sensor when the sensor other than CLSE-R5 is chosen.
SCPTcutOutValue	SNVT_temp_p { 0.0 to 99.9 } { 1.0 }	Low-end cutout, Current The current below (rated current x specified value / 100) is disregarded and the data is set to 0 V. The rated current is the value specified by SCPTmaxRnge when CLSE-R5 is chosen for CT sensor. The rated current is primary rating of the sensor when the sensor other than CLSE-R5 is chosen.
SCPTmaxSendTime	SNVT_time_sec	Shared use with SCPTmaxSendTime of Common Object
SCPTpwrUpDelay	SNVT_time_sec	Shared use with SCPTpwrUpDelay of Common Object
SCPTdirection	SNVT_state	Shared use with SCPTdirection of Common Object

CounterObject 1 to 8 FUNCTIONAL BLOCK

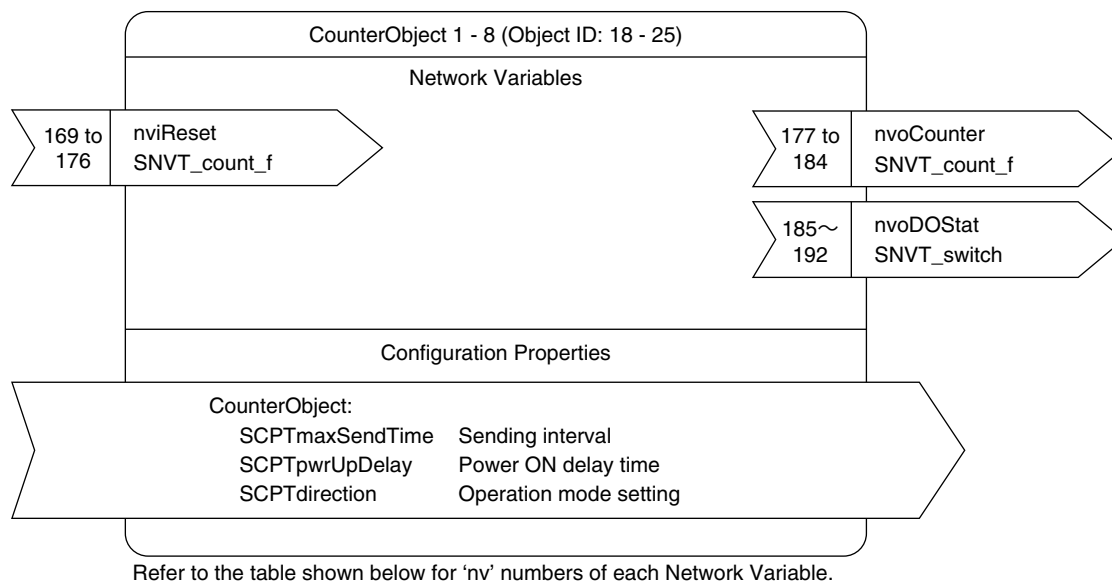

CounterObject FUNCTIONAL BLOCK

• Network Variable

nv	NETWORK VARIABLE	TYPE	EXPLANATIONS
169 – 176	nvReset	SNVT_count_f	Counter, preset 'nvoCounter' is preset by specified value. 'nvoCounter' is reset (clear to 0) when '0.0' is entered.
177 – 184	nvoCounter	SNVT_count_f	Counter data
185 – 192	nvoDOStat	SNVT_switch	Status of the contact { 0.0 0 } : OFF { 100.0 1 } : ON

• Configuration Property

NETWORK VARIABLE	TYPE	EXPLANATIONS
SCPTmaxSendTime	SNVT_time_sec	Shared use with SCPTmaxSendTime of Common Object
SCPTpwrUpDelay	SNVT_time_sec	Shared use with SCPTpwrUpDelay of Common Object
SCPTdirection	SNVT_state	Shared use with SCPTdirection of Common Object

Note: Counter does not function correctly without R9WTU-ED16 connected.

■ DOObject 1 to 8 FUNCTIONAL BLOCK

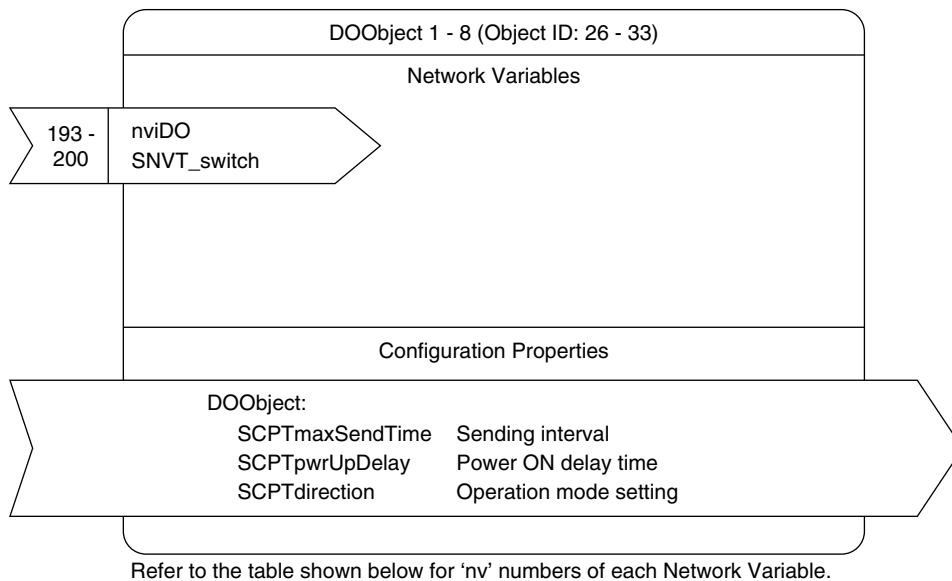

■ DOObject FUNCTIONAL BLOCK

• Network Variable

nv	NETWORK VARIABLE	TYPE	EXPLANATIONS
193 - 200	nviDO	SNVT_switch	Status of the contact output {0.0 0} : OFF {100.0 1} : ON

• Configuration Property

NETWORK VARIABLE	TYPE	EXPLANATIONS
SCPTmaxSendTime	SNVT_time_sec	Shared use with SCPTmaxSendTime of Common Object
SCTpwrUpDelay	SNVT_time_sec	Shared use with SCPTpwrUpDelay of Common Object
SCPTdirection	SNVT_state	Shared use with SCPTdirection of Common Object

Note: 'nviDO' does not function correctly without R9WTU-ED16 connected.

DATA LOGGING IN SD CARD

■ GENERAL DESCRIPTION

The R9LWTU is equipped with a SD card slot. The unit transfers to the card at 0 minute every hour its internal memory data: energy per hour; and voltage, current, power and energy per minute. A 4-GB SD card can store information of 8 channels for approx. 16 years.

■ TIMING

Data recording is started from 0 minute of the hour when the card is inserted.

For example, if it is inserted at 9:50, data from 9:00 to 10:00 is transferred to the card at 10:00, and later data is added every hour until the card is extracted. (If the unit has been started later than 9:00, data before the startup is not available.)

If the card is not in the unit on the hour, data transfer is not executed and the internal data is automatically erased until one is inserted to the unit again.

The SDCard LED starts blinking 30 seconds before the hour every hour for noticing start of writing operation.

DO NOT extract the card while the LED is blinking until the writing is complete.

If the card is extracted or the power supply to the unit is turned off while it is writing, stored data may be destroyed and inaccessible.

■ SD CARD

Prepare one of the following types of memory card:

- Manufacturer: Hagiwara Solutions
Model: NSD6-004GH(A00SDI (discontinued),
NSDA-004GT (discontinued),
NSDA-004GL (discontinued),
NSD6-004GH(B21SEI
- Manufacturer: Apacer Technology
Model: AP-ISD04GIS4B-T, AP-ISD04GIS4B-3T

WE ARE NOT LIABLE FOR ANY LOSS OF DATA.

Data may be lost in but not limited to the following cases:

- Wrong handling of the card
- Static or electric noise interference
- When the card is extracted or when the power supply to the unit is turned off while it is accessed.
- When formatting SD card, use a dedicated software "SD Card Formatter".
"SD Card Formatter" is downloadable at SD Association's web site.
<https://www.sdcard.org>

■ CALENDAR

The incorporated calendar IC is backed up with a battery which enables the calendar backup for 2 years with no external power supply.

We recommend that the power supply is maintained as long as possible while the SD card is used.

The battery does not wear while the external power is supplied, however, the calendar cannot be backed up after the total elapsed time without power supply exceeds 2 years.

The unit indicates a calendar error with POWER LED, and resets the date and time to Year 2000, January 1, 00:00:00. Refer to "COMPONENT IDENTIFICATION" section. Set the date and time again in such a case.

Once the backup battery life is expired, the unit indicates the same error every time the power supply to it is turned on.

■ DIRECTORY

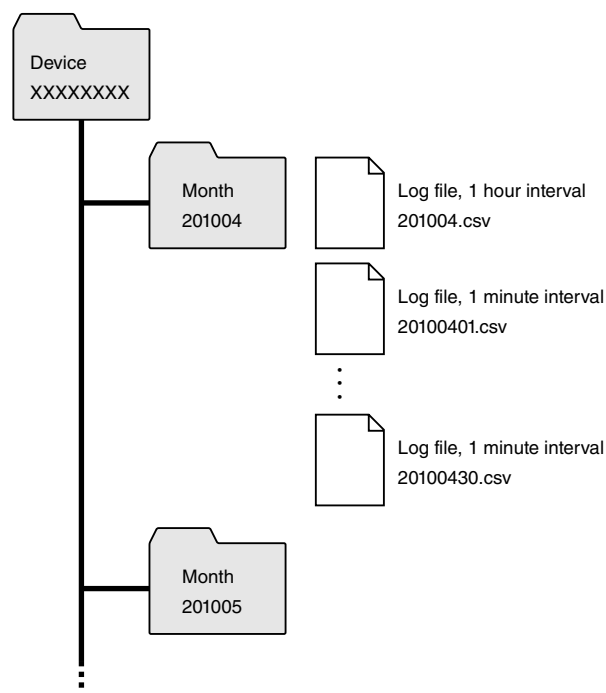

• Device Folder

A data folder inherent to the device is automatically created, and monthly folders are created in it.

Device folder is identified with the device's serial number (8 characters).

• Monthly Folder

Monthly folders are identified with year (4 characters) and month (2 characters). All log files for the designated month are stored in it.

• Log File, 1 Hour Interval

Energy (watthour) and pulse counts per hour for each channel is stored on the hour every hour.

Each data storage cycle takes 1 row, and at the maximum of 1 month data is stored in a CSV (divided with comma) format file. The first row of the file contains the data contents descriptions and the second contains the engineering unit descriptions.

PARAMETER	DATE	TIME	Ch. 1 Energy	Ch. 2 Energy		Ch. 8 Energy* ¹	DI 1 Pulse Count* ²	DI 2 Pulse Count* ²		DI 8 Pulse Count* ²
Row 1 Comment	Date	Time	1ch-EP	2ch-EP		8ch-EP	DI1-count	DI2-count		DI8-count
Row 2 Unit			kWh	kWh	kWh	pulse	pulse	pulse
Example	2010/08/25	10:00	123.4	123.4		123.4	4567	4567		4567
	2010/08/25	11:00	123.4	123.4		123.4	4567	4567		4567

• Log File, 1 Minute Interval

Voltage, current, power, energy (watthour), and pulse counts per minute for each channel is stored.

Data transfer for the whole hour to the SD card is executed only at the same moment as for the hourly data.

Each data storage cycle takes 1 row, and at the maximum of 1 day data is stored in a CSV (divided with comma) format file.

The first row of the file contains the data contents descriptions and the second contains the engineering unit descriptions.

PARAMETER	DATE	TIME	Voltage 1	Voltage 2	Voltage 3	Ch.1 Current 1	Ch. 1 Current 2	Ch. 1 Current 3	Ch. 2 Current 1		Ch. 8 Current 3* ¹	Ch. 1 Power	Ch. 2 Power		Ch. 8 Power* ¹	Ch. 1 Energy	Ch. 2 Energy		Ch. 8 Energy* ¹	DI 1 Pulse Count* ²	DI 2 Pulse Count* ²		DI 8 Pulse Count* ²
Row 1 Comment	Date	Time	U1	U2	U3	1ch-I1	1ch-I2	1ch-I3	2ch-I1		8ch-I3	1ch-P	2ch-P		8ch-P	1ch-EP	2ch-EP		8ch-EP	DI1-count	DI2-count		DI8-count
Row 2 Unit			V	V	V	A	A	A	A	kWh	kW	kW	kWh	kWh	kWh	kWh	pulse	pulse	pulse
Example	2010/08/25	10:00	110.00	110.00	110.00	5.000	5.000	5.000	5.000		5.000	1.650	1.650		1.650	12.3	12.3		12.3	456	456		456
	2010/08/25	10:01	110.00	110.00	110.00	5.000	5.000	5.000	5.000		1.650	1.650	1.650		1.650	12.3	12.3		12.3	456	456		456

*1. Up to 16 channels with the R9WTU-EP8

*2. DI pulse counts are recorded only with the R9WTU-ED16

Voltage and current data are assigned as in the following table.

Three-phase / 3-wire	Voltage 1	Delta voltage, 1 – 2	Single-phase / 3-wire	Voltage 1	Phase voltage, Phase 1	Single-phase / 2-wire	Voltage 1	Phase voltage, Phase 1
	Voltage 2	Delta voltage, 2 – 3		Voltage 2	Phase voltage, Phase 3		Voltage 2	0
	Voltage 3	Delta voltage, 3 – 1		Voltage 3	Delta voltage, 3 – 1		Voltage 3	0
	Current 1	Current, Line 1		Current 1	Current, Line 1		Current 1	Current, Line 1
	Current 2	Current, Line 2		Current 2	Current, Line 3		Current 2	0
	Current 3	Current, Line 3		Current 3	Neutral current		Current 3	0

LIGHTNING SURGE PROTECTION

We offer a series of lightning surge protector for protection against induced lightning surges. Please contact us to choose appropriate models.