

## Rack-mounted DCS Signal Conditioners 18K-RACK

### CURRENT LOOP SUPPLY

(applicable to HART signal, opencircuit detection selectable)

#### Functions & Features

- Powers a 4 - 20 mA DC current loop
- Isolates and relays HART signals
- Shortcircuit protection
- Opencircuit detection selectable
- Module can be retracted without removing wiring for an insulation test

#### Typical Applications

- 2-wire HART transmitters

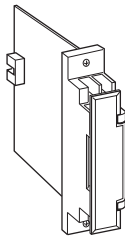

## MODEL: 18KDYH2-A[1]-R[2]

### ORDERING INFORMATION

- Code number: 18KDYH2-A[1]-R[2]
- Specify a code from below for each of [1] and [2].  
(e.g. 18KDYH2-A6A-R/B/RE)

### INPUT

Current

A: 4 - 20 mA DC (Input resistance approx. 250Ω)

### [1] OUTPUT 1 / OUTPUT 2

6A: 1 - 5 V DC (Load resistance 2000 Ω min.)

/ 4 - 20 mA DC (Applicable to HART signal, load resistance 600 Ω max.)\*

A6: 4 - 20 mA DC (Applicable to HART signal, load resistance 600 Ω max.)\*

/ 1 - 5 V DC (Load resistance 2000 Ω min.)

AA: 4 - 20 mA DC (Applicable to HART signal, load resistance 600 Ω max.)\*

/ 4 - 20 mA DC (Load resistance 500 Ω max.)

\* 250 Ω ±10% for HART communication

### POWER INPUT

DC Power

R: 24 V DC

(Operational voltage range 24 V ±10 %, ripple 10 %p-p max.)

### [2] OPTIONS (multiple selections)

Opencircuit detection

blank: none

/B: Opencircuit detector (Only for HART signal)

Connector output polarity reversal

blank: none

/RE: Connector output polarity reversal (Only for HART signal)

### GENERAL SPECIFICATIONS

**Construction:** Rack-mounted; terminal access via screw terminals on the front and connector on the rear; terminal cover provided

#### Connection

**Input:** M3.5 screw terminals (torque 0.8 N·m) and connector

**Output 1:** Connector

**Output 2:** M3.5 screw terminals (torque 0.8 N·m) and connector

**Power input:** Supplied from connector

**Screw terminal:** Nickel-plated steel

**Isolation:** Input to output 1 to output 2 to power

**Overrange output:** Approx. -10 to +110 %

**Zero adjustment:** -5 to +5 % (front)

**Span adjustment:** 95 to 105 % (front)

**Open-circuit detection:** This function enables the input device to detect open circuit of output circuit isolated from the input circuit.

Input current 0 mA when the output loop is open.

Photo MOSFET Relay ON Resistance; 3 Ω max.

### SUPPLY OUTPUT

(across the terminals 1 - 2)

**Output voltage:** 24 - 28 V DC with no load

18 V DC at 20 mA

**Current rating:** ≤ 22 mA DC

• **Shortcircuit Protection**

**Current limited:** 30 mA max.

**Protected time duration:** No limit

### INPUT SPECIFICATIONS

■ **DC Current:** Input resistor incorporated

**Input current:** ≥ 0 mA

### OUTPUT SPECIFICATIONS

The output goes below 0 % when the input is open.

Polarity of connector output is reversed with option code

/RE (with connector output polarity reversal).

## ■ Blank (note)

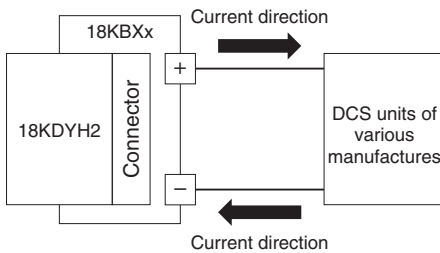

## ■ /RE (with connector output polarity reversal)

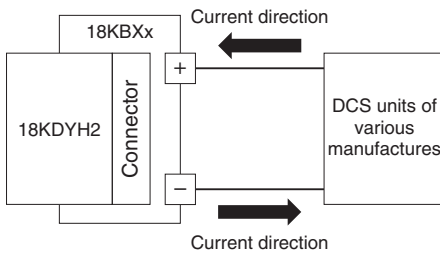

## HART COMMUNICATION

**Transmission gain:** Approx. -3 dB (within 1 - 3 kHz)  
measured with 250  $\Omega$  at output

**Loop impedance:** 250  $\Omega$   $\pm$ 10 %

**Communication directions:** Bidirectional

## INSTALLATION

**Current consumption:**

**Output Code 6A, A6:** Approx. 120 mA

**Output Code AA:** Approx. 130 mA

**Operating temperature:** -5 to +55°C (23 to 131°F)

**Operating humidity:** 30 to 90 %RH (non-condensing)

**Mounting:** Standard Rack 18KBXx

**Weight:** 110 g (0.24 lb)

## PERFORMANCE in percentage of span

**Accuracy:**  $\pm$ 0.1 %

**Temp. coefficient:**  $\pm$ 0.015 %/°C ( $\pm$ 0.008 %/°F)

**Response time:**  $\leq$  0.5 sec. (0 - 90 %)

**Line voltage effect**

**Supply output:**  $\pm$ 3 % over voltage range

**Output signal:**  $\pm$ 0.1 % over voltage range

**Insulation resistance:**  $\geq$  100 M $\Omega$  with 500 V DC

**Dielectric strength:** 500 V AC @ 1 minute (input to output 1 to output 2 to power to ground)

## EXTERNAL DIMENSIONS unit: mm [inch]

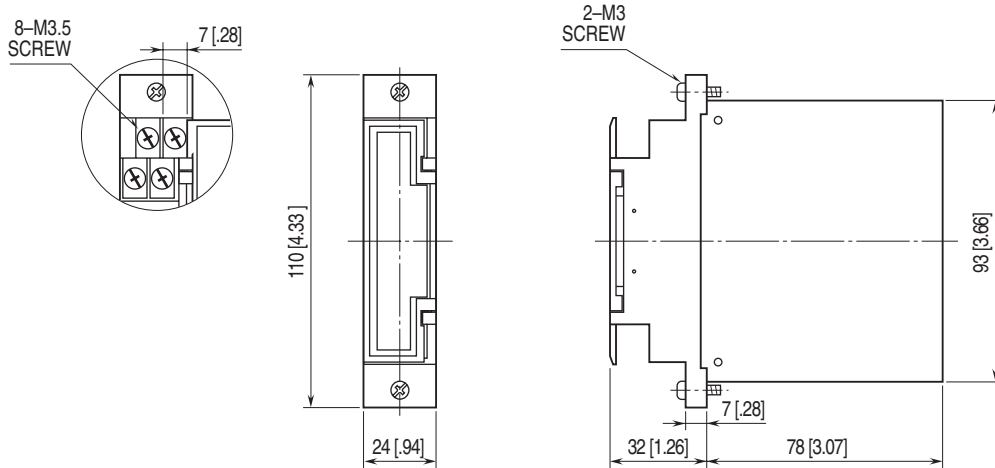

## TERMINAL ASSIGNMENTS

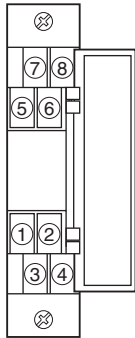

## SCHEMATIC CIRCUITRY & CONNECTION DIAGRAM

■ OUTPUT CODE: 6A

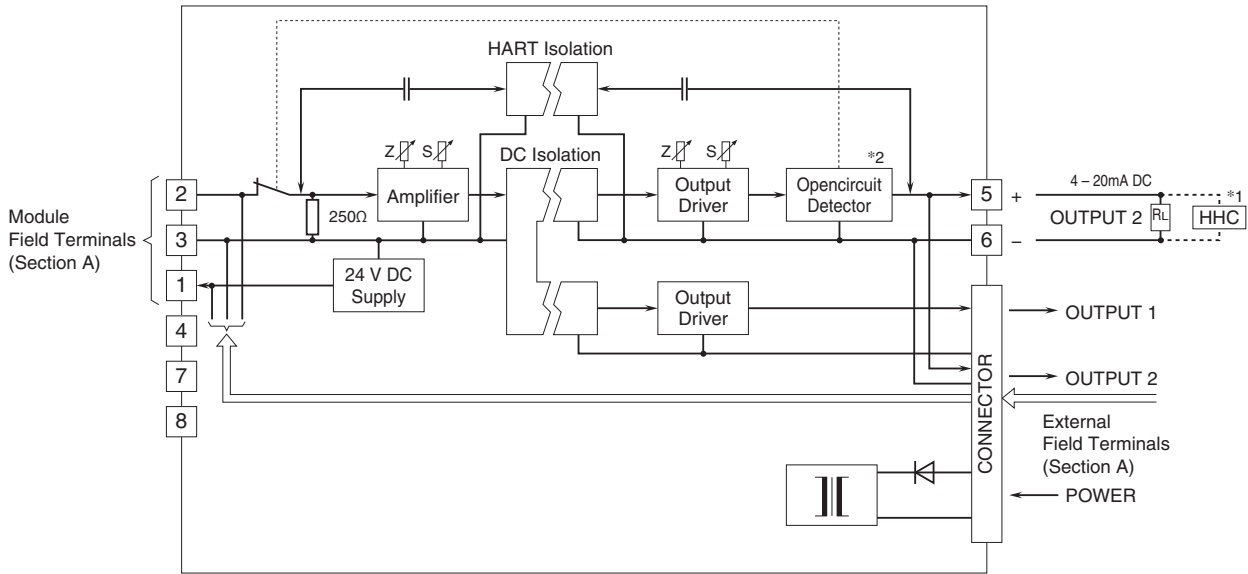

Note 1: Use either of module or external field terminals.

Note 2: For OUTPUT 2, use either of terminals on the front or connector on the rear.

\*1. Hand-held communicator

\*2. Included with option /B

### Section A. Field Terminals

■ When used as DC Supply

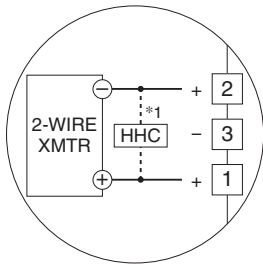

■ When used as Isolator

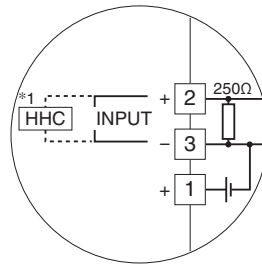

■ OUTPUT CODE: A6, AA

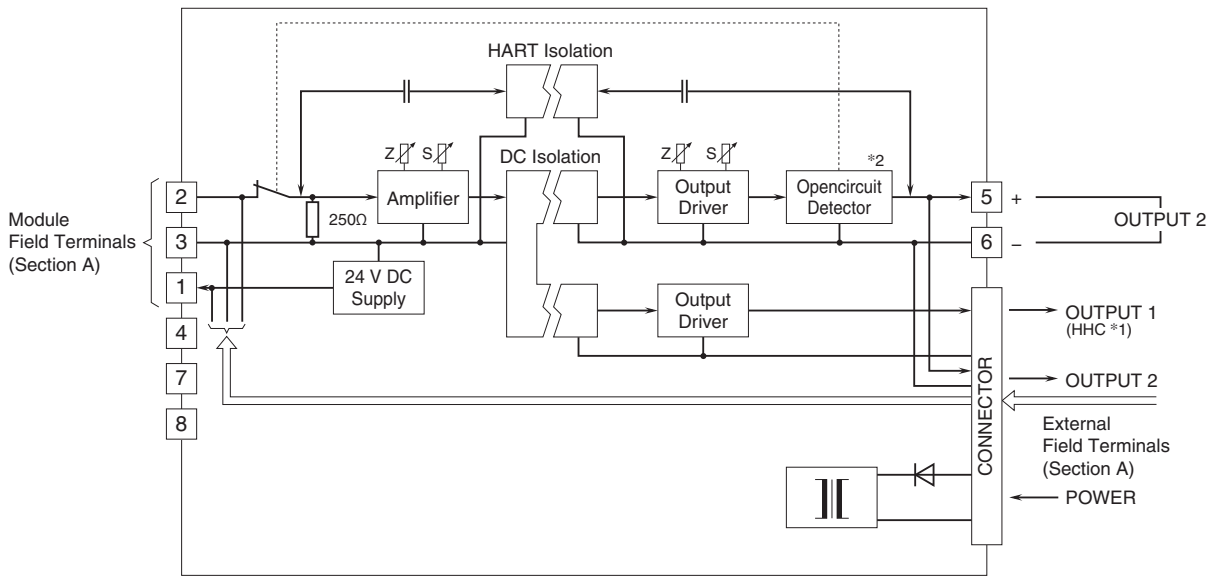

Note 1: Use either of module or external field terminals.

Note 2: For OUTPUT 2, use either of terminals on the front or connector on the rear.

\*1. Hand-held communicator

\*2. Included with option /B

**Section A. Field Terminals**

■ When used as DC Supply

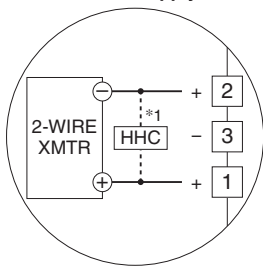

■ When used as Isolator

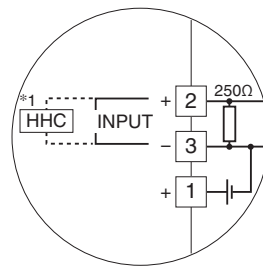

Specifications are subject to change without notice.