

## Digital Panel Meters 40 Series

### AC CURRENT INPUT DIGITAL PANEL METER

(4 digit, process meter, true RMS sensing)

#### Functions & Features

- 4 digit ( $\pm 9999$ ) panel meter
- Scaling and HOLD functions
- High visible, 0.8" (20.3mm) high and bright LED

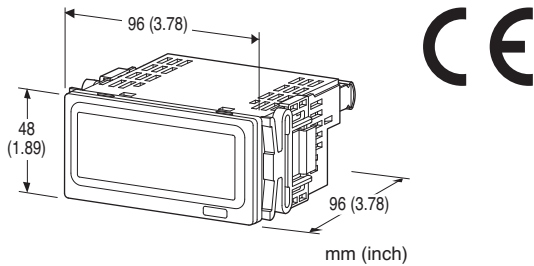

### MODEL: 40DCT-[1]-[2][3]

#### ORDERING INFORMATION

- Code number: 40DCT-[1]-[2][3]
- Specify a code from below for each of [1] through [3].  
(e.g. 40DCT-A5-K3/Q)
- Specify the specification for option code /Q  
(e.g. /C01/SET)

#### [1] INPUT

Current

- A1:** 0.00 - 20.00 mA AC (Conformance range)  
(Input range: 0.00 - 24.00 mA AC, Input resistance: 5  $\Omega$ )
- A2:** 0.0 - 200.0 mA AC (Conformance range)  
(Input range: 0.0 - 240.0 mA AC, Input resistance: 0.5  $\Omega$ )
- A3:** 0.000 - 2.000 A AC (Conformance range)  
(Input range: 0.000 - 2.400 A AC, Input resistance: 0.05  $\Omega$ )
- A4:** 0.000 - 1.000 A AC (Conformance range)  
(Input range: 0.000 - 1.200 A AC, Input transformer burden: 0.1 VA)
- A5:** 0.000 - 5.000 A AC (Conformance range)  
(Input range: 0.000 - 6.000 A AC, Input transformer burden: 0.5 VA)

#### [2] POWER INPUT

AC Power

- K3:** 100 - 120V AC  
(Operational voltage range 85 - 132 V, 47 - 66 Hz)
- L3:** 200 - 240V AC  
(Operational voltage range 170 - 264 V, 47 - 66 Hz)
- DC Power
- R:** 24 V DC  
(Operational voltage range 24 V  $\pm 20$  %, ripple 10 %p-p max.)

#### [3] OPTIONS

- blank: none
- /Q: With options (specify the specification)

#### SPECIFICATIONS OF OPTION: Q (multiple selections)

- COATING (For the detail, refer to our web site.)  
Moving parts and indicators are not coated.
- /C01: Silicone coating
- /C02: Polyurethane coating
- /C03: Rubber coating
- EX-FACTORY SETTING
- /SET: Preset according to the Ordering Information Sheet  
(No. ESU-9538)

#### GENERAL SPECIFICATIONS

- Construction:** Panel flush mounting
- Connection:** M3 screw terminals (torque 0.6 N·m)
- Solderless terminal:** Refer to the drawing at the end of the section.
- Recommended manufacturer:** Japan Solderless Terminal MFG.Co.Ltd, Nichifu Co.,Ltd
- Applicable wire size:** 0.25 to 1.65 mm<sup>2</sup> (AWG 22 to 16)
- Screw terminal:** Nickel-plated steel
- Housing material:** Flame-resistant resin (gray)
- Isolation:** Input to power
- Input waveform**
- RMS sensing:** Up to 15 % of 3rd harmonic content
- Sampling rate:** 10 times/sec. (100 msec.)
- Averaging:** None or moving average
- Setting:** (Front button)
  - Scaled range
  - Low-end cutout
  - Moving average
  - Brightness
  - Others

#### Recommended solderless terminal

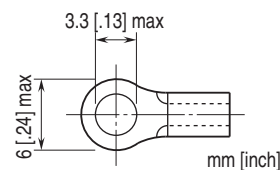

#### DISPLAY

- Display:** 4 digits of 20.3 mm (0.8 inch) height, 7-segment, red LED
- Display range:** -9999 to 9999
- Scaling range:** -9999 to 9999 counts
- Decimal point position:** 10<sup>-1</sup>, 10<sup>-2</sup>, 10<sup>-3</sup> or none
- Zero indication:** Higher-digit zeros are suppressed.
- Over-range indication:** '-9999' or '9999' blinking for display

values out of the display range. 'S.ERR' blinks surpassing the permissible range. 'ERR' blinks when input scaling setting is inappropriate.

**Engineering unit indication:** Sticker label attached

DC, AC, mV, V, kV,  $\mu$ A, mA, A, kA, mW, W, kW, var, kvar, Mvar, VA, Hz,  $\Omega$ , k $\Omega$ , M $\Omega$ , cm, mm, m, m/sec, mm/min, cm/min, m/min, m/h,  $m/s^2$ , inch,  $l$ ,  $l/s$ ,  $l/min$ ,  $l/h$ ,  $m^3$ ,  $m^3/sec$ ,  $m^3/min$ ,  $m^3/h$ ,  $Nm^3/h$ , N·m,  $N/m^2$ , g, kg, kg/h, N, kN, Pa, kPa, MPa, t, t/h,  $^{\circ}C$ ,  $^{\circ}F$ , %RH, J, kJ, MJ, rpm, sec, min, pH, %, ppm, etc.

## INPUT SPECIFICATIONS

### ■ AC Input

**Frequency:** 40 - 100 Hz; 45 - 65 Hz for input code A4 and A5

**Overload capacity:** 500 % of rating for 3 sec., 200 % for 10 sec., 120 % continuous

### Input burden:

A1: 0.002 VA

A2: 0.02 VA

A3: 0.2 VA

A4: 0.1 VA

A5: 0.5 VA

### ■ Hold Input: Dry contact input

**Detecting level:**  $\leq 1.5$  V

**Sensing:** Approx. 5 V DC, 1 mA

## INSTALLATION

### Power consumption

#### •AC:

$\leq 3.0$  VA for 100 - 120 V

$\leq 4.2$  VA for 200 - 240 V

#### •DC: $\leq 1.0$ W

**Operating temperature:** -10 to +55 $^{\circ}C$  (14 to 131 $^{\circ}F$ )

**Operating humidity:** 30 to 90 %RH (non-condensing)

**Mounting:** Panel flush mounting

**Weight:** 180 g (0.40 lb)

## PERFORMANCE

### Input accuracy:

A1 to A3:  $\pm 0.4\%$  rdg  $\pm 1$ digit,

(< 35 % of full scale:  $\pm 0.4\%$  FS  $\pm 1$ digit)

A4 to A5:  $\pm 0.4\%$  FS  $\pm 1$ digit

**Temp. coefficient:**  $\pm 0.015$  %/ $^{\circ}C$  ( $\pm 0.008$  %/ $^{\circ}F$ )

**Line voltage effect:**  $\pm 0.2$  % over voltage range

**Insulation resistance:**  $\geq 100$  M $\Omega$  with 500 V DC

**Dielectric strength:** 2000 V AC @ 1 minute

(input to power to ground)

## STANDARDS & APPROVALS

### EU conformity:

EMC Directive

EMI EN 61000-6-4

EMS EN 61000-6-2

Low Voltage Directive

EN 61010-1

Measurement Category I (input)

Installation Category II (power)

Pollution degree 2

Input to power: Reinforced insulation (300 V)

RoHS Directive

## DISPLAY HOLD COMMAND

Displayed value is held with an external HOLD command input. Connect the contacts across HOLD to COM. (Isolate with photo-coupler or relay as terminals 3 and 4 are not isolated to input signal, terminals 1 and 2.)

(a) Photo-Coupler

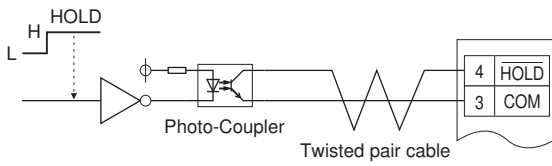

(b) Relay

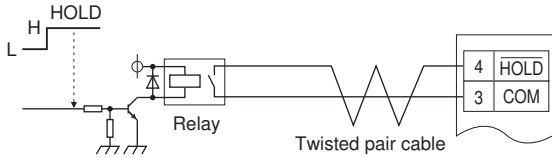

## EXTERNAL VIEW

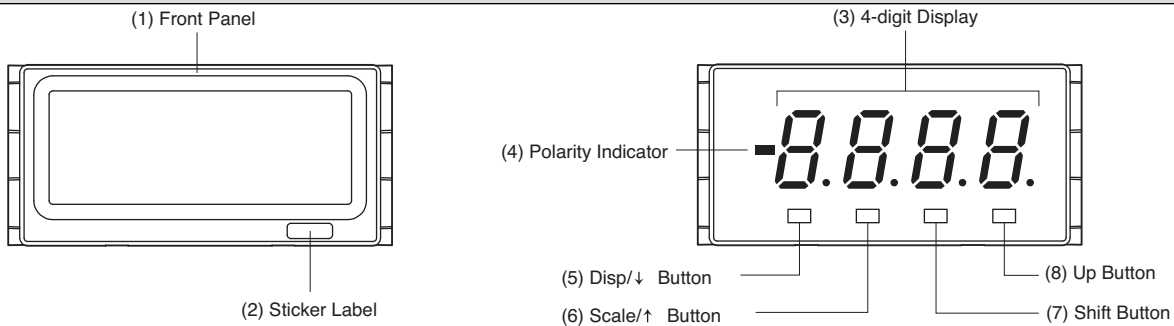

### FUNCTION TABLE

No.	COMPONENT	FUNCTIONS
(1)	Front panel	Removed at configuration.
(2)	Sticker label	Engineering unit label position
(3)	4-digit display	4-digit LED display. Range: 0 to 9999 (not including decimal point)
(4)	Polarity indicator	Turns on when negative value is displayed.
(5)	Disp/ ↓ button	Used to move on to the display setting modes, to shift through setting items in each setting mode, or shift through display digits in each setting item.
(6)	Scale/ ↑ button	Used to move on to the scaling setting modes, to shift through setting items in each setting mode, or shift through display digits in each setting item.
(7)	Shift button	Used to move on to the setting standby status.
(8)	Up button	Used to select setting value.

## PARAMETER LIST

### ■ SCALING SETTING MODE

PARAMETER	ITEM DISPLAY	DISPLAY	FUNCTION	INPUT CODE	DEFAULT VALUE
Decimal Point Position	<i>d Pt</i>	4th LSD – 2nd LSD, none	Decimal point position	A1	8888
				A2	8888
				A3	8888
				A4	8888
				A5	8888
Input Scaling Value A	<i>i Sr</i>	0000 – 2000 (0000 – 1000)*1 (0000 – 5000)*2	Input value to be set as Zero in the measurement range	A1	0000
				A2	0000
				A3	0000
				A4	0000
				A5	0000
Input Scaling Value B	<i>i Sp</i>	0000 – 2000 (0000 – 1000)*1 (0000 – 5000)*2	Input value to be set as Full Scale in the measurement range	A1	2000
				A2	2000
				A3	2000
				A4	1000
				A5	5000
Display Scaling Value A	<i>d Sr</i>	-9999 – 9999	Display value for input scaling value A	A1	0000
				A2	0000
				A3	0000
				A4	0000
				A5	0000
Display Scaling Value B	<i>d Sp</i>	-9999 – 9999	Display value for input scaling value B	A1	2000
				A2	2000
				A3	2000
				A4	1000
				A5	5000
Low-end cutout *3	<i>Li nt</i>	OFF	Low-end cutout OFF	-	OFF
		ON	Low-end cutout ON		
		ABS	Absolute value low-end cutout ON		
Low-end cutout value *3	<i>Li nn</i>	000 – 999	Low-end cutout value setting	-	000

\*1. For input code 'A4'

\*2. For input code 'A5'

\*3. Input signal less than the preset cutout value is forcibly cut to display scaling value "zero".

Use when minus value is not required. Lower 3 digits of displayed value are set regardless of decimal point position.

Note: With the low-end cutout or absolute value low-end cutout set to ON, the low-end cutout value setting is valid.

## • Input scaling

Zero and full scale of input range can be re-configured to user's desired value by entering parameters.  
When initialization of setting is executed, these data is lost and return to the default value.

Input Scaling Value A: Input value for zero point  
(Input scaling value A < Input scaling value B)  
Enter the value you want to set to zero in the measurement range.  
Input Scaling Value B: Input value for full scale point  
Enter the value you want to set to full scale in the measurement range.

## • Display scaling

Display Scaling Value A: Display value for Input Scaling Value A  
Display Scaling Value B: Display value for Input Scaling Value B

## • Normal Scaling

The display value increases when the input signal increases.

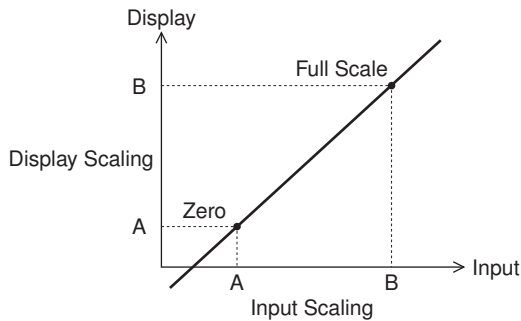

## • Inverted Scaling

The display value decreases when the input signal increases.

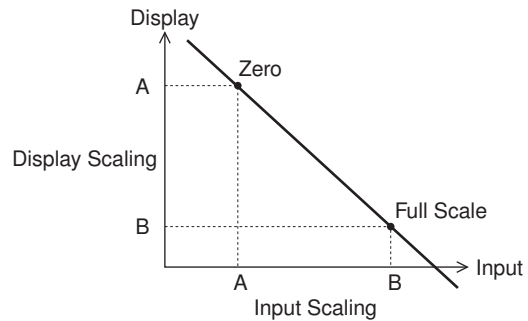

Decimal point position: Decimal point position is specified independently from the scaling. When you set the display scaling, include zeros for fractions.

## ■ DISPLAY SETTING MODE

PARAMETER	ITEM DISPLAY	DISPLAY	FUNCTION	DEFAULT VALUE
Moving Average	Ave	OFF	No moving averaging	OFF
		A 2	Moving average with 2 samples	
		A 4	Moving average with 4 samples	
		A 8	Moving average with 8 samples	
		A 16	Moving average with 16 samples	
Brightness	brt	[ 0	Brightness level 0 (dark)	[ 5
		[ 1	Brightness level 1	
		[ 2	Brightness level 2	
		[ 3	Brightness level 3	
		[ 4	Brightness level 4	
		[ 5	Brightness level 5 (bright)	
Initialization	rst	OFF	Non-initialization	OFF
		on	Initialize settings (change to factory settings) *1	
Version Indication	-	-	Version number, indication only	-

\*1. While "on" is shown, pressing Shift button initializes settings.

When initialization of setting is executed, existing each parameter settings are lost and return to default value.  
Be aware that settings does not return to the ex-factory settings specified by /SET option.

## EXTERNAL DIMENSIONS & TERMINAL ASSIGNMENTS unit: mm [inch]

### TOP VIEW

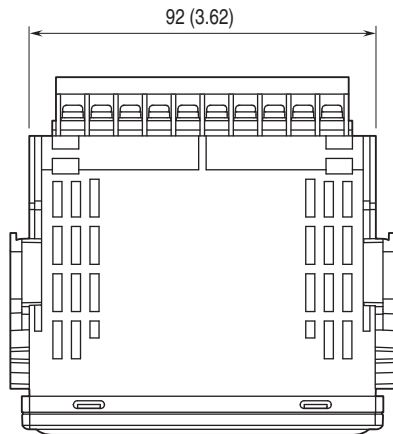

### FRONT VIEW

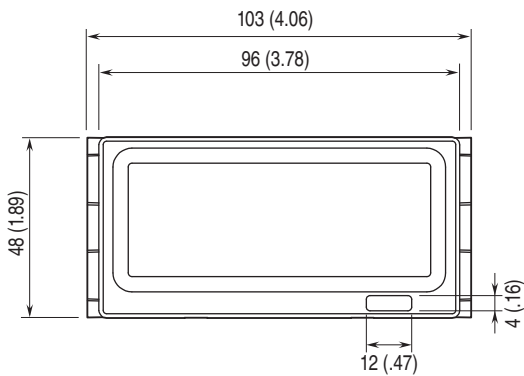

### SIDE VIEW

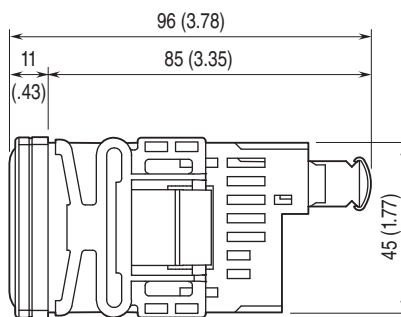

### REAR VIEW

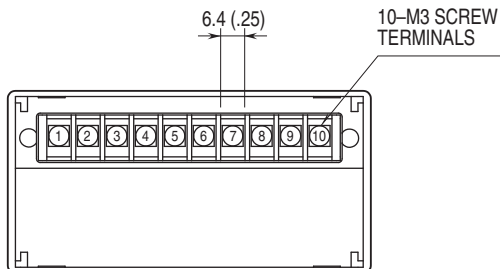

## MOUNTING REQUIREMENTS unit: mm

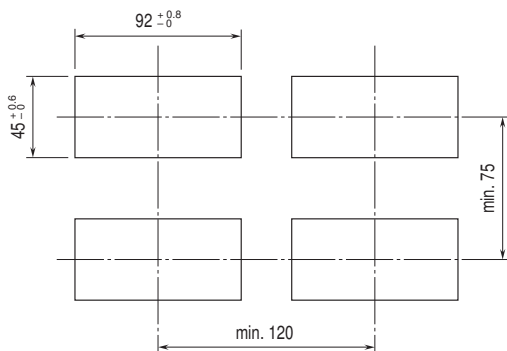

Panel thickness: 1.6 to 8.0 mm

**SCHEMATIC CIRCUITRY & CONNECTION DIAGRAM**

■ Input Code: A1, A2, A3

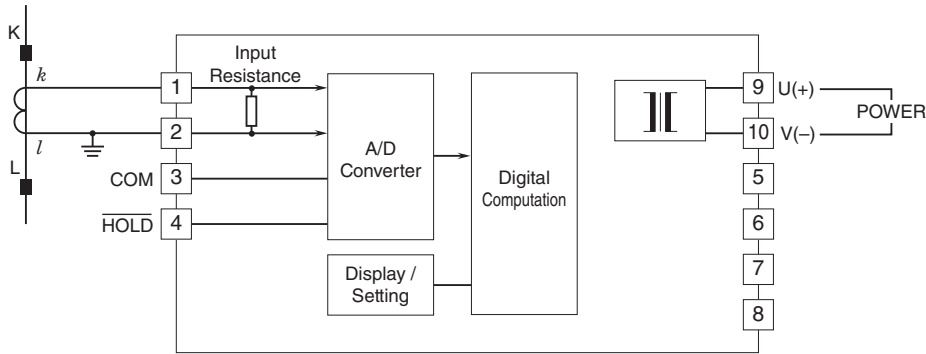

■ Input Code: A4, A5

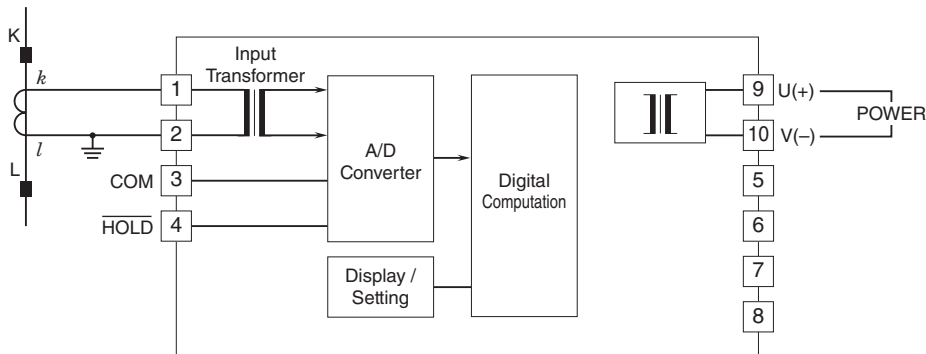

Specifications are subject to change without notice.