

## Digital Panel Meters 43 Series

/SET: Preset according to the Ordering Information Sheet (No. ESU-9425)

### LOOP POWERED DIGITAL PANEL METER

(process meter)

#### Functions & Features

- Loop powered -1999 to 9999 compact digital meter
- Scaling function
- Screwless spring terminal

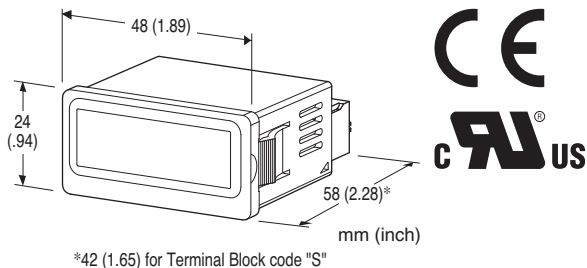

### MODEL: 43AL1-[1][2]

#### ORDERING INFORMATION

- Code number: 43AL1-[1][2]
- Specify a code from below for each of [1] and [2]. (e.g. 43AL1-D/UL/Q)
- Specify the specification for option code /Q (e.g. /C01/SET)

#### INPUT

4 - 20 mA DC

#### [1] TERMINAL BLOCK

- S: Screwless spring terminal
- D: Separable screwless spring terminal

#### [2] OPTIONS (multiple selections)

Standards & Approvals

blank: CE marking

/UL: UL approval, CE marking

Other Options

blank: none

/Q: Option other than the above (specify the specification)

#### SPECIFICATIONS OF OPTION: Q (multiple selections)

COATING (For the detail, refer to our web site.)

Moving parts and indicators are not coated.

/C01: Silicone coating

/C02: Polyurethane coating

/C03: Rubber coating (UL not available)

EX-FACTORY SETTING

#### GENERAL SPECIFICATIONS

**Construction:** Panel flush mounting

#### Connection

**Terminal block "S":** Screwless spring terminal

Applicable wire size 1.0 to 1.3 mm<sup>2</sup>, stripped length 8 mm

**Terminal block "D":** Separable screwless spring terminal

Applicable wire size 1.0 to 1.3 mm<sup>2</sup>, stripped length 8 mm

**Housing material:** Flame-resistant resin (gray)

**Isolation:** Input to FE(Functional Earth)

**A/D conversion:**  $\Sigma - \Delta$

**Sampling rate:** 10 times/sec. (100 msec.)

**Averaging:** None or moving average

**Setting:** (Front button)

- Scaled range
- Moving average

#### DISPLAY

**Display:** 4 digits of 10.2 mm (.4") height, 7-segment, red LED

**Display range:** -1999 to 9999

**Scaling range for measurement range:** -1999 to 9999 counts

**Decimal point position:** 10<sup>-1</sup>, 10<sup>-2</sup>, 10<sup>-3</sup> or none

**Zero indication:** Higher-digit zeros are suppressed.

**Over-range indication:** '-1999' or '9999' blinking for display values out of the display range. 'S.ERR' blinks surpassing the permissible range.

**Engineering unit indication:** Sticker label attached

DC, AC, mV, V, kV,  $\mu$ A, mA, A, kA, mW, W, kW, var, kvar, Mvar, VA, Hz,  $\Omega$ , k $\Omega$ , M $\Omega$ , cm, mm, m, m/sec, mm/min, cm/min, m/min, m/h, m/s<sup>2</sup>, inch, l, l/s, l/min, l/h, m<sup>3</sup>, m<sup>3</sup>/sec, m<sup>3</sup>/min, m<sup>3</sup>/h, Nm<sup>3</sup>/h, N·m, N/m<sup>2</sup>, g, kg, kg/h, N, kN, Pa, kPa, MPa, t, t/h, °C, °F, %RH, J, kJ, MJ, rpm, sec, min, pH, %, ppm, etc.

#### INPUT SPECIFICATIONS

##### ■ DC Current

**Current range:** 3.75 to 22 mA DC

**Voltage drop:** Approx. 3.5 V with 4 mA; approx. 3.7 V with 20 mA (Equivalent input impedance: Approx. 185  $\Omega$ )

(Use of the unit causes voltage drop. For 2-wire transmitter, be sure that the voltage by which 2-wire transmitter can operate is ensured including the voltage drop by other devices and wiring resistance.)

## INSTALLATION

**Operating temperature:** -10 to +55°C (14 to 131°F)

**Operating humidity:** 30 to 90 %RH (non-condensing)

**Mounting:** Panel flush mounting

**Weight:** 30 g (1.1 oz)

## PERFORMANCE

**Accuracy:**  $\pm 0.1\%$  rdg  $\pm 1$  digit  $\times$  scaling-multiple  
(When the scaling-multiple is less than 1, rounded up to 1.)

**Temp. coefficient:**  $\pm 0.3$  digits  $\times$  scaling-multiple/ $^{\circ}$ C  
(When the scaling-multiple is less than 1, rounded up to 1.)

Scaling-multiple =  $|$  (Display Scaling Value B - Display Scaling Value A)  $\div$  (default Display Scaling Value B - default Display Scaling Value A)  $|$

**Insulation resistance:**  $\geq 100$  M $\Omega$  with 500 V DC

**Dielectric strength:** 500 V AC @1 minute (input to FE)

## STANDARDS & APPROVALS

**EU conformity:**

EMC Directive

EMI EN 61000-6-4

EMS EN 61000-6-2

RoHS Directive

**Approval:**

UL/C-UL general safety requirements

(UL 61010-1, CAN/CSA-C22.2 No.61010-1-12)

## EXTERNAL VIEW

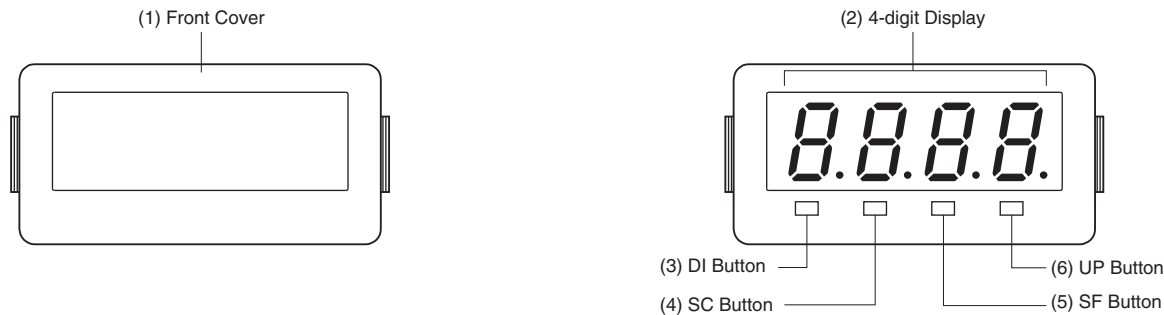

### ■ COMPONENT IDENTIFICATION

No.	COMPONENT	FUNCTIONS
(1)	Front Cover	Removed at conuguration.
(2)	4-digit Display	4-digit LED display. Range: -1999 to 9999 (not including decimal point)
(3)	DI Button	Used to move on to the display setting modes; or to shift through setting items in each setting mode.
(4)	SC Button	Used to move on to the scaling setting modes; or to shift through setting items in each setting mode.
(5)	SF Button	Used to move on to the setting standby status and shift through display digits in each setting item.
(6)	UP Button	Used to select setting value.

## PARAMETER LIST

### ■ SCALING SETTING MODE

PARAMETER	DISPLAY	FUNCTION	DEFAULT VALUE
Display Scaling Value A	-9999 ... 9999	Display value for 4 mA input To distinguish from B, the first decimal point is blinking.	0400
Display Scaling Value B	-9999 ... 9999	Display value for 20 mA input	2000
Decimal Point Position	10 <sup>-1</sup> through 10 <sup>-3</sup> or none	Decimal point position	8888

#### • Normal Scaling

The display value increases when the input signal increases.

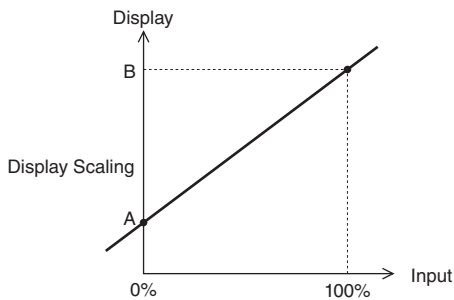

#### • Inverted Scaling

The display value decreases when the input signal increases.

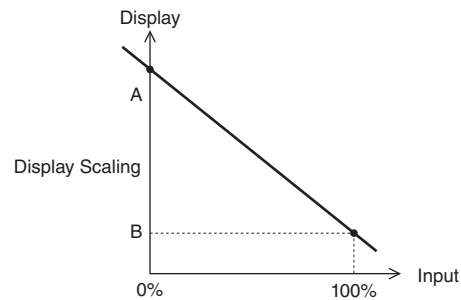

The decimal point position can be set to any digit. Set it according to the 100% value.

### ■ DISPLAY SETTING MODE

PARAMETER	DISPLAY	FUNCTION	DEFAULT VALUE
Moving Average	RoFF	No moving averaging	RoFF
	R 2	Moving average with 2 samples	
	R 4	Moving average with 4 samples	
	R 8	Moving average with 8 samples	
Initialization	r oFF	Non-initialization	r oFF
	r ESt	Initialize settings (change to factory settings) *1	
Version Indication	-	Version number, indication only	-

\*1. While "r ESt" is shown, pressing DI button or SC button initializes settings.

If "Initialization" is done once, all current parameters will be deleted and overwritten with factory default values. Notice that after this, Ex-factory settings with "/SET" option will be irrecoverable.

## EXTERNAL DIMENSIONS & TERMINAL ASSIGNMENTS unit: mm [inch]

### ■ TOP VIEW

- Separable terminal

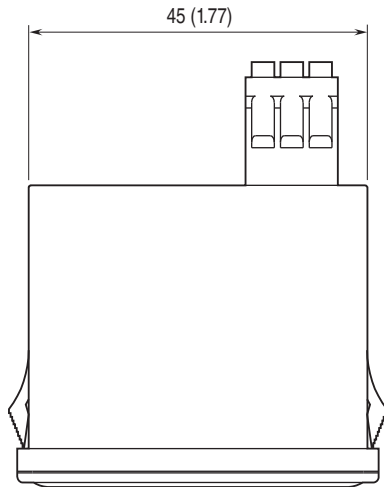

- One block terminal

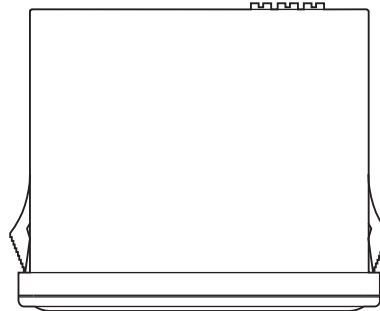

### ■ FRONT VIEW

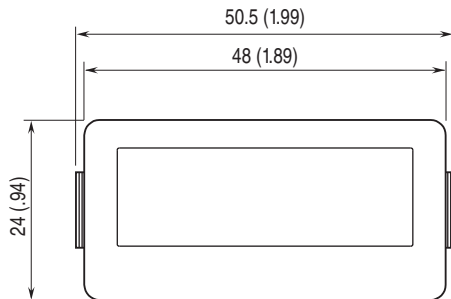

### ■ SIDE VIEW

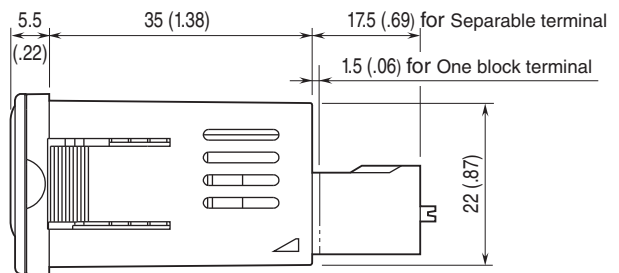

### ■ REAR VIEW

- Separable terminal

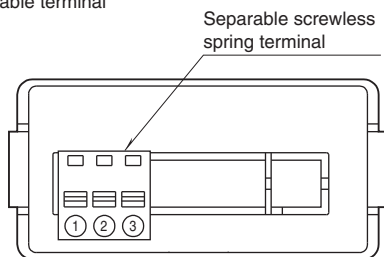

- One block terminal

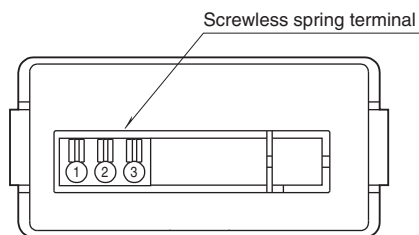

## MOUNTING REQUIREMENTS unit: mm

### ■ PANEL CUTOUT unit: mm

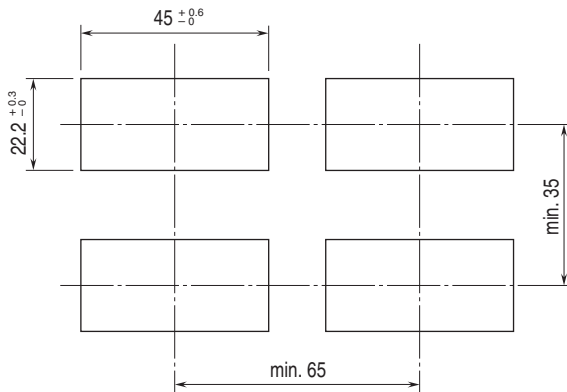

Panel thickness: 0.8 to 3.5 mm

## MOUNTING

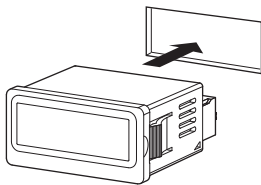

Just insert the meter body (snap-in method)

## SCHEMATIC CIRCUITRY & CONNECTION DIAGRAM

Note: In order to improve EMC performance, bond the FE terminal to ground.

Caution: FE terminal is NOT a protective conductor terminal.

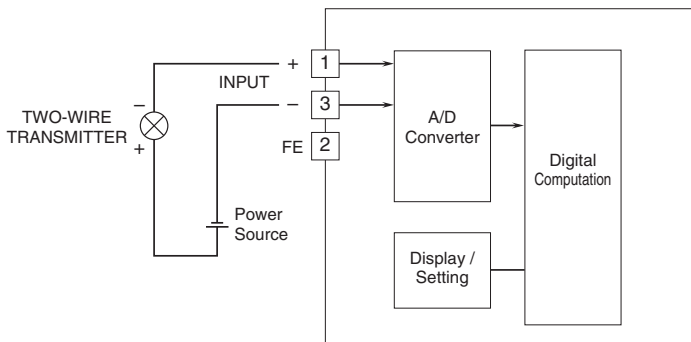

### ■ 4-WIRE CONNECTION EXAMPLE

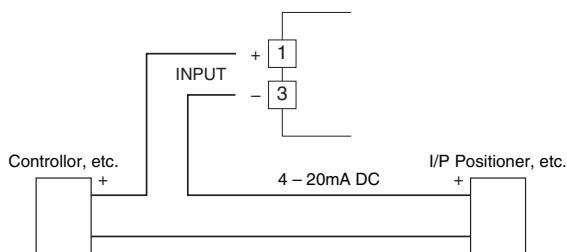



Specifications are subject to change without notice.