

## Limit Alarms (potentiometer adj.) A-UNIT

### ANGLE SENSOR ALARM

#### Functions & Features

- Providing SPDT relay outputs at preset voltage level provided from Angle Sensor (model: NRA)
- Dual (Hi/Lo) trip
- Energized or de-energized coil at a tripped condition selectable
- 50 % zero/span adjustments
- Hysteresis (deadband) adjustable
- Enclosed relays
- Relays can be powered 110 V DC
- High-density mounting

#### Typical Applications

- Annunciator
- Various alarm applications

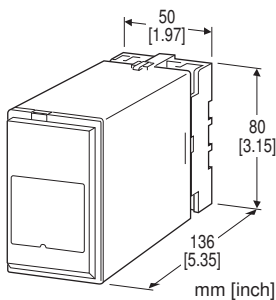

## MODEL: ANR-[1]1[2][3]-[4]

### ORDERING INFORMATION

- Code number: ANR-[1]1[2][3]-[4]
- Specify a code from below for each of [1] through [4].  
(e.g. ANR-1111-B)

#### [1] ACTION

- 1: Direct (output increases with input increase)
- 2: Reverse (output increases with input decrease)

#### [2] SETPOINT 1 OUTPUT

- 1: Hi (coil energized at alarm)
- 2: Hi (coil de-energized at alarm)
- 3: Lo (coil energized at alarm)
- 4: Lo (coil de-energized at alarm)

#### [3] SETPOINT 2 OUTPUT

- 1: Hi (coil energized at alarm)
- 2: Hi (coil de-energized at alarm)

- 3: Lo (coil energized at alarm)
- 4: Lo (coil de-energized at alarm)

### [4] POWER INPUT

- AC Power
- B: 100 V AC
  - C: 110 V AC
  - D: 115 V AC
  - F: 120 V AC
  - G: 200 V AC
  - H: 220 V AC
  - J: 240 V AC
- DC Power
- S: 12 V DC
  - R: 24 V DC
  - V: 48 V DC
  - P: 110 V DC

### RELATED PRODUCTS

- Brushless angle sensor (model: NRA)

### GENERAL SPECIFICATIONS

- Construction:** Plug-in
- Connection:** M3.5 screw terminals
- Housing material:** Flame-resistant resin (black)
- Isolation:** Input to output 1 to output 2 to power
- Zero adjustment:** 0 - 50 % of linearity-assured range of the angle sensor (front)
- Span adjustment:** 50 - 100 % of linearity-assured range of the angle sensor (front)
- Setpoint adjustments:** 270°-turn screwdriver adjustments (front); 0 - 100 % independently
- Hysteresis (deadband) adjustments:** 1 - 100 % (front)
- LEDs:** LED turns on at a tripped condition; red for output 1, green for output 2 (located behind the front cover)
- Power ON timer:** Relays de-energized for approx. 2 seconds after power is turned on.

### INPUT SPECIFICATIONS

- Input:** 2 - 3 V DC (output from Angle Sensor)
- Excitation:** 5 V DC  $\pm$ 2 %

## OUTPUT SPECIFICATIONS

■ **Relay Contact:** 100 V AC @ 1 A ( $\cos \phi = 1$ )

120 V AC @ 1 A ( $\cos \phi = 1$ )

240 V AC @ 0.5 A ( $\cos \phi = 1$ )

30 V DC @ 1 A (resistive load)

**Maximum switching voltage:** 380 V AC or 125 V DC

**Maximum switching power:** 120 VA or 30 W

**Minimum load:** 5 V DC @ 10 mA

**Mechanical life:**  $5 \times 10^7$  cycles

For maximum relay life with inductive loads, external protection is recommended.

### Alarm Trip Operation Terminal No. in parentheses

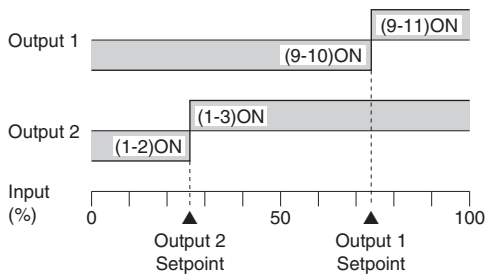

### Trip Operation in Power Failure

- **Output Code: 1 & 4:** Terminals 1 – 2, 9 – 10 turn ON
- **Output Code: 2 & 3:** Terminals 1 – 3, 9 – 11 turn ON

## INSTALLATION

### Power input

- **AC:** Operational voltage range: rating  $\pm 10\%$ , 50/60  $\pm 2$  Hz, approx. 2 VA
- **DC:** Operational voltage range: rating  $\pm 10\%$ , or 85 – 150 V for 110 V rating (ripple 10 % p-p max.) approx. 2 W (80 mA at 24 V)

**Operating temperature:** -5 to +60°C (23 to 140°F)

**Operating humidity:** 30 to 90 %RH (non-condensing)

**Mounting:** Surface or DIN rail

**Weight:** 450 g (0.99 lb)

## PERFORMANCE in percentage of span

**Trip point repeatability:**  $\pm 0.5\%$

**Temp. coefficient:**  $\pm 0.05\%/^{\circ}\text{C}$  ( $\pm 0.03\%/^{\circ}\text{F}$ )

**Response time:** Approx. 0.5 sec. (0 – 100 % at 90 % setpoint)

**Line voltage effect:**  $\pm 0.1\%$  over voltage range

**Insulation resistance:**  $\geq 100\text{ M}\Omega$  with 500 V DC

**Dielectric strength:** 2000 V AC @1 minute (input to output 1 to output 2 to power to ground)

## EXTERNAL VIEW

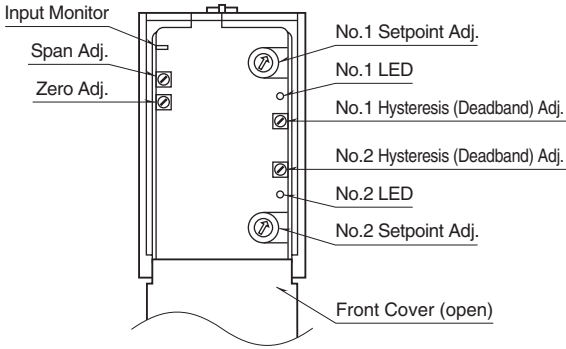

## EXTERNAL DIMENSIONS & TERMINAL ASSIGNMENTS unit: mm [inch]

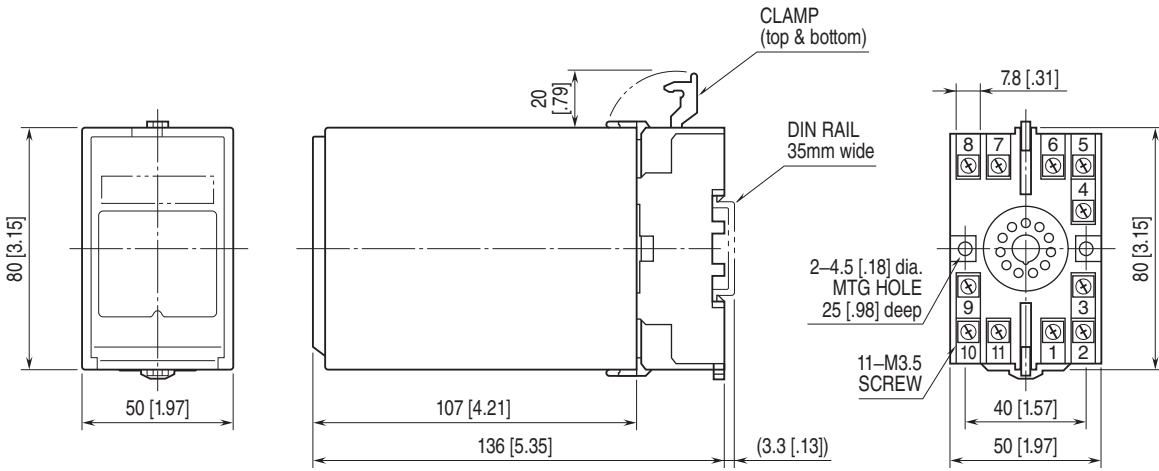

• When mounting, no extra space is needed between units.

## SCHEMATIC CIRCUITRY & CONNECTION DIAGRAM

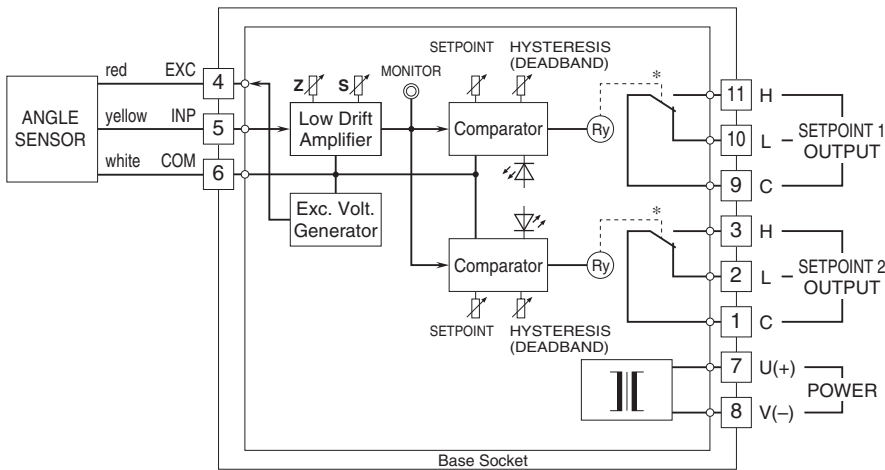

\*Relay status for output codes "1" & "4", at power OFF.

### ■ Relay Protection

#### • AC Powered

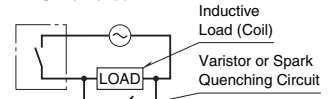

#### • DC Powered

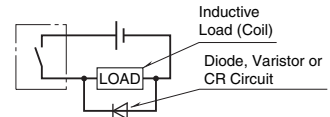



Specifications are subject to change without notice.