

## Space-saving Two-wire Signal Conditioners B-UNIT

### INPUT LOOP POWERED ISOLATOR

#### Functions & Features

- Loop-powered design eliminates output loop power supply
- 500 V DC input-to-output isolation
- 2 isolators housed in one enclosure
- 350 Ω output drive with 4 – 20 mA
- High-density mounting

#### Typical Applications

- Isolation between control room and field instrumentation, between telemetering system and input device
- Eliminates ground problems in existing systems thanks to easiness of application without requiring additional power wiring

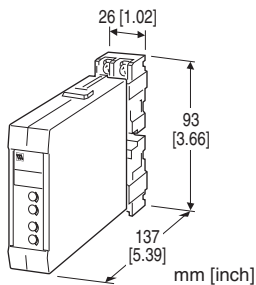

## MODEL: BSN-[1][2][3][4]

### ORDERING INFORMATION

- Code number: BSN-[1][2][3][4]
- Specify a code from below for each of [1] through [4].  
(e.g. BSN-2AA/Q)
- Specify the specification for option code /Q  
(e.g. /C01/S01)

#### [1] NO. OF CHANNELS

- 1: 1 channel  
2: 2 channels

#### [2] INPUT

- Current  
A: 4 – 20 mA DC  
H: 10 – 50 mA DC

#### [3] OUTPUT

- Current  
A: 4 – 20 mA DC  
Voltage  
6: 1 – 5 V DC

#### [4] OPTIONS

- blank: none  
/Q: With options (specify the specification)

### SPECIFICATIONS OF OPTION: Q (multiple selections)

COATING (For the detail, refer to our web site.)

- /C01: Silicone coating  
/C02: Polyurethane coating  
/C03: Rubber coating  
TERMINAL SCREW MATERIAL  
/S01: Stainless steel

### GENERAL SPECIFICATIONS

- Construction:** Plug-in  
**Connection:** M3.5 screw terminals (torque 0.8 N·m)  
**Screw terminal:** Nickel-plated steel (standard) or stainless steel  
**Housing material:** Flame-resistant resin (black)  
**Isolation:** Input to output; between channels  
**Zero adjustment (front)**  
**Voltage output:** -5 to +5 %  
**Current output:** -0.5 to +0.5 %  
**Span adjustment (front)**  
**Voltage output:** 95 to 105 %  
**Current output:** 98.5 to 101.5 %

### INPUT & OUTPUT

- **Input 4 – 20 mA DC / Output 1 – 5 V DC**  
**Equivalent input impedance:** Approx. 250 Ω with 20 mA input  
**Operational range:** 3 – 22 mA DC  
(Accuracy is assured within 4 – 22 mA)  
**Load resistance:** ≥ 50 kΩ
- **Input 10 – 50 mA DC / Output 1 – 5 V DC**  
**Equivalent input impedance:** Approx. 100 Ω with 50 mA input  
**Operational range:** 7 – 55 mA DC  
(Accuracy is assured within 8 – 55 mA)  
**Load resistance:** ≥ 50 kΩ
- **Input 4 – 20 mA DC / Output 4 – 20 mA DC**  
**Equivalent input impedance:** 230 Ω plus load resistance with 20 mA input  
**Operational range:** 3 – 22 mA DC  
(Accuracy is assured within 4 – 22 mA)  
**Load resistance:** 50 – 350 Ω (min. 50 Ω required for adequate operation)
- **Input 10 – 50 mA DC / Output 4 – 20 mA DC**  
**Equivalent input impedance:** 90 Ω + [load resistance × 0.16]

with 50 mA input

**Operational range:** 7 – 55 mA DC

(Accuracy is assured within 8 – 55 mA)

**Load resistance:** 50 – 600 Ω (min. 50 Ω required for adequate operation)

•INPUT 4 – 20 mA DC / OUTPUT 1 – 5 V DC

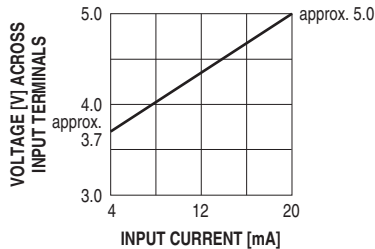

•INPUT 10 – 50 mA DC / OUTPUT 1 – 5 V DC

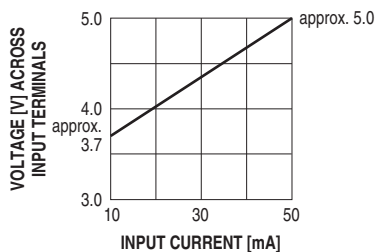

•INPUT 4 – 20mA DC / OUTPUT 4 – 20 mA DC

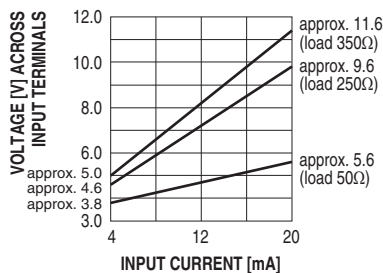

•INPUT 10 – 50 mA DC / OUTPUT 4 – 20 mA DC

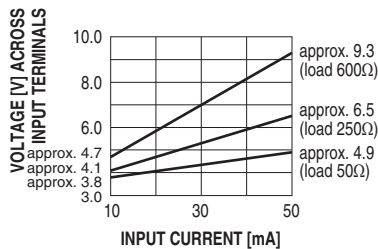

**Voltage output:** ±0.015 %/°C (±0.008 %/°F)

**Current output:** ±0.02 %/°C (±0.01 %/°F)

**Response time**

**Voltage output:** ≤ 0.5 sec. (0 – 90 %)

**Current output**

**4 – 20 mA DC input:** Approx. 15 msec. (0 – 90 %, 50 Ω load)

**10 – 50 mA DC input:** Approx. 8 msec. (0 – 90 %, 50 Ω load)

**Load effect (current output)**

**4 – 20 mA input:** 0.015 %/Ω (50 – 150 Ω)

0.003 %/Ω (150 – 350 Ω)

**10 – 50 mA input:** 0.015 %/Ω (50 – 100 Ω)

0.003 %/Ω (100 – 600 Ω)

(The unit is calibrated with 250 Ω load at the factory.)

**Insulation resistance:** ≥ 100 MΩ with 500 V DC

**Dielectric strength:**

500 V AC @1 minute (input to output)

1500 V AC @1 minute (between channels)

1500 V AC @1 minute (input or output to ground)

## INSTALLATION

**Operating temperature:** -5 to +55°C (23 to 131°F)

**Operating humidity:** 30 to 90 %RH (non-condensing)

**Mounting:** Surface or DIN rail; Standard Rack Mounting

Frame BX-16H available

**Weight:** 200 g (0.44 lb)

## PERFORMANCE in percentage of span

**Accuracy:** ±0.1 %

**Temp. coefficient**

## EXTERNAL DIMENSIONS & TERMINAL ASSIGNMENTS unit: mm [inch]

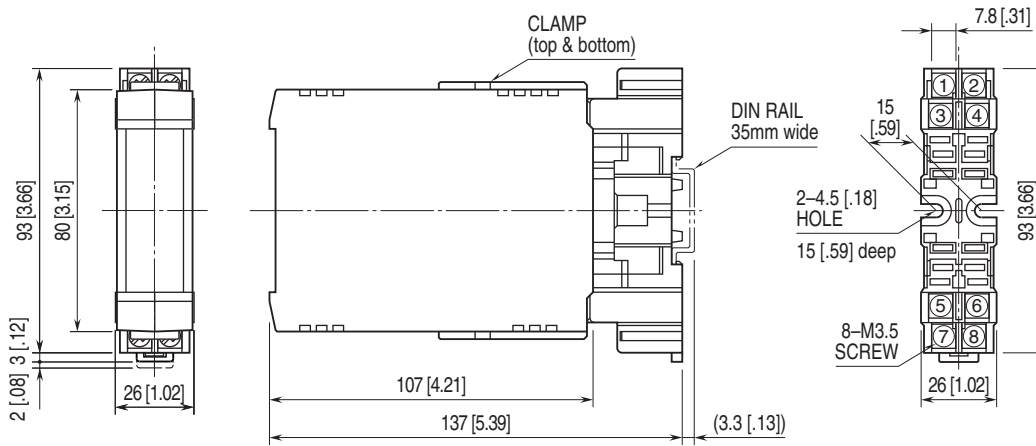

•When mounting, no extra space is needed between units.

## SCHEMATIC CIRCUITRY & CONNECTION DIAGRAM

Note: For the single-channel model, the terminals 3 - 4 and 7 - 8 are used.

### ■ VOLTAGE OUTPUT

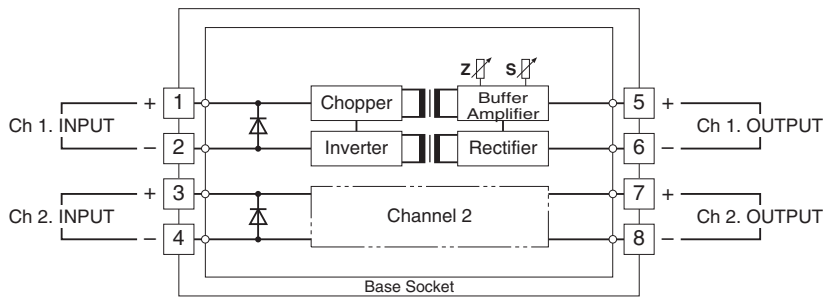

### ■ CURRENT OUTPUT

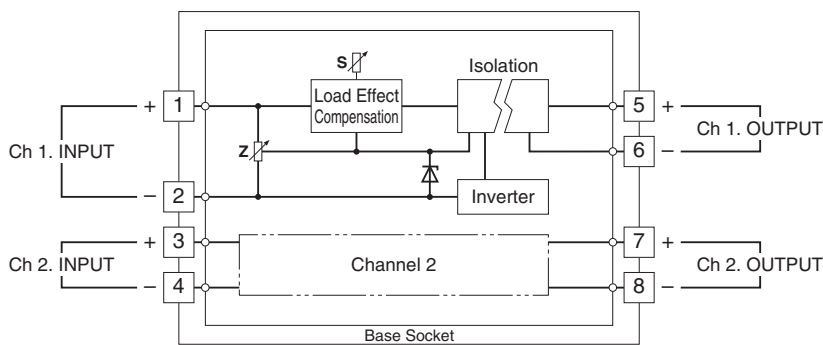

Specifications are subject to change without notice.