

CLAMP-ON CURRENT SENSOR

Functions & Features

- Easy-to-install, spring-loaded, clamp-on type current sensor
- Over-voltage clamp element for safety in open circuit
- Wide frequency band
- Screw terminal connection

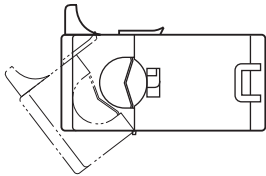

MODEL: CLSB-[1]

ORDERING INFORMATION

- Code number: CLSB-[1]

Specify a code from below for [1].

(e.g. CLSB-05)

Confirm the correct sensor type described on the data sheet of the combined transducer/transmitter module.

[1] INPUT

R5: 5 A

05: 50 A

10: 100 A

20: 200 A

40: 400 A

60: 600 A

CAUTION

Before you remove the sensor module or mount it, turn off the input signal for safety. While the line is alive, the module's cores, attracted to each other, may be hard to separate.

RELATED PRODUCTS

- CLSB-05, 10, 20, 40 and 60

- AC current input module (model: R3-CT4B)
- AC current input module (model: R3-CT8B)
- AC current input module (model: R5T-CTB)
- AC current transducer (model: 14CEC)
- AC current transducer (model: LTCEC)
- CT transmitter (model: CTC)
- High AC current transmitter (model: CTCS)
- CT transmitter (model: KCEC)
- AC current transmitter (model: M2CEC)
- CT transmitter (model: M5CTC)

- CT converter (model: M8CTC)
- CT transmitter (model: M6xCTC)

- CLSB-05 and 10

- Multi power input module (model: R3-WT1B)
- Multi power input module (model: R3-WT4B)

- CLSB-R5

- AC current input module (model: R3-CT4C)
- AC current input module (model: R3-CT8C)

GENERAL SPECIFICATIONS

Construction: Clamp

Connection: M3 screw terminals (torque 0.5 N·m)

Housing material: Flame-resistant resin (black)

Applicable wire size: AWG22 or thicker (Max. 30 meters, twisted)

Detachable number of times: Approx. 100 times

INPUT SPECIFICATIONS

Max. working voltage: 440 V AC (primary side)

(Refer to the instruction manual for detail.)

Operational range & overload capacity

CLSB-R5: 5 A maximum 10 A continuous

CLSB-05: 50 A maximum 100 A continuous

CLSB-10: 100 A maximum 200 A continuous

CLSB-20: 200 A maximum 300 A continuous

CLSB-40: 400 A maximum 600 A continuous

CLSB-60: 600 A maximum 720 A continuous

Caution 1: The output values may vary depending on the accuracy of engagement at the clamp connection.

Caution 2: The sensor's mechanical construction may cause it to generate resonance sound. However, it does not affect the performance of the sensor.

INSTALLATION

Operating temperature: -10 to +55°C (14 to 131°F)

Operating humidity: 30 to 90 %RH (non-condensing)

Mounting: Fix with a binding strap.

Weight

CLSB-R5: 45 g (1.6 oz)

CLSB-05: 45 g (1.6 oz)

CLSB-10: 80 g (2.8 oz)

CLSB-20: 200 g (7.1 oz)

CLSB-40: 300 g (10.6 oz)

CLSB-60: 360 g (12.7 oz)

PERFORMANCE

Accuracy: ±1 % (45 - 65 Hz)

±2 % (65.1 Hz - 1.2 kHz) (except the CLSB-60)

Insulation resistance: ≥ 100 MΩ with 500 V DC (sensor core to output terminal)

Dielectric strength: 1000 V AC @ 1 minute
(sensor core to output terminal)

EXTERNAL DIMENSIONS unit: mm [inch]

■ Sensor model No.: CLSB-R5

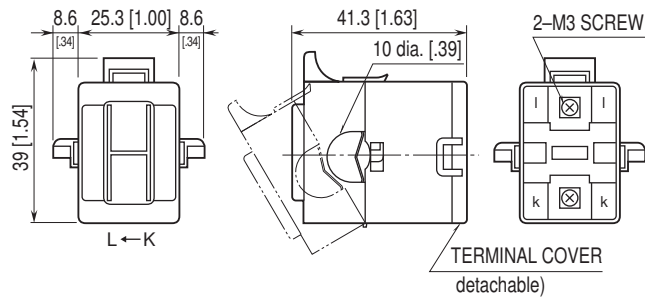

■ Sensor model No.: CLSB-05

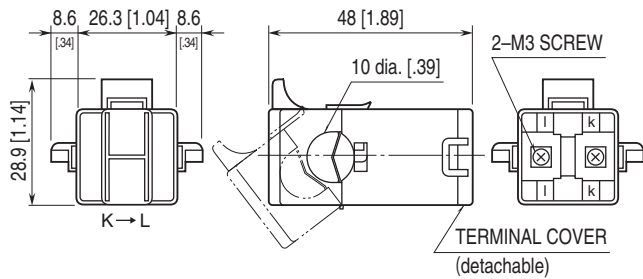

■ Sensor model No.: CLSB-10

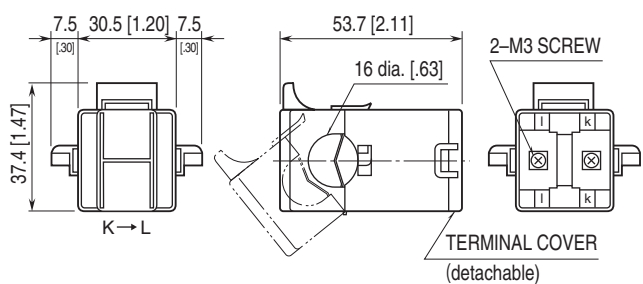

■ Sensor model No.: CLSB-20

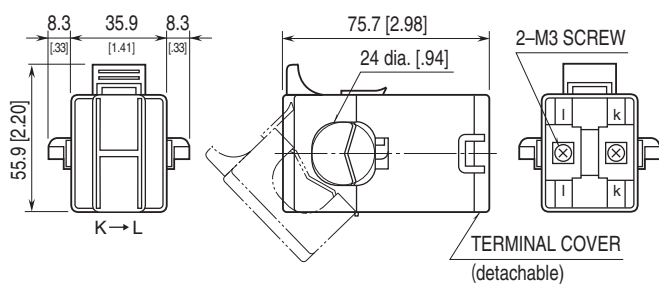

■ Sensor model No.: CLSB-40

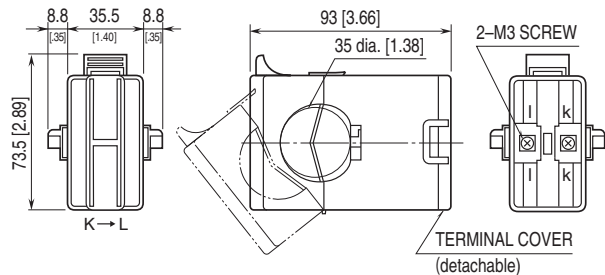

■ Sensor model No.: CLSB-60

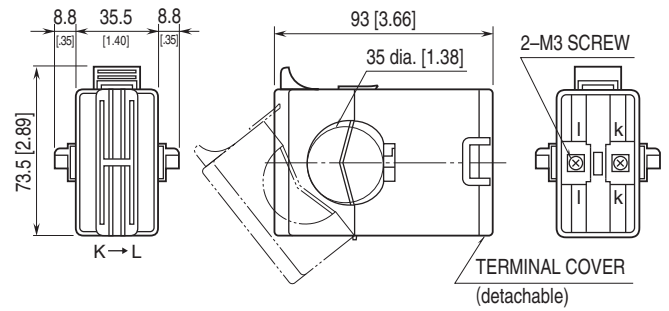



Specifications are subject to change without notice.