

Multiplex Transmission System

STANDARD MULTI-TRANSMISSION UNIT

Functions & Features

- Multiple transmission system without any software by setting station No.
- All-in-one (self-contained) hardware
- Twisted-pair cable or fiber optics
- Expansion and branching with Repeaters (model: DAL4)
- Removable terminal block
- Error detection
- Monitor LEDs provided for contact I/O units

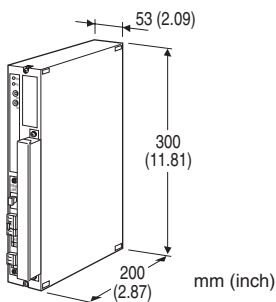

MODEL: DLA1-[1][2]-[3][4]

ORDERING INFORMATION

- Code number: DLA1-[1][2]-[3][4]
 - Specify a code from below for each of [1] through [4].
(e.g. DLA1-2A1-R/Q)
 - Specify the specification for option code /Q
(e.g. /C01)
- Refer to each unit specifications.

[1] TRANSMISSION MEDIA

- 1: Twisted-pair cable
- 2: Fiber optics cable
- 7: Twisted-pair - fiber optics (repeater incorporated)

[2] I/O SECTION

- A1:** Di 32 points
- A2:** Di 64 points
- C1:** Do 32 points (relay)
- C2:** Do 32 points (open collector)
- C3:** Do 64 points (relay)
- C4:** Do 64 points (open collector)
- E1:** Di 16 + Do 16 points (relay)
- E2 :** Di 16 + Do 16 points (open collector)
- G1x:** Ai 32 points
- M1x:** Ao 32 points

- P1x :** Pi 16 + Ai 16 points
- R1xx:** Ai 16 + Ao 16 points
- S1xx:** Ai 8 + Ao 8 + Di 8 + Do 8 points
- U1x :** Po 16 + Ao 16 points

[3] POWER INPUT

- AC Power
- K:** 85 - 132 V AC
(Operational voltage range 85 - 132 V, 47 - 66 Hz)
- L:** 170 - 264 V AC
(Operational voltage range 170 - 264 V, 47 - 66 Hz)
- DC Power
- S:** 12 V DC
(Operational voltage range 12 V \pm 10 %, ripple 10 %p-p max.)
- R:** 24 V DC
(Operational voltage range 24 V \pm 10 %, ripple 10 %p-p max.)

[4] OPTIONS

- blank:** none
- /Q:** With options (specify the specification)

SPECIFICATIONS OF OPTION: Q

- COATING (For the detail, refer to our web site.)
- /C01:** Silicone coating
- /C02:** Polyurethane coating
- /C03:** Rubber coating

RELATED PRODUCTS

- Remote I/O interface unit (model: DLC)
- Telemetry unit (model: DLS)
- Repeater (model: DAL4)
- Lightning surge protector (model: MDP-DM3)
- Adapter connector (model: CND)

GENERAL SPECIFICATIONS

- Construction:** Surface mounting; terminal access on the front
- Connection**
- Transmission line terminal:** Euro type connector terminal
(Applicable wire size: $\leq 1.25 \text{ mm}^2$, stripped length 8 mm)
- Power supply terminal:** Euro type connector terminal
(Applicable wire size: $\leq 1.25 \text{ mm}^2$, stripped length 8 mm)
- RUN contact:** Euro type connector terminal
(Applicable wire size: $\leq 1.25 \text{ mm}^2$, stripped length 8 mm)
- I/O section:**
- **32-point I/O (or less):** 40-pin connector terminal; M3 \times 6 screws (torque 0.7 N·m)
- **64-point I/O:** FCN 40-pin connector (two); OTAX N365P040AU (FUJITSU FCN-365P040-AU...discontinued)

Housing material: Flame-resistant resin (beige)

Isolation: I/O to transmission section to power

Station No. setting: 2 rotary switches; 00 - FF (256)

■ Controller & Transmission Sections

Power indicator: Red LED turns ON in normal conditions; OFF when the voltage level becomes low.

RUN indicator: Red LED turns OFF in error.

■ I/O Section

Contact I/O indicator LED: Red LEDs turn on when the respective I/O channels are ON.

Analog I/O CPU RUN indicator LED: Red LED turns ON when the CPU function proves normal, OFF in error.

■ **RUN Contact Output:** Contact opens in error.

Rated load: 100 V AC or 30 V DC @ 1 A (resistive load)

Maximum switching voltage: 120 V AC or 30 V DC

Maximum switching power: 100 VA or 30 W

Minimum load: 5 V DC @ 10 mA

Error detection

• **Communication:** The receiver units detect loss of communication and wire break.

• **CPU:** Watch-dog timer

• **Power voltage:** Detects when the voltage supply to the CPU drops by 10 %.

MULTIPLEX COMMUNICATION

Communication: Half-duplex, synchronous

Transmission: Conform to RS-422, EIA

Transmission speed: 125 kbps

Protocol: SIN-NET (dedicated; data format conforms to SDLC)

Error check: CRC

■ Twisted-pair Cable

Cable: CPEV-0.9 dia.

Connection: Euro Type connector terminal

(Applicable wire size: $\leq 1.25 \text{ mm}^2$, stripped length 8 mm)

Transmission Distance: 1 kilometer max. with 16 units connected; 3 kilometers max. between 2 stations each of which consists of 3 units

Terminator: Incorporated (Remove the attached jumper pin when the unit is not located at the end of transmission line.)

■ Fiber Optics Cable

Link: JIS F07 connector (Consult factory for details)

Transmission distance: 1 kilometer max. with PCF

Transmission loss: 7 dB max.

■ **Twisted-pair - Fiber Optics:** Converting signals between two media and waveform shaping

INSTALLATION

Power consumption

• **AC:** Approx. 17.5 VA

• **DC:** Approx. 17 W (1.1 A with 24 V)

Grounding: Not required in normal environments; 100 Ω or less grounding resistance in noisy environments

Operating temperature: -5 to + 50°C (23 to 122°F)

Operating humidity: 30 to 90 %RH (non-condensing)

Atmosphere: No corrosive gas or heavy dust

Mounting: Surface; Rack Mounting Frame (model: BX-1DL) available

Weight: 2 kg (4.4 lb)

PERFORMANCE

Permissible power failure duration

• **AC:** $\leq 20 \text{ ms}$

• **DC:** $\leq 1 \text{ ms}$

Insulation resistance: $\geq 100 \text{ M}\Omega$ with 500 V DC

Dielectric strength: 1500 V AC @ 1 minute (I/O to transmission to power to ground)

DESCRIPTIONS

■ RUN Contact (LED) Behaviors

Input units

Input units (A1, A2, G1 and P1): The LED turns ON with the network built-up; OFF in error; the network is reconfigured after an error.

•Connecting the input unit to the DLC

The LED remains ON regardless of the input command of the DLC.

Output units

Output units (C1, C2, C3, C4, M1 and U1): The LED turns ON when data from the paired input unit is received normally, with the network configured; OFF when the data is lost; turns also OFF in error in the network.

Transmission via the DLS units: The LED remains ON regardless of the input unit status or telecomm. line status, once it is turned ON.

•Connecting the output unit to the DLC

After the output unit receives the output command from the DLC, the LED turns ON and remains ON regardless of the data update.

I/O-mixed units (E1, E2, R1 and S1): The LED turns ON when data from the paired input unit is received normally, with the network configured; OFF in case of data loss or network error.

•Connecting the I/O-mixed unit to the DLC

After the I/O unit receives the output command from the DLC regardless whether input or output, the LED turns ON and remains ON regardless of the data update.

[CAUTION]

When the network is reconfigured e.g. by noise interference, the RUN LED and output for all units on the network turn briefly OFF until they are turned ON after the reconfiguration is complete.

■ Station Number (Address)

A) 1 input unit and X output units: Match the address for input and output units. The input data can be output at several units. A 64-point input unit needs two station numbers. Do not assign the number following the one set for a 64-point input unit to another unit.

B) 64-point contact input unit to 32-point output units: Match the number for input and one output units, then set a consecutive number for the other output unit.

[example]

input unit → 01

output unit → 01 & 02

C) 32-point contact input units to 64-point output unit: Match the number for the output and one input units, then set a consecutive number for the other input unit.

[example]

input unit → 01 & 02

output unit → 01

D) I/O mixed units: Set an even number and a consecutive number for the 2 corresponding units.

[example] 02 & 03

A combination of 3 units or more is not allowed.

E) Computer interface: Set address numbers to correspond with the computer as I/O unit.

■ Transmission Time

Integrate all the transmission time for each process input unit in the system.

- Contact input 32 points (A1): 1.5 msec.
- Contact input 64 points (A2): 3.0 msec.
- Contact I/O each 16 points (E1): 1.5 msec.
- Analog input 32 points (G1): 48.0 msec.
- Analog/pulse Input each 16 points (P1): 48.0 msec.
- Analog I/O each 16 points (R1): 24.0 msec.
- Analog & contact I/O each 8 points (S1): 12.0 msec.

An analog unit does not transmit all its points in serial but does 1 point per each cycle. For example, when 1 contact input unit and 1 analog input unit (32 points for each) are connected, 32 point contact signal and 1 point analog signal are transmitted in

turn. One cycle time is therefore calculated as:

$$32 \text{ times} \times 1.5 \text{ msec.} + 48 \text{ msec.} = 96 \text{ msec.}$$

This method is beneficial for giving a priority to contact signals which vary rapidly.

■ TRANSMISSION LINE CONFIGURATION

1. BASIC CONDITIONS

The multi-drop transmission line should fulfill the following conditions. Contact M-System's sales office or representatives when designing.

A) 10 kilometers at maximum in total system.

B) Twisted-pair cable (code 1): a multi-drop section composed only of twisted-pair cable can have at maximum of 16 units within the total distance of 1 kilometer.

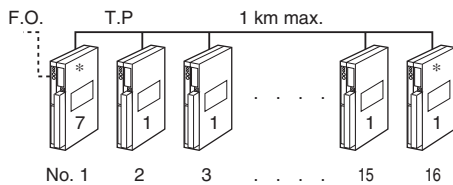

1 & 7 : TRANSMISSION MEDIA CODE
T.P. : TWISTED-PAIR CABLE
F.O. : FIBER OPTICS CABLE

C) Fiber optics cable (code 2): a system can have at maximum of 6 multi-drop sections composed only of fiber optics. Insert a pair of units of code "7" for waveform shaping between each 5 units of code "2".
1 kilometer max. between each unit.

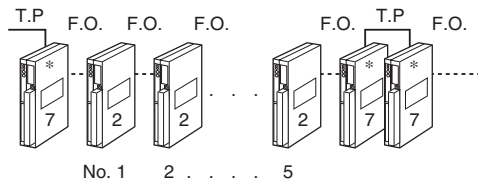

2 & 7 : TRANSMISSION MEDIA CODE
T.P. : TWISTED-PAIR CABLE
F.O. : FIBER OPTICS CABLE

D) Twisted-pair & fiber optics (code 7): a transmission line can have at maximum of 8 units of code "7". Units of code "1" and "2" can be mixed in each section within the above limitation.

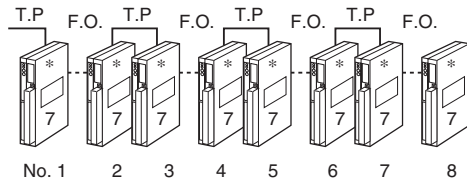

7 : TRANSMISSION MEDIA CODE
T.P. : TWISTED-PAIR CABLE
F.O. : FIBER OPTICS CABLE

* Marked units are located at the end of transmission line via twisted-pair cable. Short across the terminals 6 – 7 with the jumper pin provided with the units.

2. LONG DISTANCE TRANSMISSION

A) Twisted-pair transmission between point A to point B:

3 kilometers at maximum between two points when 3 units are mounted closely side by side at each point. With each additional unit, the distance is reduced by 100 meters.

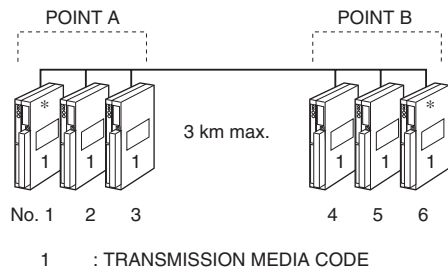

B) Twisted-pair cable between 6 points (special case of 1-D)

2 kilometers at maximum with twisted-pair cable between each point. 4 sections at maximum with fiber optics; 1 kilometer at maximum for each section. Total distance within 10 kilometers.

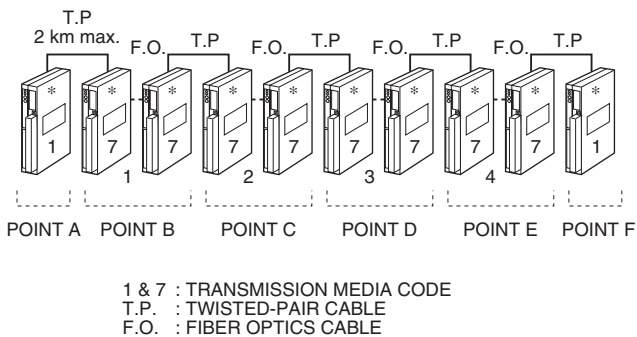

* Marked units are located at the end of transmission line via twisted-pair cable. Short across the terminals 6–7 with the jumper pin provided with the units.

3. INTERSECTION

When units cannot be connected in serial, use a pair of units of code "7" at the intersection (marked with *) or model DAL4.

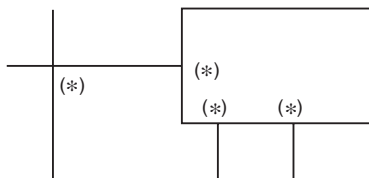

(detail of the intersection)

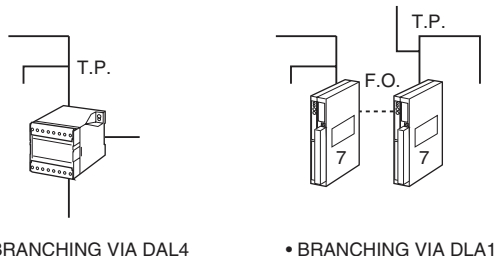

4. COMBINATION WITH MODEL DAL4

2 kilometers max. between two DAL4 units. 1 kilometer max. when there are other units between the DAL4 units. Total number of DAL4 on the transmission line must be 6 units or less, with the total distance 10 kilometers max.

■ CONBINATION TABLE

	POSSIBLE COMBINATION		REMARKS
DLA1-xA1 (Di 32 points)	DLA1-xC1 (Do 32 points) DLA1-xC3 (Do 64 points)	DLA1-x C2 (Do 32 points) DLA1-x C4 (Do 64 points)	Two A1 units required for one C3 or C4 unit.
DLA1-xA2 (Di 64 points)	DLA1-xC1 (Do 32 points) DLA1-xC3 (Do 64 points)	DLA1-x C2 (Do 32 points) DLA1-x C4 (Do 64 points)	Two C1 or C2 units required for one A2 unit.
DLA1-xC1 (Do 32 points) DLA1-xC2 (Do 32 points)	DLA1-xA1 (Di 32 points)	DLA1-x A2 (Di 32 points)	Two C1 or C2 units required for one A2 unit.
DLA1-xC3 (Do 64 points) DLA1-xC4 (Do 64 points)	DLA1-xA1 (Di 32 points)	DLA1-x A2 (Di 32 points)	Two A1 units required for one C3 or C4 unit.
DLA1-xE1 (Di 16 + Do 16) DLA1-xE2 (Di 16 + Do 16)	DLA1-xE1 (Di 16 + Do 16) DLA1-xE2 (Di 16 + Do 16)		
DLA1-xG1 (Ai 32 points)	DLA1-xM1 (Ao 32 points)		
DLA1-xM1 (Ao 32 points)	DLA1-xG1 (Ai 32 points)		
DLA1-xP1 (Pi 16 + Ai 16)	DLA1-xU1 (Po 16 + Ao 16) DLA1-xM1 (Ao 16 [accum. value] + Ao 16)		M1 output analog signal in proportion to accumulated pulse.
DLA1-xR1 (Ai 16 + Ao 16)	DLA1-xR1 (Ai 16 + Ao 16)		
DLA1-xS1 (Ai 8+ Ao 8+ Di 8+ Do 8)	DLA1-xS1 (Ai 8 + Ao 8 + Di 8 + Do 8)		
DLA1-xU1 (Po 16 + Ao 16)	DLA1-xP1 (Pi 16 + Ai 16)		

EXTERNAL VIEW

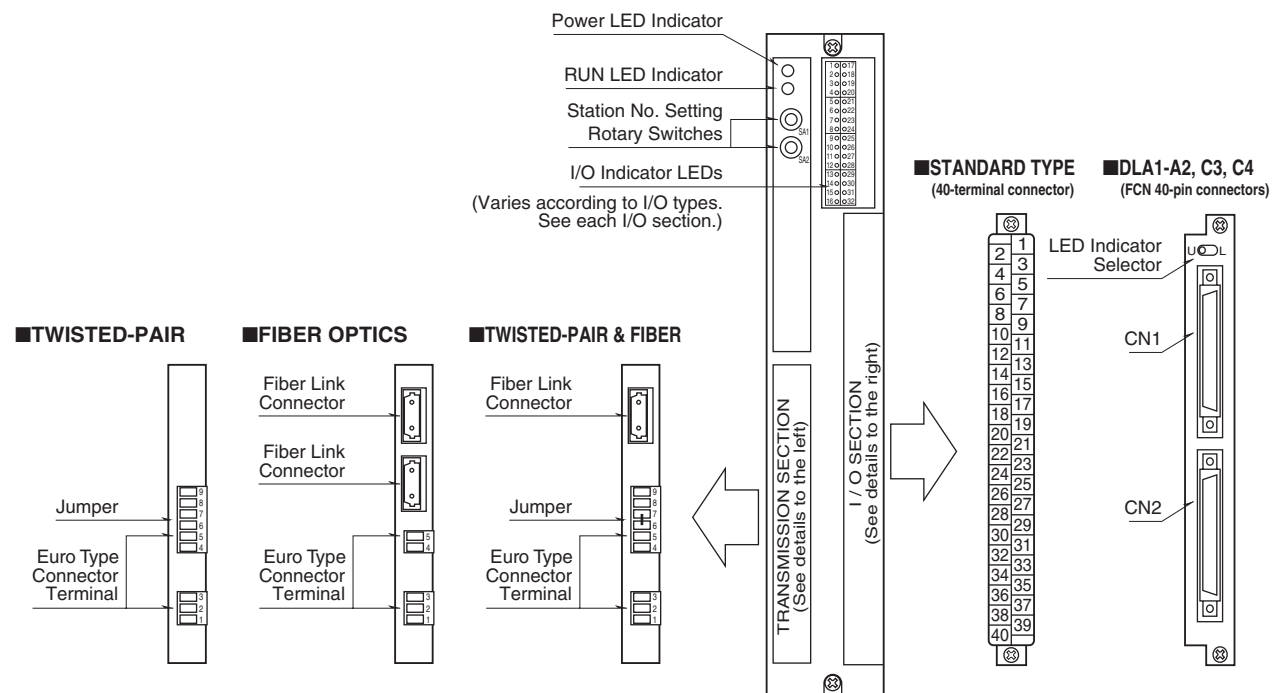

CONNECTION DIAGRAM

■ TWISTED-PAIR CABLE (transmission media code: 1)

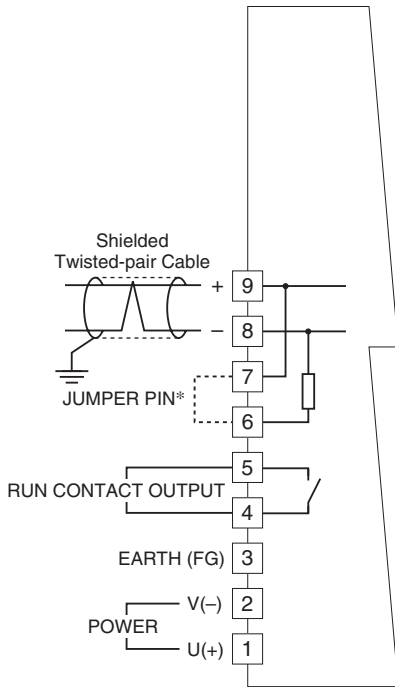

■ FIBER OPTICS CABLE (transmission media code: 2)

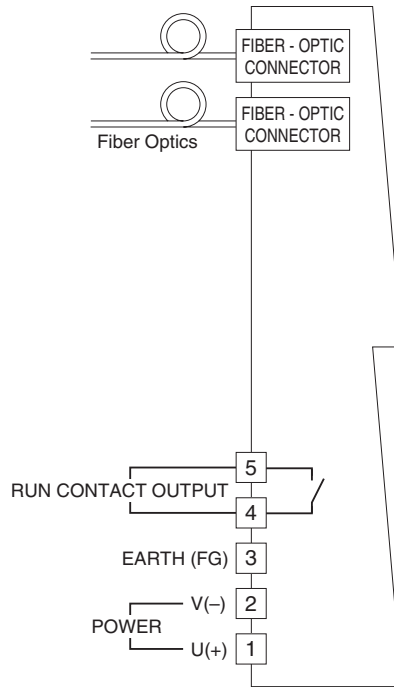

■ TWISTED-PAIR & FIBER OPTICS (transmission media code: 7)

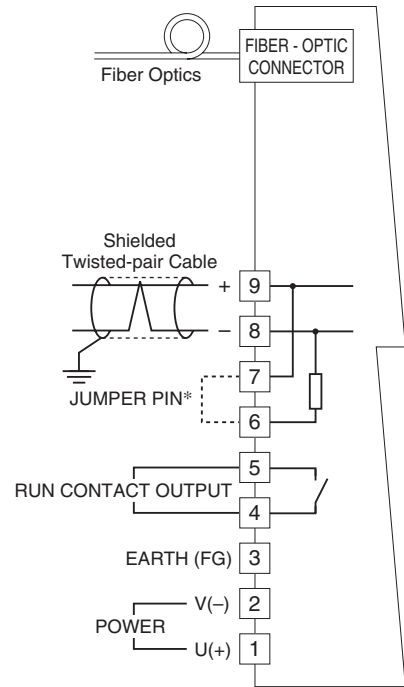

*When the unit is located at the end of transmission line via twisted-pair cable (= no cross-wiring), short across the terminals 6 – 7 with the jumper pin (or wire) provided with the unit. Remove the jumper pin for the one not located at the end.

EXTERNAL DIMENSIONS unit: mm [inch]

■ STANDARD TYPE (DLA1-xA1, xC1, xC2, xE1, xE2, xG1, xM1, xP1, xR1, xS1, xU1)

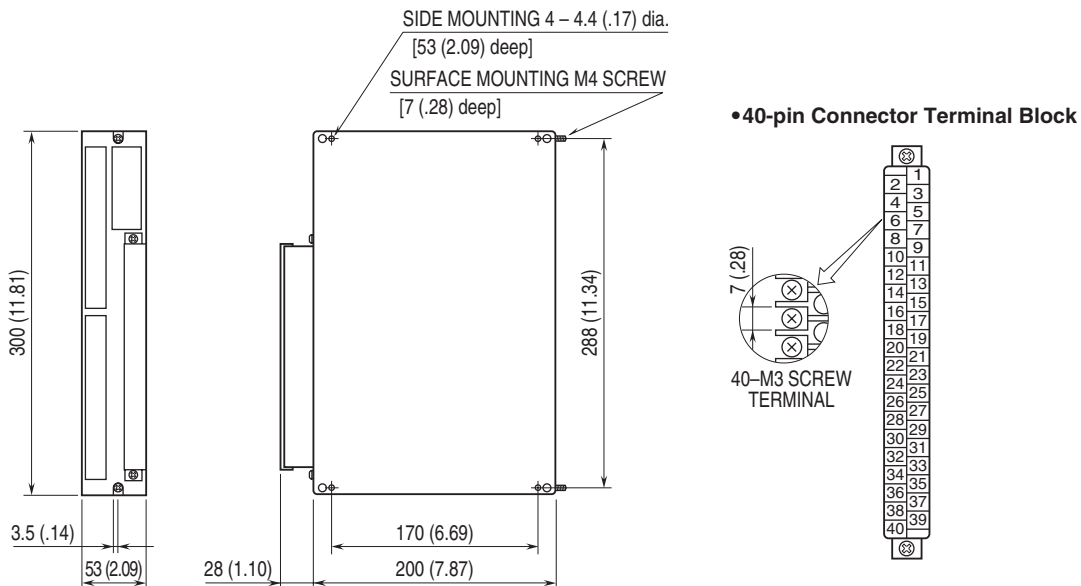

■ WITH I/O CONNECTORS (DLA_x-xA2, xC3, xC4)

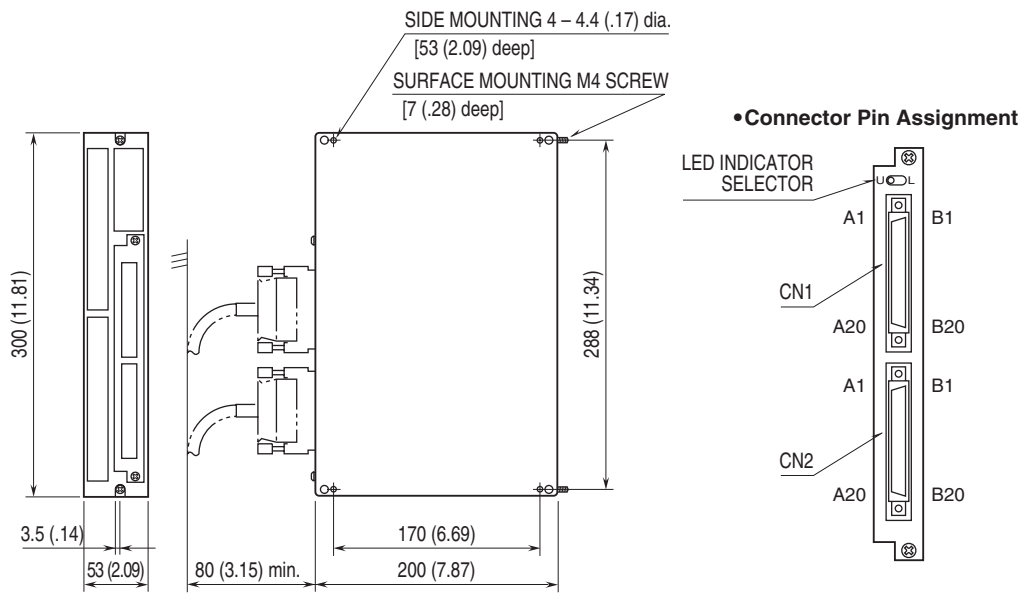

•Terminal Assignment, Euro Type Connector Terminals

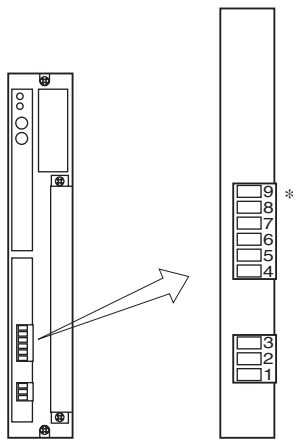

•Wiring Procedure of Euro Type Connector Terminals

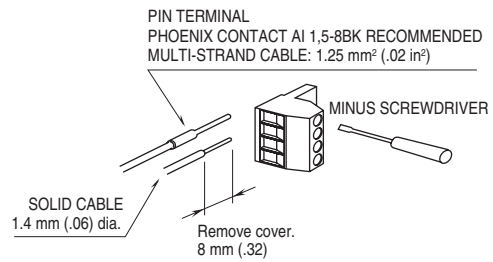

*Not provided for fiber optics (code 2)
Note : There is no specific order for connecting fiber optics.

MOUNTING REQUIREMENTS unit: mm [inch]

■ SURFACE MOUNTING

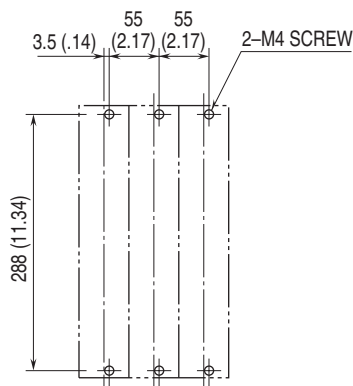

■ SIDE MOUNTING (terminal block at the right side)

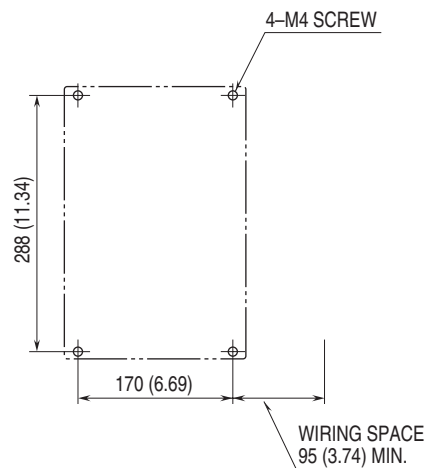

FUNCTION BLOCK DIAGRAM

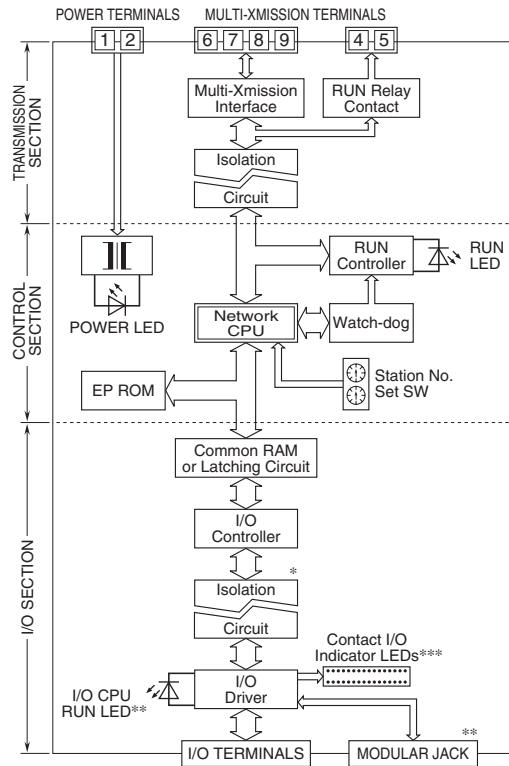

*Deleted with Codes G1, P1, R1 or S1.
 **Deleted with Codes A1, A2, C1, C2, C3, C4, E1 or E2.
 ***Deleted with Codes G1, M1, R1.

CONTACT INPUT UNIT

(Di 32 points)

MODEL: DLA1-[1]A1-[2][3]

ORDERING INFORMATION

- Code number: DLA1-[1]A1-[2][3]
Specify a code from below for each of [1] through [3].
(e.g. DLA1-2A1-K/Q)
- Specify the specification for option code /Q
(e.g. /C01)

[1] TRANSMISSION MEDIA

- 1: Twisted-pair cable
- 2: Fiber optics cable
- 7: Twisted-pair - fiber optics (repeater incorporated)

[2] POWER INPUT

AC Power

K: 85 - 132 V AC

(Operational voltage range 85 - 132 V, 47 - 66 Hz)

L: 170 - 264 V AC

(Operational voltage range 170 - 264 V, 47 - 66 Hz)

DC Power

S: 12 V DC

(Operational voltage range 12 V \pm 10 %, ripple 10 %p-p max.)

R: 24 V DC

(Operational voltage range 24 V \pm 10 %, ripple 10 %p-p max.)

[3] OPTIONS

blank: none

/Q: With options (specify the specification)

SPECIFICATIONS OF OPTION: Q

COATING (For the detail, refer to our web site.)

/C01: Silicone coating

/C02: Polyurethane coating

/C03: Rubber coating

GENERAL SPECIFICATIONS

Connection

Input: 40-pin connector terminal;

M3 screws (torque: 0.7 N·m)

Applicable wire size: 0.75 mm²

Isolation: Input to transmission to power

Contact input indicator LED: Red LEDs turn on when the respective input channels are ON.

INPUT SPECIFICATIONS

Input: Dry contact, 32 points

Commons: All negatives

Sensing: Approx. 15 V DC @ 3 mA

ON/OFF level: \leq 200 Ω for ON; \geq 100 k Ω for OFF

PERFORMANCE

Multi-transmission time: 1.5 msec.

Input read time: 5 msec. per 32 points

EXTERNAL VIEW

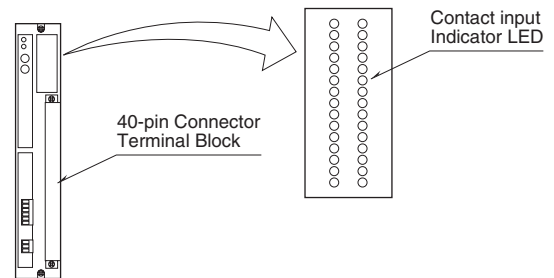

CONNECTION DIAGRAM

INPUT

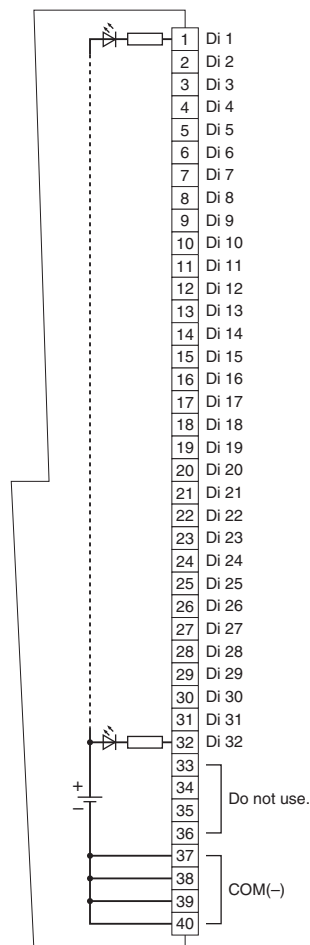

CONTACT INPUT UNIT

(Di 64 points)

MODEL: DLA1-[1]A2-[2][3]

ORDERING INFORMATION

- Code number: DLA1-[1]A2-[2][3]
Specify a code from below for each of [1] through [3].
(e.g. DLA1-2A2-K/Q)
- Specify the specification for option code /Q
(e.g. /C01)

[1] TRANSMISSION MEDIA

- 1: Twisted-pair cable
- 2: Fiber optics cable
- 7: Twisted-pair - fiber optics (repeater incorporated)

[2] POWER INPUT

- AC Power
- K:** 85 - 132 V AC
(Operational voltage range 85 - 132 V, 47 - 66 Hz)
- L:** 170 - 264 V AC
(Operational voltage range 170 - 264 V, 47 - 66 Hz)
- DC Power
- S:** 12 V DC
(Operational voltage range 12 V ±10 %, ripple 10 %p-p max.)
- R:** 24 V DC
(Operational voltage range 24 V ±10 %, ripple 10 %p-p max.)

[3] OPTIONS

- blank:** none
- /Q:** With options (specify the specification)

SPECIFICATIONS OF OPTION: Q

- COATING (For the detail, refer to our web site.)
- /C01:** Silicone coating
- /C02:** Polyurethane coating
- /C03:** Rubber coating

RELATED PRODUCTS

- Connector terminal block (model: CNT)
- Special cable with 40-pin connector (model: FCN)

GENERAL SPECIFICATIONS

Connection

- Input:** FCN 40-pin connector (two);
(OTAX N365P040AU)
(FUJITSU FCN-365P040-AU...discontinued)

LED indicator selector: Switching between CN1 (U) and CN2 (L)

Isolation: Input to transmission to power

Contact input indicator LED: Red LEDs turn on when the respective input channels are ON.

INPUT SPECIFICATIONS

- Input:** Dry contact, 64 points
- Commons:** All negatives
- Sensing:** Approx. 15 V DC @ 3 mA
- ON/OFF level:** ≤ 200 Ω for ON; ≥ 100 kΩ for OFF

PERFORMANCE

- Multi-transmission time:** 3 msec.
- Input read time:** 10 msec. per 64 points

EXTERNAL VIEW

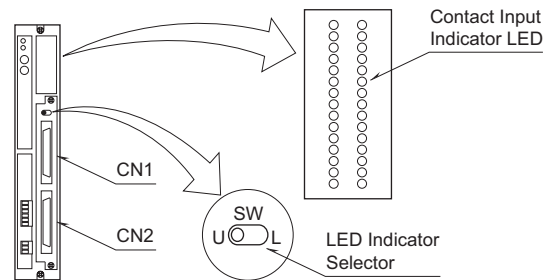

CONNECTOR PIN ASSIGNMENT

■ CONNECTOR CN1				■ CONNECTOR CN2			
PIN NO.	CH. NO.	PIN NO.	CH. NO.	PIN NO.	CH. NO.	PIN NO.	CH. NO.
A1	Di 1	B1	Di17	A1	Di33	B1	Di49
2	2	2	18	2	34	2	50
3	3	3	19	3	35	3	51
4	4	4	20	4	36	4	52
5	5	5	21	5	37	5	53
6	6	6	22	6	38	6	54
7	7	7	23	7	39	7	55
8	8	8	24	8	40	8	56
9	9	9	25	9	41	9	57
10	10	10	26	10	42	10	58
11	11	11	27	11	43	11	59
12	12	12	28	12	44	12	60
13	13	13	29	13	45	13	61
14	14	14	30	14	46	14	62
15	15	15	31	15	47	15	63
16	16	16	32	16	48	16	64
17	C1	17	C1	17	C1	17	C1
18	C1	18	C1	18	C1	18	C1
19	C1	19	C1	19	C1	19	C1
20	C1	20	C1	20	C1	20	C1

C1: negative common to all channels

CONTACT OUTPUT UNIT

(Do 32 points; relay contact)

MODEL: DLA1-[1]C1-[2][3]

ORDERING INFORMATION

- Code number: DLA1-[1]C1-[2][3]
Specify a code from below for each of [1] through [3].
(e.g. DLA1-2C1-K/Q)
- Specify the specification for option code /Q
(e.g. /C01)

[1] TRANSMISSION MEDIA

- 1: Twisted-pair cable
- 2: Fiber optics cable
- 7: Twisted-pair - fiber optics (repeater incorporated)

[2] POWER INPUT

- AC Power
- K:** 85 - 132 V AC
(Operational voltage range 85 - 132 V, 47 - 66 Hz)
 - L:** 170 - 264 V AC
(Operational voltage range 170 - 264 V, 47 - 66 Hz)
- DC Power
- S:** 12 V DC
(Operational voltage range 12 V \pm 10 %, ripple 10 %p-p max.)
 - R:** 24 V DC
(Operational voltage range 24 V \pm 10 %, ripple 10 %p-p max.)

[3] OPTIONS

- blank:** none
- /Q:** With options (specify the specification)

SPECIFICATIONS OF OPTION: Q

- COATING (For the detail, refer to our web site.)
- /C01:** Silicone coating
 - /C02:** Polyurethane coating
 - /C03:** Rubber coating

GENERAL SPECIFICATIONS

- Connection**
- Output:** 40-pin connector terminal; M3 screws
(torque 0.7 N·m)
 - Applicable wire size:** 0.75 mm²
 - Isolation:** Output to transmission to power
 - Contact output indicator LED:** Red LEDs turn on when the respective output channels are ON.

OUTPUT SPECIFICATIONS

- Commons:** Per 4 points; common current 4A max.
 - Output:** Relay contact, 32 points
 - Contact rating:** 120 V AC @ 1 A (cos ϕ = 1)
30 V DC @ 1 A (resistive load)
 - Maximum switching voltage:** 120 V AC or 30 V DC
 - Maximum switching power:** 120 VA or 30 W
 - Minimum load:** 5 V DC @ 10 mA
 - Mechanical life:** 5 x 10⁷ cycles
- For maximum relay life with inductive loads, external protection is recommended.

PERFORMANCE

- Output time**
- OFF to ON:** 8 msec. per 32 points
 - ON to OFF:** 3 msec. per 32 points

EXTERNAL VIEW

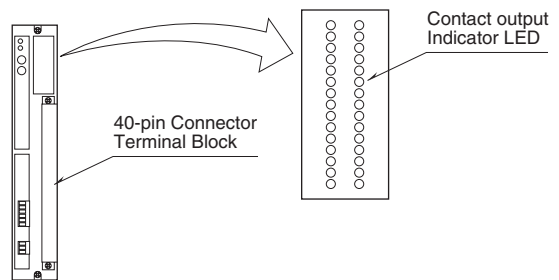

CONNECTION DIAGRAM

■ OUTPUT

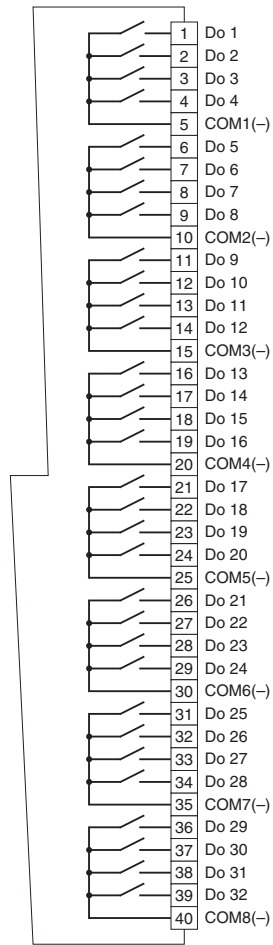

CONTACT OUTPUT UNIT

(Do 32 points; open collector)

MODEL: DLA1-[1]C2-[2][3]

ORDERING INFORMATION

- Code number: DLA1-[1]C2-[2][3]
Specify a code from below for each of [1] through [3].
(e.g. DLA1-2C2-K/Q)
- Specify the specification for option code /Q
(e.g. /C01)

[1] TRANSMISSION MEDIA

- 1: Twisted-pair cable
- 2: Fiber optics cable
- 7: Twisted-pair - fiber optics (repeater incorporated)

[2] POWER INPUT

AC Power

K: 85 - 132 V AC

(Operational voltage range 85 - 132 V, 47 - 66 Hz)

L: 170 - 264 V AC

(Operational voltage range 170 - 264 V, 47 - 66 Hz)

DC Power

S: 12 V DC

(Operational voltage range 12 V \pm 10 %, ripple 10 %p-p max.)

R: 24 V DC

(Operational voltage range 24 V \pm 10 %, ripple 10 %p-p max.)

[3] OPTIONS

blank: none

/Q: With options (specify the specification)

SPECIFICATIONS OF OPTION: Q

COATING (For the detail, refer to our web site.)

/C01: Silicone coating

/C02: Polyurethane coating

/C03: Rubber coating

GENERAL SPECIFICATIONS

Connection

Output: 40-pin connector terminal; M3 screws
(torque 0.7 N·m)

Applicable wire size: 0.75 mm²

Isolation: Output to transmission to power

Contact output indicator LED: Red LEDs turn on when the respective output channels are ON.

OUTPUT SPECIFICATIONS

Commons: All negatives

Output: Open collector, 32 points

Contact rating: 30 V DC @ 100 mA (resistive load) External protection is recommended with inductive loads.

Saturation voltage: 1.6 V DC

PERFORMANCE

Output time: 3 msec. per 32 points

EXTERNAL VIEW

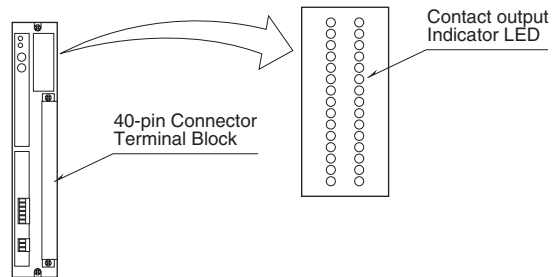

CONNECTION DIAGRAM

■ OUTPUT

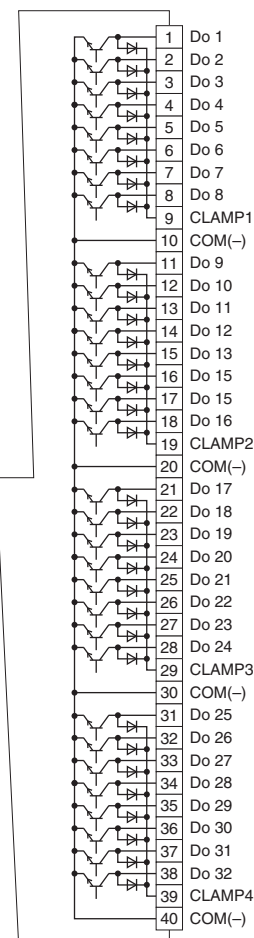

CONTACT OUTPUT UNIT

(Do 64 points; relay contact)

MODEL: DLA1-[1]C3-[2][3]

ORDERING INFORMATION

- Code number: DLA1-[1]C3-[2][3]
Specify a code from below for each of [1] through [3].
(e.g. DLA1-2C3-K/Q)
- Specify the specification for option code /Q
(e.g. /C01)

[1] TRANSMISSION MEDIA

- 1: Twisted-pair cable
- 2: Fiber optics cable
- 7: Twisted-pair - fiber optics (repeater incorporated)

[2] POWER INPUT

- AC Power
- K:** 85 - 132 V AC
(Operational voltage range 85 - 132 V, 47 - 66 Hz)
- L:** 170 - 264 V AC
(Operational voltage range 170 - 264 V, 47 - 66 Hz)
- DC Power
- S:** 12 V DC
(Operational voltage range 12 V \pm 10 %, ripple 10 %p-p max.)
- R:** 24 V DC
(Operational voltage range 24 V \pm 10 %, ripple 10 %p-p max.)

[3] OPTIONS

- blank:** none
- /Q:** With options (specify the specification)

SPECIFICATIONS OF OPTION: Q

- COATING (For the detail, refer to our web site.)
- /C01:** Silicone coating
- /C02:** Polyurethane coating
- /C03:** Rubber coating

RELATED PRODUCTS

- Connector terminal block (model: CNT)
- Special cable with 40-pin connector (model: FCN)

GENERAL SPECIFICATIONS

- Connection:**
- Output:** FCN 40-pin connector (two);
(OTAX N365P040AU)
(FUJITSU FCN-365P040-AU...discontinued)
- LED indicator selector:** Switching between CN1 (U) and CN2 (L)
- Isolation:** Output to transmission to power
- Contact output indicator LED:** Red LEDs turn on when the respective output channels are ON.

OUTPUT SPECIFICATIONS

- Common:** Per 4 points
- Common current:** Max. 0.8 A
- Output:** Relay contact, 64 points
- Contact rating:** 120 V AC @ 0.8 A ($\cos \phi = 1$)
30 V DC @ 0.8 A (resistive load)
- Maximum switching voltage:** 120 V AC or 30 V DC
- Maximum switching power:** 96 VA or 24 W
- Minimum load:** 5 V DC @ 10 mA
- Mechanical life:** 5×10^7 cycles
- For maximum relay life with inductive loads, external protection is recommended.

PERFORMANCE

- Output time**
- OFF to ON:** 8 msec. per 64 points
- ON to OFF:** 6 msec. per 64 points

EXTERNAL VIEW

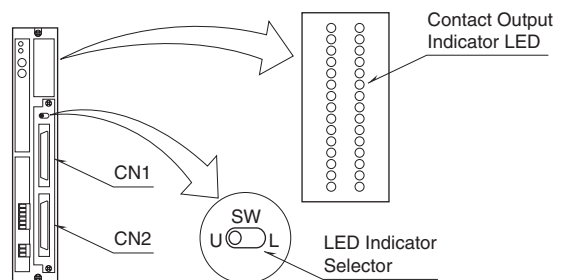

CONNECTOR PIN ASSIGNMENT

■ CONNECTOR CN1				■ CONNECTOR CN2			
PIN NO.	CH. NO.	PIN NO.	CH. NO.	PIN NO.	CH. NO.	PIN NO.	CH. NO.
A1	Do 1	B1	Do17	A1	Do33	B1	Do49
2	2	2	18	2	34	2	50
3	3	3	19	3	35	3	51
4	4	4	20	4	36	4	52
17	C1	17	C5	17	C9	17	C13
5	Do 5	5	Do21	5	Do37	5	Do53
6	6	6	22	6	38	6	54
7	7	7	23	7	39	7	55
8	8	8	24	8	40	8	56
18	C2	18	C6	18	C10	18	C14
9	Do 9	9	Do25	9	Do41	9	Do57
10	10	10	26	10	42	10	58
11	11	11	27	11	43	11	59
12	12	12	28	12	44	12	60
19	C3	19	C7	19	C11	19	C15
13	Do13	13	Do29	13	Do45	13	Do61
14	14	14	30	14	46	14	62
15	15	15	31	15	47	15	63
16	16	16	32	16	48	16	64
20	C4	20	C8	20	C12	20	C16

C1 – C16: negative common per 4 points

CONTACT OUTPUT UNIT

(Do 64 points; open collector)

MODEL: DLA1-[1]C4-[2][3]

ORDERING INFORMATION

- Code number: DLA1-[1]C4-[2][3]
Specify a code from below for each of [1] through [3].
(e.g. DLA1-2C4-K/Q)
- Specify the specification for option code /Q
(e.g. /C01)

[1] TRANSMISSION MEDIA

- 1: Twisted-pair cable
- 2: Fiber optics cable
- 7: Twisted-pair - fiber optics (repeater incorporated)

[2] POWER INPUT

- AC Power
K: 85 - 132 V AC
 (Operational voltage range 85 - 132 V, 47 - 66 Hz)
L: 170 - 264 V AC
 (Operational voltage range 170 - 264 V, 47 - 66 Hz)
 DC Power
S: 12 V DC
 (Operational voltage range 12 V ±10 %, ripple 10 %p-p max.)
R: 24 V DC
 (Operational voltage range 24 V ±10 %, ripple 10 %p-p max.)

[3] OPTIONS

- blank:** none
/Q: With options (specify the specification)

SPECIFICATIONS OF OPTION: Q

- COATING (For the detail, refer to our web site.)
/C01: Silicone coating
/C02: Polyurethane coating
/C03: Rubber coating

RELATED PRODUCTS

- Connector terminal block (model: CNT)
- Special cable with 40-pin connector (model: FCN)

GENERAL SPECIFICATIONS

- Connection:**
Output: FCN 40-pin connector (two);
 (OTAX N365P040AU)
 (FUJITSU FCN-365P040-AU...discontinued)

LED indicator selector: Switching between CN1 (U) and CN2 (L)

Isolation: Output to transmission to power

Contact output indicator LED: Red LEDs turn on when the respective output channels are ON.

OUTPUT SPECIFICATIONS

- Commons:** All negatives
Output: Open collector, 64 points
Contact rating: 30 V DC @ 100 mA (resistive load)
 External protection is recommended with inductive loads.
Saturation voltage: 1.6 V DC

PERFORMANCE

Output time: 6 msec. per 64 points

EXTERNAL VIEW

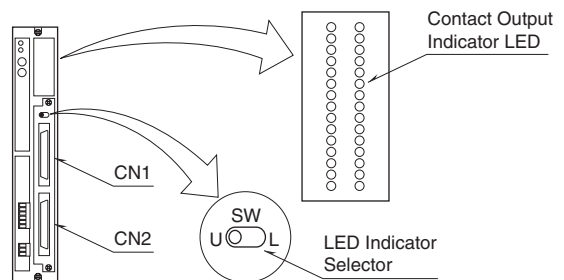

CONNECTOR PIN ASSIGNMENT

■ CONNECTOR CN1				■ CONNECTOR CN2			
PIN NO.	CH. NO.	PIN NO.	CH. NO.	PIN NO.	CH. NO.	PIN NO.	CH. NO.
A1	Do 1	B1	Do17	A1	Do33	B1	Do49
2	2	2	18	2	34	2	50
3	3	3	19	3	35	3	51
4	4	4	20	4	36	4	52
5	5	5	21	5	37	5	53
6	6	6	22	6	38	6	54
7	7	7	23	7	39	7	55
8	8	8	24	8	40	8	56
17	C1	17	C1	17	C1	17	C1
18	C1	18	C1	18	C1	18	C1
9	Do 9	9	Do25	9	Do41	9	Do57
10	10	10	26	10	42	10	58
11	11	11	27	11	43	11	59
12	12	12	28	12	44	12	60
13	13	13	29	13	45	13	61
14	14	14	30	14	46	14	62
15	15	15	31	15	47	15	63
16	16	16	32	16	48	16	64
19	C1	19	C1	19	C1	19	C1
20	CL1	20	CL2	20	CL3	20	CL4

C1: negative common to all channels
 CL1 - CL4: clamp terminals per 16 points

CONTACT I/O UNIT

(Di 16 + Do 16 points; relay contact output)

MODEL: DLA1-[1]E1-[2][3]

ORDERING INFORMATION

- Code number: DLA1-[1]E1-[2][3]
Specify a code from below for each of [1] through [3].
(e.g. DLA1-2E1-K/Q)
- Specify the specification for option code /Q
(e.g. /C01)

[1] TRANSMISSION MEDIA

- 1: Twisted-pair cable
- 2: Fiber optics cable
- 7: Twisted-pair - fiber optics (repeater incorporated)

[2] POWER INPUT

- AC Power
- K:** 85 - 132 V AC
(Operational voltage range 85 - 132 V, 47 - 66 Hz)
- L:** 170 - 264 V AC
(Operational voltage range 170 - 264 V, 47 - 66 Hz)
- DC Power
- S:** 12 V DC
(Operational voltage range 12 V \pm 10 %, ripple 10 %p-p max.)
- R:** 24 V DC
(Operational voltage range 24 V \pm 10 %, ripple 10 %p-p max.)

[3] OPTIONS

- blank:** none
- /Q:** With options (specify the specification)

SPECIFICATIONS OF OPTION: Q

- COATING (For the detail, refer to our web site.)
- /C01:** Silicone coating
- /C02:** Polyurethane coating
- /C03:** Rubber coating

GENERAL SPECIFICATIONS

- Connection:**
- I/O:** 40-pin connector terminal; M3 screws
(torque 0.7 N·m)
- Applicable wire size:** 0.75 mm²
- Isolation:** I/O to transmission to power
- Contact I/O indicator LED:** Red LEDs turn on when the respective I/O channels are ON.

INPUT SPECIFICATIONS

- Input:** Dry contact, 16 points
- Commons:** All negatives
- Sensing:** Approx. 15 V DC @ 3 mA
- ON/OFF level:** \leq 200 Ω for ON; \geq 100 k Ω for OFF

OUTPUT SPECIFICATIONS

- Commons:** Per 4 points; common current 4A max.
- Output:** Relay contact, 16 points
- Contact rating:** 120 V AC @ 1 A (cos ϕ = 1)
30 V DC @ 1 A (resistive load)
- Maximum switching voltage:** 120 V AC or 30 V DC
- Maximum switching power:** 120 VA or 30 W
- Minimum load:** 5 V DC @ 10 mA
- Mechanical life:** 5×10^7 cycles
- For maximum relay life with inductive loads, external protection is recommended.

PERFORMANCE

- Multi-transmission time:** 1.5 msec.
- Input read time:** 3 msec. per 16 points
- Output time**
- OFF to ON:** 8 msec. per 16 points
- ON to OFF:** 3 msec. per 16 points

EXTERNAL VIEW

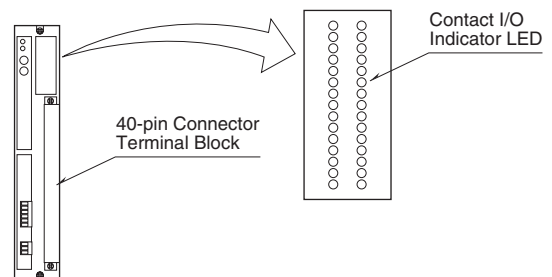

CONNECTION DIAGRAM

■ I/O

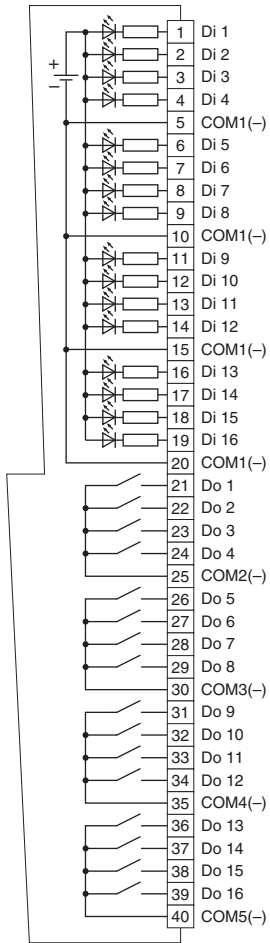

CONTACT I/O UNIT

(Di 16 + Do 16 points; open collector output)

MODEL: DLA1-[1]E2-[2][3]

ORDERING INFORMATION

- Code number: DLA1-[1]E2-[2][3]
Specify a code from below for each of [1] through [3].
(e.g. DLA1-2E2-K/Q)
- Specify the specification for option code /Q
(e.g. /C01)

[1] TRANSMISSION MEDIA

- 1: Twisted-pair cable
- 2: Fiber optics cable
- 7: Twisted-pair - fiber optics (repeater incorporated)

[2] POWER INPUT

AC Power

K: 85 - 132 V AC

(Operational voltage range 85 - 132 V, 47 - 66 Hz)

L: 170 - 264 V AC

(Operational voltage range 170 - 264 V, 47 - 66 Hz)

DC Power

S: 12 V DC

(Operational voltage range 12 V \pm 10 %, ripple 10 %p-p max.)

R: 24 V DC

(Operational voltage range 24 V \pm 10 %, ripple 10 %p-p max.)

[3] OPTIONS

blank: none

/Q: With options (specify the specification)

SPECIFICATIONS OF OPTION: Q

COATING (For the detail, refer to our web site.)

/C01: Silicone coating

/C02: Polyurethane coating

/C03: Rubber coating

GENERAL SPECIFICATIONS

Connection:

I/O: 40-pin connector terminal; M3 screws
(torque 0.7 N·m)

Applicable wire size: 0.75 mm²

Isolation: I/O to transmission to power

Contact I/O indicator LED: Red LEDs turn on when the respective I/O channels are ON.

INPUT SPECIFICATIONS

Input: Dry contact, 16 points

Commons: All negatives

Sensing: Approx. 15 V DC @ 3 mA

ON/OFF level: \leq 200 Ω for ON; \geq 100 k Ω for OFF

OUTPUT SPECIFICATIONS

Commons: All negatives

Output: Open collector, 16 points

Contact rating: 30 V DC @ 100 mA (resistive load)

External protection is recommended with inductive loads.

Saturation voltage: 1.6 V DC

PERFORMANCE

Multi-transmission time: 1.5 msec.

Input read time: 3 msec. per 16 points

Output time: 3 msec. per 16 points

EXTERNAL VIEW

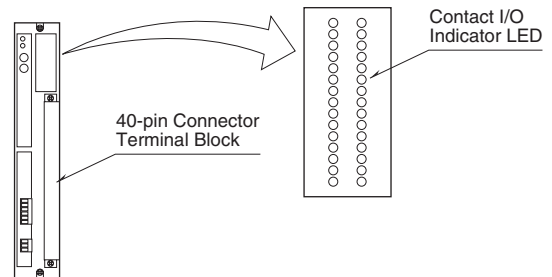

CONNECTION DIAGRAM

■ I/O

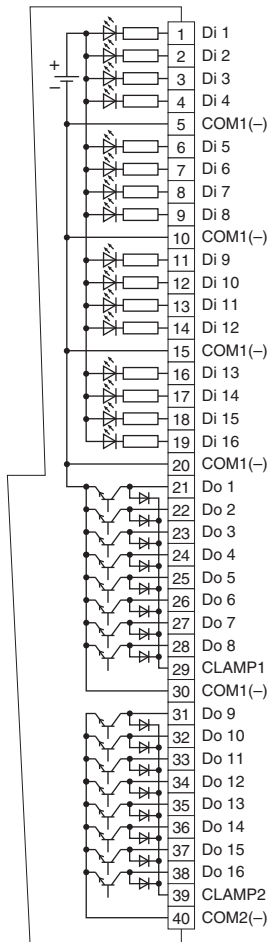

ANALOG INPUT UNIT

(Ai 32 points)

MODEL: DLA1-[1]G1[2]-[3][4]

ORDERING INFORMATION

- Code number: DLA1-[1]G1[2]-[3][4]
Specify a code from below for each of [1] through [4].
(e.g. DLA1-2G1A4-R/Q)
- Specify the specification for option code /Q
(e.g. /C01)

[1] TRANSMISSION MEDIA

- 1: Twisted-pair cable
- 2: Fiber optics cable
- 7: Twisted-pair - fiber optics (repeater incorporated)

[2] INPUT

Voltage

- A4:** 0 - 10 V DC (Input resistance 1 MΩ min.)
- A5:** 0 - 5 V DC (Input resistance 1 MΩ min.)
- A6:** 1 - 5 V DC (Input resistance 1 MΩ min.)

[3] POWER INPUT

AC Power

- K:** 85 - 132 V AC
(Operational voltage range 85 - 132 V, 47 - 66 Hz)
- L:** 170 - 264 V AC
(Operational voltage range 170 - 264 V, 47 - 66 Hz)

DC Power

- S:** 12 V DC
(Operational voltage range 12 V ±10 %, ripple 10 %p-p max.)
- R:** 24 V DC
(Operational voltage range 24 V ±10 %, ripple 10 %p-p max.)

[4] OPTIONS

- blank:** none
- /Q:** With options (specify the specification)

SPECIFICATIONS OF OPTION: Q

COATING (For the detail, refer to our web site.)

- /C01:** Silicone coating
- /C02:** Polyurethane coating
- /C03:** Rubber coating

GENERAL SPECIFICATIONS

Connection

- Input:** 40-pin connector terminal;
M3 screws (torque: 0.7 N·m)
- Applicable wire size:** 0.75 mm²
- Isolation:** Input to transmission to power
- Input CPU RUN indicator LED:** Red LED turns ON when the CPU operates normally.

INPUT SPECIFICATIONS

- Input:** DC voltage, 32 points
- Operational range:** -1.5 - +11.5 V DC
- Commons:** All negatives

PERFORMANCE

- Accuracy:** ±10 mV
- Temp. coefficient:** ±1.5 mV/°C (±0.9 mV/°F)
- Multi-transmission time:** 48 msec.
- Input read time:** 300 msec. per 32 points

EXTERNAL VIEW

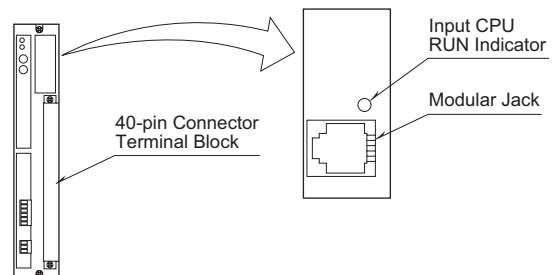

CONNECTION DIAGRAM

■ INPUT

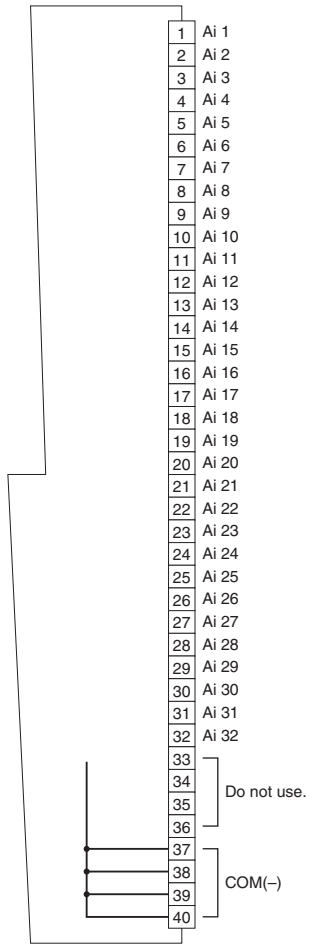

ANALOG OUTPUT UNIT

(Ao 32 points)

MODEL: DLA1-[1]M1[2]-[3][4]

ORDERING INFORMATION

- Code number: DLA1-[1]M1[2]-[3][4]
Specify a code from below for each of [1] through [4].
(e.g. DLA1-2M1B4-K/Q)
- Specify the specification for option code /Q
(e.g. /C01)

[1] TRANSMISSION MEDIA

- 1: Twisted-pair cable
- 2: Fiber optics cable
- 7: Twisted-pair - fiber optics (repeater incorporated)

[2] OUTPUT

Voltage

- B4:** 0 - 10 V DC (Load resistance 10 kΩ min.)
- B5:** 0 - 5 V DC (Load resistance 10 kΩ min.)
- B6:** 1 - 5 V DC (Load resistance 10 kΩ min.)

[3] POWER INPUT

AC Power

- K:** 85 - 132 V AC
(Operational voltage range 85 - 132 V, 47 - 66 Hz)
- L:** 170 - 264 V AC
(Operational voltage range 170 - 264 V, 47 - 66 Hz)

DC Power

- S:** 12 V DC
(Operational voltage range 12 V ±10 %, ripple 10 %p-p max.)
- R:** 24 V DC
(Operational voltage range 24 V ±10 %, ripple 10 %p-p max.)

[4] OPTIONS

- blank:** none
- /Q:** With options (specify the specification)

SPECIFICATIONS OF OPTION: Q

- COATING (For the detail, refer to our web site.)
- /C01:** Silicone coating
- /C02:** Polyurethane coating
- /C03:** Rubber coating

GENERAL SPECIFICATIONS

Connection

Output: 40-pin connector terminal; M3 screws
(torque 0.7 N·m)

Applicable wire size: 0.75 mm²

Isolation: Output to transmission to power

Output CPU RUN indicator LED: Red LED turns ON when the CPU operates normally.

OUTPUT SPECIFICATIONS

Commons: All negatives

Output: DC voltage, 32 points

Operational range: -1.5 - +11.5 V DC

PERFORMANCE

Accuracy: ±10 mV

Temp. coefficient: ±1.5 mV/°C (±0.9 mV/°F)

Output time: 200 msec. per 32 points

EXTERNAL VIEW

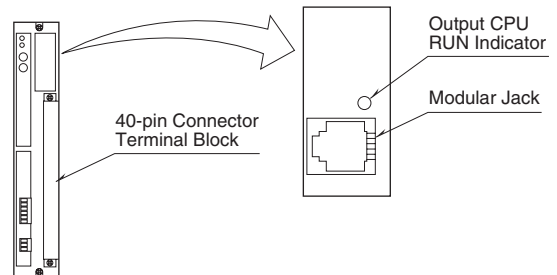

CONNECTION DIAGRAM

■ OUTPUT

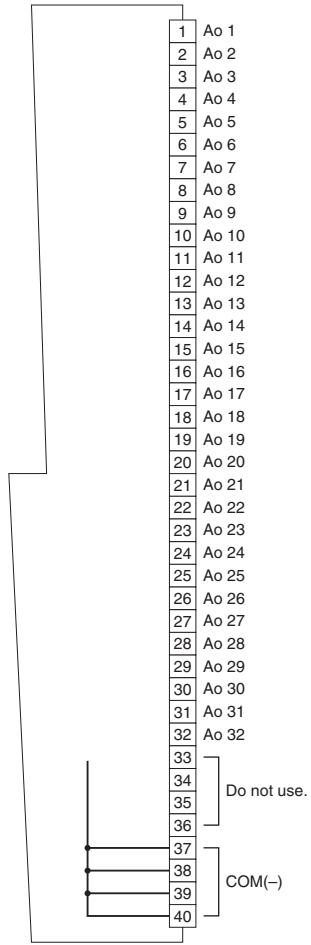

PULSE & ANALOG INPUT UNIT

(Pi 16 + Ai 16 points)

MODEL: DLA1-[1]P1[2]-[3][4]

ORDERING INFORMATION

- Code number: DLA1-[1]P1[2]-[3][4]
Specify a code from below for each of [1] through [4].
(e.g. DLA1-2P1A4-K/Q)
- Specify the specification for option code /Q
(e.g. /C01)

[1] TRANSMISSION MEDIA

- 1: Twisted-pair cable
- 2: Fiber optics cable
- 7: Twisted-pair - fiber optics (repeater incorporated)

[2] ANALOG INPUT

Voltage

A4: 0 - 10 V DC (Input resistance 1 MΩ min.)

A5: 0 - 5 V DC (Input resistance 1 MΩ min.)

A6: 1 - 5 V DC (Input resistance 1 MΩ min.)

[3] POWER INPUT

AC Power

K: 85 - 132 V AC

(Operational voltage range 85 - 132 V, 47 - 66 Hz)

L: 170 - 264 V AC

(Operational voltage range 170 - 264 V, 47 - 66 Hz)

DC Power

S: 12 V DC

(Operational voltage range 12 V ±10 %, ripple 10 %p-p max.)

R: 24 V DC

(Operational voltage range 24 V ±10 %, ripple 10 %p-p max.)

[4] OPTIONS

blank: none

/Q: With options (specify the specification)

SPECIFICATIONS OF OPTION: Q

COATING (For the detail, refer to our web site.)

/C01: Silicone coating

/C02: Polyurethane coating

/C03: Rubber coating

GENERAL SPECIFICATIONS

Connection

Input: 40-pin connector terminal;

M3 screws (torque: 0.7 N·m)

Applicable wire size: 0.75 mm²

Isolation: Input to transmission to power

Pulse input indicator LED: Red LEDs turn on when the respective input channels are closed.

Input CPU RUN indicator LED: Red LED turns ON when the CPU operates normally.

INPUT SPECIFICATIONS

■ **Analog Input:** DC voltage, 16 points

Operational range: -1.5 - +11.5V DC

Commons: All negatives

■ **Pulse Input:** Dry contact, 16 points

Commons: All negatives

Frequency range: 0 - 10 Hz

Pulse width requirement: 10 msec. min.

Scaling factor: 1

Sensing: Approx. 7.5 V DC @ 1 mA

ON/OFF level: ≤ 200 Ω for ON; ≥ 100 kΩ for OFF

Counter: 0 - 16383 (3FFF₍₁₆₎); reset to zero with overflow

PERFORMANCE

Accuracy: ±10 mV

Temp. coefficient: ±1.5 mV/°C (±0.9 mV/°F)

Multi-transmission time: 48 msec.

Input read time: 300 msec. per 32 points

CAUTION

When the power supply of DLA1-xP1 is temporarily turned off and turned ON again, totalized pulse output from DLA1-xU1 may be increased.

EXTERNAL VIEW

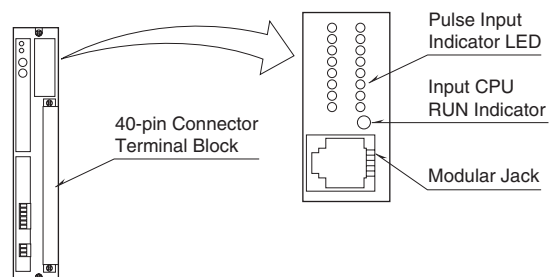

CONNECTION DIAGRAM

■ INPUT

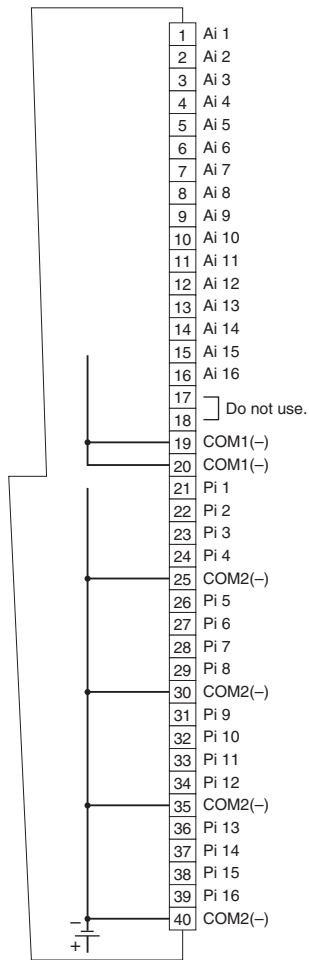

ANALOG I/O UNIT

(Ai 16 + Ao 16 points)

MODEL: DLA1-[1]R1[2][3]-[4][5]

ORDERING INFORMATION

- Code number: DLA1-[1]R1[2][3]-[4][5]
Specify a code from below for each of [1] through [5].
(e.g. DLA1-2R1A4B4-K/Q)
- Specify the specification for option code /Q
(e.g. /C01)

[1] TRANSMISSION MEDIA

- 1: Twisted-pair cable
- 2: Fiber optics cable
- 7: Twisted-pair - fiber optics (repeater incorporated)

[2] INPUT

Voltage

- A4:** 0 - 10 V DC (Input resistance 1 M Ω min.)
A5: 0 - 5 V DC (Input resistance 1 M Ω min.)
A6: 1 - 5 V DC (Input resistance 1 M Ω min.)

[3] OUTPUT

Voltage

- B4:** 0 - 10 V DC (Load resistance 10 k Ω min.)
B5: 0 - 5 V DC (Load resistance 10 k Ω min.)
B6: 1 - 5 V DC (Load resistance 10 k Ω min.)

[4] POWER INPUT

AC Power

- K:** 85 - 132 V AC
(Operational voltage range 85 - 132 V, 47 - 66 Hz)
L: 170 - 264 V AC
(Operational voltage range 170 - 264 V, 47 - 66 Hz)

DC Power

- S:** 12 V DC
(Operational voltage range 12 V \pm 10 %, ripple 10 %p-p max.)
R: 24 V DC
(Operational voltage range 24 V \pm 10 %, ripple 10 %p-p max.)

[5] OPTIONS

blank: none

/Q: With options (specify the specification)

SPECIFICATIONS OF OPTION: Q

COATING (For the detail, refer to our web site.)

- /C01:** Silicone coating
/C02: Polyurethane coating
/C03: Rubber coating

GENERAL SPECIFICATIONS

Connection:

I/O: 40-pin connector terminal; M3 screws
(torque 0.7 N·m)

Applicable wire size: 0.75 mm²

Isolation: I/O to transmission to power

I/O CPU RUN indicator LED: Red LED turns ON when the CPU operates normally.

INPUT SPECIFICATIONS

Input: DC voltage, 16 points

Operational range: -1.5 - +11.5 V DC

Commons: All negatives

OUTPUT SPECIFICATIONS

Output: DC voltage, 16 points

Operational range: -1.5 - +11.5 V DC

Commons: All negatives

PERFORMANCE

Accuracy: \pm 10 mV

Temp. coefficient: \pm 1.5 mV/ $^{\circ}$ C (\pm 0.9 mV/ $^{\circ}$ F)

Multi-transmission time: 24 msec.

Input read time: 300 msec. per 16 points

Output time: 200 msec. per 16 points

EXTERNAL VIEW

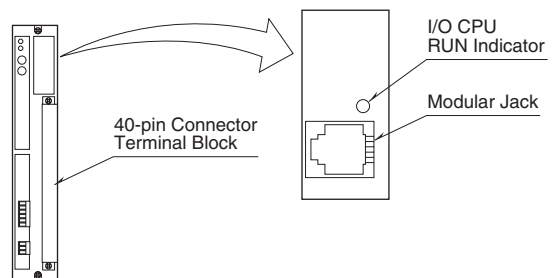

CONNECTION DIAGRAM

■ I/O

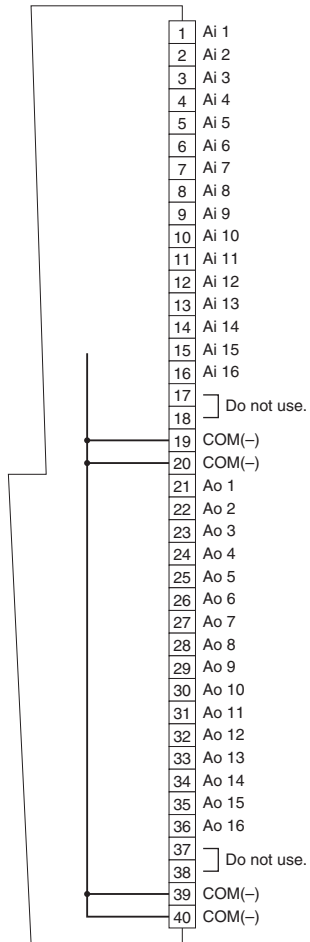

ANALOG & CONTACT I/O UNIT

(Ai 8 + Ao 8 + Di 8 + Do 8 points; relay contact output)

MODEL: DLA1-[1]S1[2][3]-[4][5]

ORDERING INFORMATION

- Code number: DLA1-[1]S1[2][3]-[4][5]
Specify a code from below for each of [1] through [5].
(e.g. DLA1-1S1A4B4-K/Q)
- Specify the specification for option code /Q
(e.g. /C01)

[1] TRANSMISSION MEDIA

- 1: Twisted-pair cable
- 2: Fiber optics cable
- 7: Twisted-pair - fiber optics (repeater incorporated)

[2] ANALOG INPUT

Voltage

- A4:** 0 - 10 V DC (Input resistance 1 MΩ min.)
- A5:** 0 - 5 V DC (Input resistance 1 MΩ min.)
- A6:** 1 - 5 V DC (Input resistance 1 MΩ min.)

[3] ANALOG OUTPUT

Voltage

- B4:** 0 - 10 V DC (Load resistance 10 kΩ min.)
- B5:** 0 - 5 V DC (Load resistance 10 kΩ min.)
- B6:** 1 - 5 V DC (Load resistance 10 kΩ min.)

[4] POWER INPUT

AC Power

- K:** 85 - 132 V AC
(Operational voltage range 85 - 132 V, 47 - 66 Hz)
- L:** 170 - 264 V AC
(Operational voltage range 170 - 264 V, 47 - 66 Hz)
- DC Power
- S:** 12 V DC
(Operational voltage range 12 V ±10 %, ripple 10 %p-p max.)
- R:** 24 V DC
(Operational voltage range 24 V ±10 %, ripple 10 %p-p max.)

[5] OPTIONS

blank: none

/Q: With options (specify the specification)

SPECIFICATIONS OF OPTION: Q

COATING (For the detail, refer to our web site.)

- /C01: Silicone coating
- /C02: Polyurethane coating
- /C03: Rubber coating

GENERAL SPECIFICATIONS

Connection:

I/O: 40-pin connector terminal; M3 screws
(torque 0.7 N·m)

Applicable wire size: 0.75 mm²

Isolation: I/O to transmission to power

Contact I/O indicator LED: Red LEDs turn on when the respective I/O channels are ON.

I/O CPU RUN indicator LED: Red LED turns ON when the CPU operates normally.

INPUT SPECIFICATIONS

- **Analog Input:** DC voltage, 8 points
Operational range: -1.5 - +11.5 V DC
Commons: All negatives
- **Contact Input:** Dry contact, 8 points
Commons: All negatives
- Sensing:** Approx. 15 V DC @ 3 mA
- ON/OFF level:** ≤ 200 Ω for ON; ≥ 100 kΩ for OFF

OUTPUT SPECIFICATIONS

- **ANALOG OUTPUT:** DC voltage, 8 points
Operational range: -1.5 - +11.5 V DC
Commons: All negatives
- **CONTACT OUTPUT:** Relay contact, 8 points
Commons: Per 4 points; common current 4A max.
Contact rating: 120 V AC @ 1 A (cos φ = 1)
30 V DC @ 1 A (resistive load)
Maximum switching voltage: 120 V AC or 30 V DC
Maximum switching power: 120 VA or 30 W
Minimum load: 5 V DC @ 10 mA
Mechanical life: 5 × 10⁷ cycles
For maximum relay life with inductive loads, external protection is recommended.

PERFORMANCE

Accuracy: ± 10 mV

Temp. coefficient: ± 1.5 mV/ $^{\circ}\text{C}$ (± 0.9 mV/ $^{\circ}\text{F}$)

Multi-transmission time: 12 msec.

Input read time

Analog: 300 msec. per 8 points

Contact: 3 msec. per 8 points

Output time

Analog: 200 msec. per 8 points

Contact: 8 msec. per 8 points for OFF to ON

3 msec. per 8 points for ON to OFF

EXTERNAL VIEW

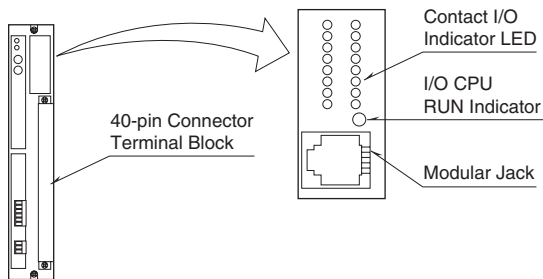

CONNECTION DIAGRAM

■ I/O

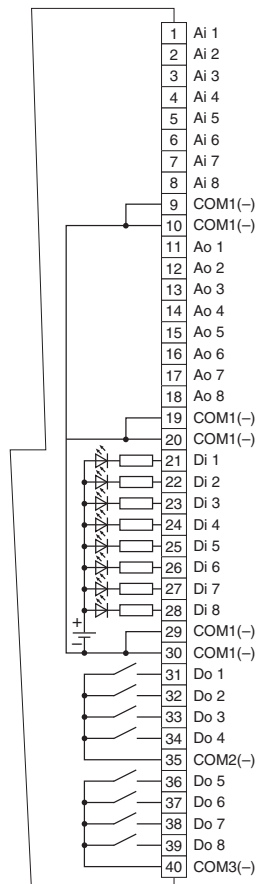

PULSE & ANALOG OUTPUT UNIT

(Po 16 + Ao 16 points)

MODEL: DLA1-[1]U1[2]-[3][4]

ORDERING INFORMATION

- Code number: DLA1-[1]U1[2]-[3][4]
Specify a code from below for each of [1] through [4].
(e.g. DLA1-2U1B4-K/Q)
 - Specify the specification for option code /Q
(e.g. /C01)
- Use Ordering Information Sheet (No. ESU-6510-U1) to describe your system configuration in order to calculate appropriate "Loss of Communication Check Time."

[1] TRANSMISSION MEDIA

- 1: Twisted-pair cable
- 2: Fiber optics cable
- 7: Twisted-pair - fiber optics (repeater incorporated)

[2] ANALOG OUTPUT

Voltage

- B4:** 0 - 10 V DC (Load resistance 10 kΩ min.)
B5: 0 - 5 V DC (Load resistance 10 kΩ min.)
B6: 1 - 5 V DC (Load resistance 10 kΩ min.)

[3] POWER INPUT

AC Power

- K:** 85 - 132 V AC
(Operational voltage range 85 - 132 V, 47 - 66 Hz)
- L:** 170 - 264 V AC
(Operational voltage range 170 - 264 V, 47 - 66 Hz)
- DC Power
- S:** 12 V DC
(Operational voltage range 12 V ±10 %, ripple 10 %p-p max.)
- R:** 24 V DC
(Operational voltage range 24 V ±10 %, ripple 10 %p-p max.)

[4] OPTIONS

- blank:** none
/Q: With options (specify the specification)

SPECIFICATIONS OF OPTION: Q

- COATING (For the detail, refer to our web site.)
/C01: Silicone coating
/C02: Polyurethane coating
/C03: Rubber coating

GENERAL SPECIFICATIONS

Connection

Output: 40-pin connector terminal; M3 screws
(torque 0.7 N·m)

Applicable wire size: 0.75 mm²

Isolation: Output to transmission to power

Pulse output indicator LED: Red LEDs turn on when the respective output channels are closed.

Output CPU RUN indicator LED: Red LED turns ON when the CPU operates normally.

OUTPUT SPECIFICATIONS

- **Analog Output:** DC voltage, 16 points
- Operational range:** -1.5 - +11.5 V DC
- Commons:** All negatives
- **Pulse Output:** Open collector (Darlington), 16 points
- Commons:** All negatives
- Contact rating:** 30 V DC @ 100 mA (resistive load)
- Saturation voltage:** 1.6 V DC
- Maximum frequency:** 10 Hz
- Pulse width:** Duty ratio 50 %

PERFORMANCE

- Accuracy:** ±10 mV
Temp. coefficient: ±1.5 mV/°C (±0.9 mV/°F)
Multi-transmission time: 48 msec.
Output time: 200 msec. per 32 points

EXTERNAL VIEW

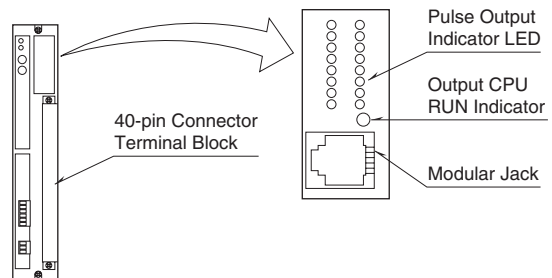

CONNECTION DIAGRAM

■ OUTPUT

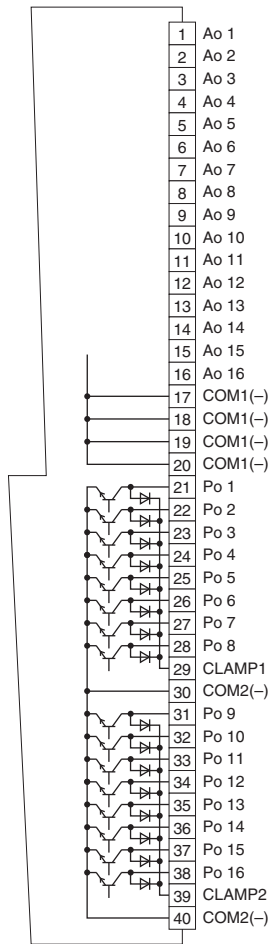

Specifications are subject to change without notice.