

## Space-saving Plug-in Signal Conditioners H-UNIT

### DC/FREQUENCY CONVERTER

#### Functions & Features

- Providing a pulse rate output in proportion to DC input signal
- High-density mounting

#### Typical Applications

- Totalizing applications in combination with a counter

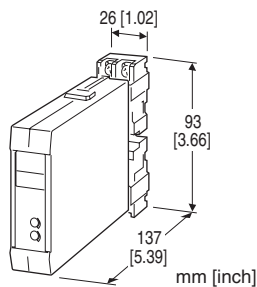

## MODEL: HAP-[1][2]-R[3]

### ORDERING INFORMATION

- Code number: HAP-[1][2]-R[3]
- Specify a code from below for each of [1] through [3].  
(e.g. HAP-61-R/Q)
- Special input range (For codes Z & 0)
  - Output frequency range (e.g. 0 - 500 Hz)
  - Specify the specification for option code /Q  
(e.g. /C01/S01)

### [1] INPUT

#### Current

- A:** 4 - 20 mA DC (Input resistance 250 Ω)
- D:** 0 - 20 mA DC (Input resistance 50 Ω)
- G:** 0 - 1 mA DC (Input resistance 1000 Ω)
- H:** 10 - 50 mA DC (Input resistance 100 Ω)
- Z:** Specify current (See INPUT SPECIFICATIONS)  
( 0 % input must be 0 mA.)

#### Voltage

- 3:** 0 - 1 V DC (Input resistance 1 MΩ min.)
- 4:** 0 - 10 V DC (Input resistance 1 MΩ min.)
- 5:** 0 - 5 V DC (Input resistance 1 MΩ min.)
- 6:** 1 - 5 V DC (Input resistance 1 MΩ min.)
- 0:** Specify voltage (See INPUT SPECIFICATIONS)  
( 0 % input must be 0 V.)

### [2] OUTPUT

- 1:** Open collector (max. 1 kHz)
- 2:** 5 V pulse (max. 1 kHz)
- 5:** Photo MOSFET relay pulse (max. 30 Hz)

### POWER INPUT

#### DC Power

- R:** 24 V DC  
(Operational voltage range 24 V ±10 %, ripple 10 %p-p max.)

### [3] OPTIONS

- blank:** none
- /Q:** With options (specify the specification)

### SPECIFICATIONS OF OPTION: Q (multiple selections)

#### COATING (For the detail, refer to our web site.)

- /C01:** Silicone coating
- /C02:** Polyurethane coating
- /C03:** Rubber coating

#### TERMINAL SCREW MATERIAL

- /S01:** Stainless steel

### GENERAL SPECIFICATIONS

- Construction:** Plug-in
- Connection:** M3.5 screw terminals (torque 0.8 N·m)
- Screw terminal:** Nickel-plated steel (standard) or stainless steel
- Housing material:** Flame-resistant resin (black)
- Isolation:** Input to output to power
- Zero adjustment:** 0 - 5 % (front)
- Span adjustment:** 95 to 105 % (front)

### INPUT SPECIFICATIONS

- **DC Current:**  
Shunt resistor attached to the input terminals (0.5 W)  
Specify input resistance value for code Z.
- **DC Voltage:** 0 - 300V DC
- Minimum span:** 1V
- Input resistance:** 1 MΩ min.

## OUTPUT SPECIFICATIONS

■ **Open Collector:** 30 V DC @100 mA (resistive load)

Frequency range: 0 - 10 pulses/hour through 1 kHz

Saturation voltage: 0.6 V DC

■ **5 V Pulse**

Frequency range: 0 - 10 pulses/hour through 1 kHz

Hi level: 3.0 - 5.5 V

Lo level: ≤ 0.5 V

Load resistance: 250 Ω min.

■ **Photo MOSFET Relay Pulse**

Frequency range: 0 - 10 pulses/hour through 30 Hz

Timer: Limits ON time within 75 ±25 msec.

Rating: 132 V AC @ 200 mA (cos φ = 1)

30 V DC @ 200 mA (resistive load)

ON resistance: ≤ 2 Ω

Weight: 190 g (0.42 lb)

## PERFORMANCE in percentage of span

Accuracy: ±0.1 %

Temp. coefficient: ±0.015 %/°C (±0.008 %/°F)

Response time: ≤ 3 sec. (0 - 90 %)

Line voltage effect: ±0.1 % over voltage range

Insulation resistance: ≥ 100 MΩ with 500 V DC

Dielectric strength: 500 V AC @ 1 minute

(input to output to power)

1500 V AC @ 1 minute (input or output or power to ground)

## OUTPUT PULSE WIDTH

■ **Frequency less than 500 Hz at 100% input**

→ Duty ratio 20% (See the figure below)

• **Open Collector**

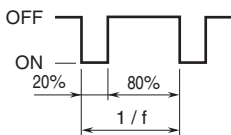

• **Voltage Pulse**

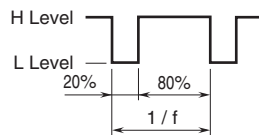

■ **Frequency greater than 500 Hz at 100% input**

→ See the figure and equation below.

• **Open Collector**

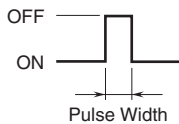

• **Voltage Pulse**

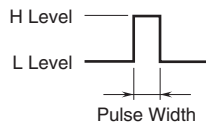

$$\text{Pulse Width [millisec.]} = \frac{1}{2.09 \times 100\% \text{ Frequency [kHz]}}$$

■ **Photo MOSFET Relay Pulse**

→ See the figure below. ON pulse width is limited within 75 ±25 msec. when the output frequency gets low (below 2 to 4 Hz).

• **Photo MOSFET Relay Pulse**

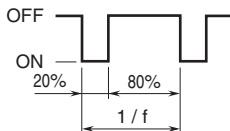

## INSTALLATION

Current consumption: Approx. 60 mA

Operating temperature: -5 to +55°C (23 to 131°F)

Operating humidity: 30 to 90 %RH (non-condensing)

Mounting: Surface or DIN rail; Standard Rack Mounting

Frame BX-16H available

## EXTERNAL DIMENSIONS unit: mm [inch]

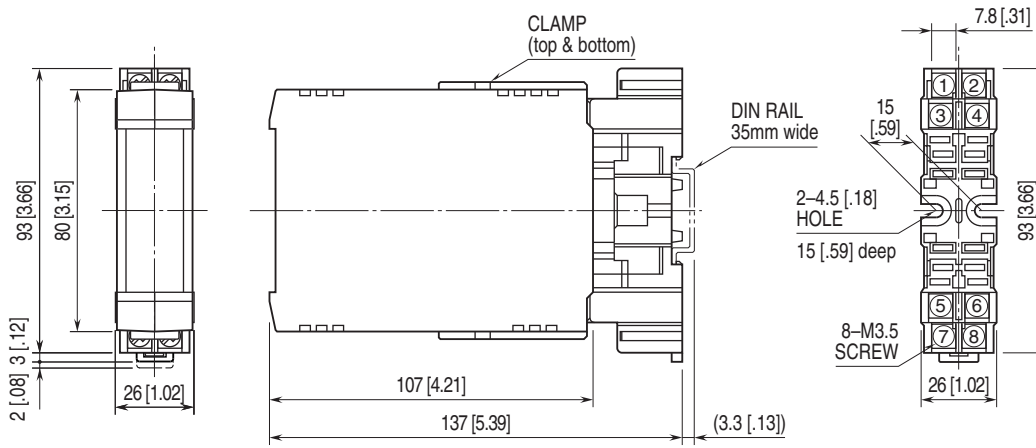

•When mounting, no extra space is needed between units.

## TERMINAL ASSIGNMENTS unit: mm [inch]

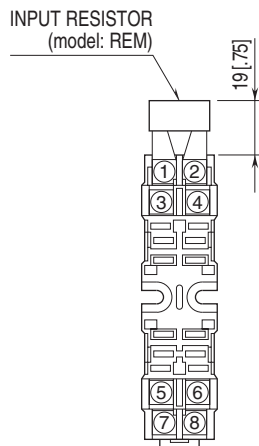

Input shunt resistor attached for current input.

## SCHEMATIC CIRCUITRY & CONNECTION DIAGRAM

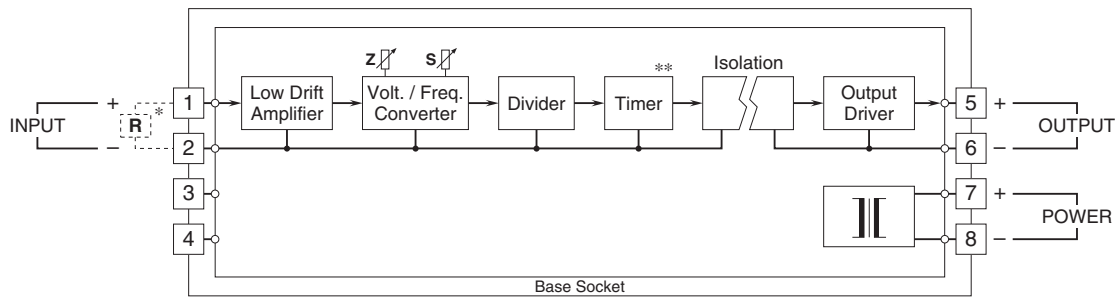

- \* Input shunt resistor attached for current input.
- \*\* Photo MOSFET relay pulse only.

### Output Connection Examples

#### ■ Open Collector

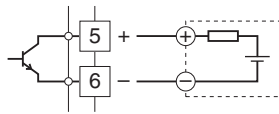

#### ■ Voltage Pulse

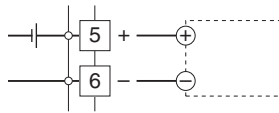

#### ■ Photo MOSFET Relay Pulse

##### • AC Powered

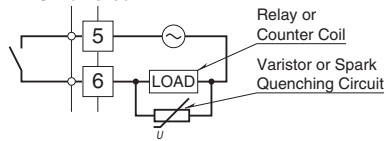

##### • DC Powered

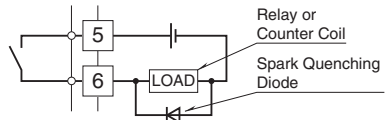

Specifications are subject to change without notice.