

Tower Light Series

DISCRETE INPUT TOWER LIGHT

(super-small size, 50 mm dia., 1 - 5 layers, pole mounting)

Functions & Features

- Discrete input tower light
- Lighting is controllable with PLC.

■ CIRCULAR BASE MOUNT TYPE ■ L-SHAPED MOUNT TYPE

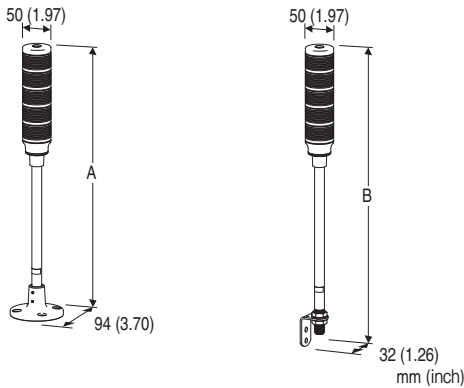

Lamp Layers	A	B
1	362.5 (14.27)	395.5 (15.57)
2	394.5 (15.53)	427.5 (16.83)
3	426.5 (16.79)	459.5 (18.09)
4	458.5 (18.05)	491.5 (19.35)
5	490.5 (19.31)	523.5 (20.61)



MODEL: IT50SA3-[1][2][3][4][5][6][7]-AR[8]

ORDERING INFORMATION

- Code number: IT50SA3-[1][2][3][4][5][6][7]-AR[8]
Specify a code from below for each of [1] through [8].
(e.g. IT50SA3-5RYGBWC-AR/Q)
- Specify the specification for option code /Q
(e.g. /C01)

[1] LAMP LAYERS

- 1: 1 layer
- 2: 2 layers
- 3: 3 layers
- 4: 4 layers
- 5: 5 layers

[2] LAMP 1 COLOR

(1st layer from the top)

- R: Red
- Y: Amber
- G: Green
- B: Blue
- W: White

[3] LAMP 2 COLOR

(2nd layer from the top)

- R: Red
- Y: Amber
- G: Green
- B: Blue
- W: White

N: None (not available when Lamp Layers selected are 2 - 5)

[4] LAMP 3 COLOR

(3rd layer from the top)

- R: Red
- Y: Amber
- G: Green
- B: Blue
- W: White

N: None (not available when Lamp Layers selected are 3 - 5)

[5] LAMP 4 COLOR

(4th layer from the top)

- R: Red
- Y: Amber
- G: Green
- B: Blue
- W: White

N: None (not available when Lamp Layers selected are 4 - 5)

[6] LAMP 5 COLOR

(5th layer from the top.)

- R: Red
- Y: Amber
- G: Green
- B: Blue
- W: White

N: None (not available when Lamp Layers selected are 5)

* The selection of the same color for more than one layer is not available.

* Select "None" option for the layers other than the selected.

[7] MOUNTING

C: Circular base mount
L: L-shaped mount

POWER INPUT

Universal

AR: 24 V AC (Operational voltage range 24 V \pm 10 %, 47 - 66 Hz)
24 V DC (Operational voltage range 24 V \pm 10 %, ripple 10 %p-p max.)

[8] OPTIONS

blank: none

/Q: With options (specify the specification)

SPECIFICATIONS OF OPTION: Q

COATING (For the detail, refer to our web site.)

/C01: Silicone coating

/C02: Polyurethane coating

/C03: Rubber coating

GENERAL SPECIFICATIONS

Degree of protection:

- Circular base mount: IP65
- L-shaped mount: IP13

(Vertical mounting only, bottom excluded)

Connection: UL1007 AWG22

Housing material: Flame-resistant resin

Lens: Flame-resistant resin (transparent)

Lamp: Red, amber, green, blue and white LEDs

INPUT SPECIFICATIONS

Discrete Input: Dry contact, open collector PNP or NPN

Rated input voltage:

24 V AC (Operational voltage range 24 V \pm 10 %, 47 - 66 Hz)

24 V DC (Operational voltage range 24 V \pm 10 %, ripple 10 %p-p max.)

Input current: \leq 14 mA/point (@24 V DC)

Input resistance: Approx. 1000 Ω

INSTALLATION

Power consumption

•AC: \leq 2.4 VA 24 V AC

•DC: \leq 2.2 W 24 V DC

Operating temperature: -10 to +55°C (14 to 131°F)

Operating humidity: 30 to 90 %RH (non-condensing)

Atmosphere: No corrosive gas

Mounting: Pole mounting (in vertical direction only)

Weight

Circular base mount: 700 g (1.54 lb)

L-shaped mount: 650 g (1.43 lb)

STANDARDS & APPROVALS

EU conformity:

EMC Directive

EN 60947-5-1

RoHS Directive

EXTERNAL VIEW

■ CIRCULAR BASE MOUNT TYPE

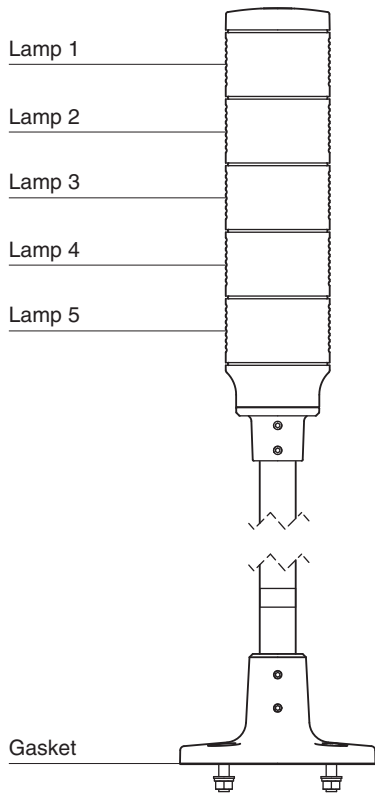

■ L-SHAPED MOUNT TYPE

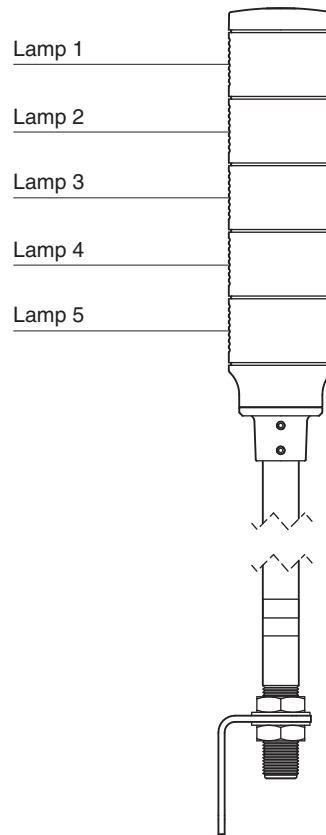

EXTERNAL DIMENSIONS unit: mm

■ CIRCULAR BASE MOUNT TYPE

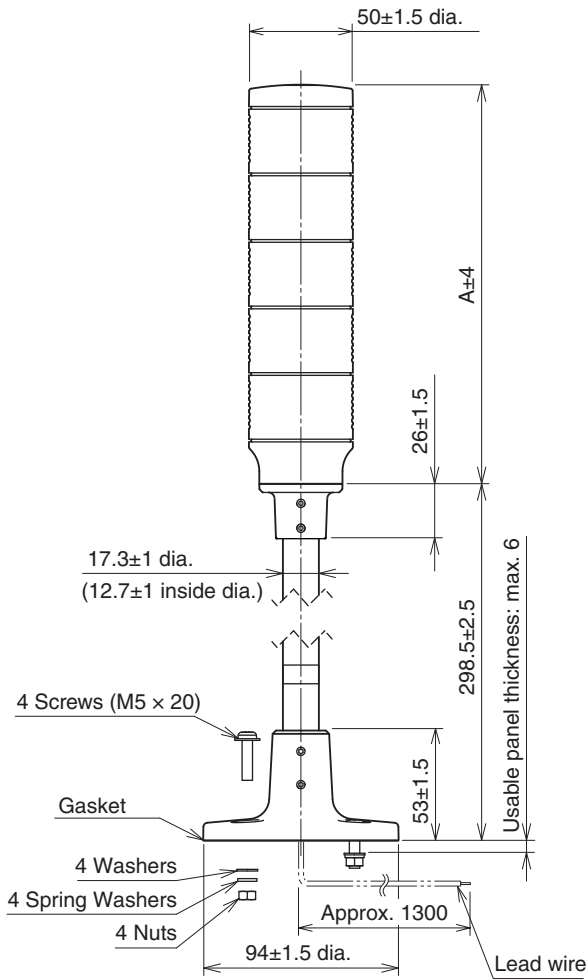

Lamp Layers	A
1	64
2	96
3	128
4	160
5	192

■ L-SHAPED MOUNT TYPE

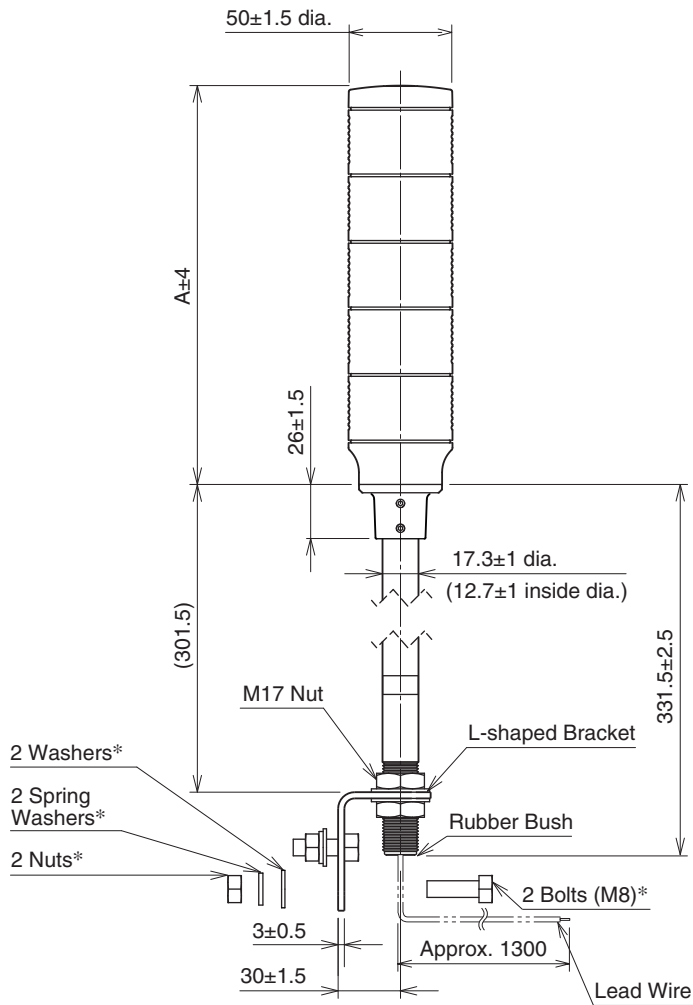

Lamp Layers	A
1	64
2	96
3	128
4	160
5	192

* Not included with product package.

MOUNTING REQUIREMENTS unit: mm [inch]

■ CIRCULAR BASE MOUNT TYPE

■ L-SHAPED MOUNT TYPE

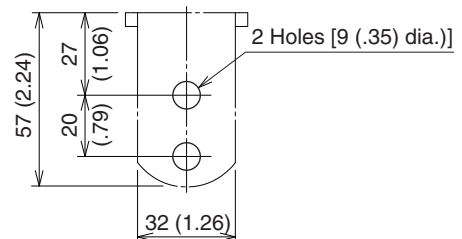
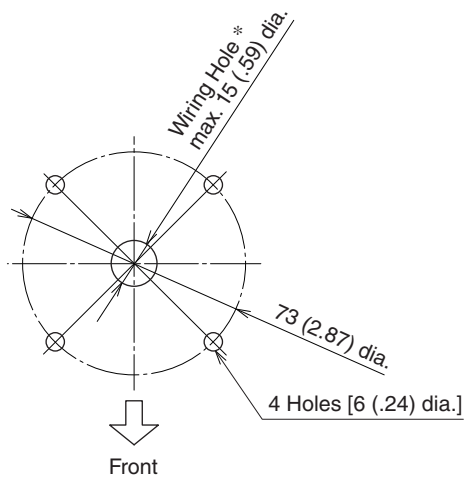

* Protect wires to prevent scratching them on edges.
Determine the hole diameter according to the size of the wires and connectors.

SCHEMATIC CIRCUITRY & CONNECTION DIAGRAM

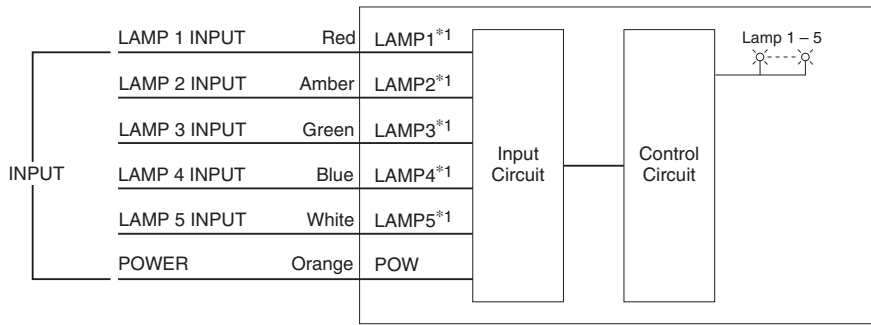

*1. Example of 5 layers in order: red, amber, green, blue and white.
Lamp and wire colors are the same.

■ WIRING TO INPUT SIGNAL

• Contact input e.g.

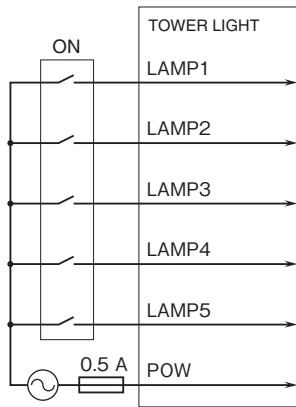

• NPN input e.g.

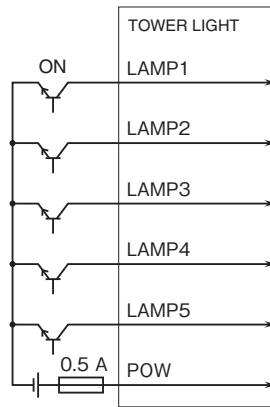

• PNP input e.g.

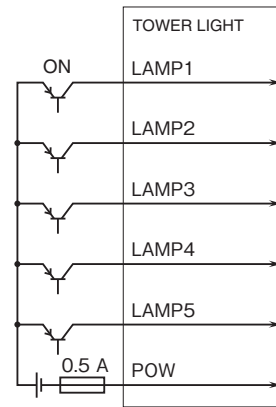

Note 1: NPN input and PNP input are available only for 24 V DC.



Specifications are subject to change without notice.