

## Plug-in Signal Conditioners M-UNIT

### FREQUENCY TRANSMITTER

(field-programmable; built-in excitation)

#### Functions & Features

- Converts the output from a pulse-type transducer into a standard process signal
- Built-in excitation
- Field-selectable input type and range: Open collector, mechanical contact, voltage pulse or two-wire current pulse
- Isolation up to 2000 V AC
- High-density mounting

#### Typical Applications

- Positive displacement flowmeters, turbine flowmeters and vortex flowmeters
- Measuring rotation speed of a machine generating dry contact signals

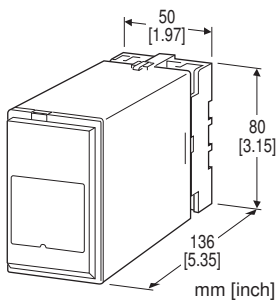

### MODEL: JPA2-[1][2]-[3][4]

#### ORDERING INFORMATION

- Code number: JPA2-[1][2]-[3][4]
- Specify a code from below for each of [1] through [4]. (e.g. JPA2-76-K/Q)
- Special output range (For codes Z & 0)
- Use Ordering Information Sheet (No. ESU-1572). Factory setting (indicated below) will be used if not otherwise specified.
- Specify the specification for option code /Q (e.g. /C01/S01)

#### Factory Setting

Input type	Open collector
Pulse amplitude	----
Pulse sensing	DC coupled
Noise filter	Low
Detecting level	2V *1
Frequency range	0 – 1 kHz
Input zero frequency	0 Hz
Input span frequency	1 kHz
Low-end cutout	-15%
Low-end cutout deadband	1%
Alarm setpoint	100%
Alarm deadband	1.00%
Alarm mode	High alarm
Non-uniform pulse compensation	1 (no compensation)
Linearization	Without

\*1. Detecting voltage in the internal circuit

### INPUT - Field-selectable

- Open collector
- Mechanical contact
- Voltage pulse
- Two-wire current pulse

### [1] EXCITATION

- 1: 5 V DC @ 120 mA
- 4: 12 V DC @ 60 mA
- 7: 24 V DC @ 25 mA

### [2] OUTPUT

Current

- A: 4 – 20 mA DC (Load resistance 750 Ω max.)
- B: 2 – 10 mA DC (Load resistance 1500 Ω max.)
- C: 1 – 5 mA DC (Load resistance 3000 Ω max.)
- D: 0 – 20 mA DC (Load resistance 750 Ω max.)
- E: 0 – 16 mA DC (Load resistance 900 Ω max.)
- F: 0 – 10 mA DC (Load resistance 1500 Ω max.)
- G: 0 – 1 mA DC (Load resistance 15 kΩ max.)
- Z: Specify current (See OUTPUT SPECIFICATIONS)

Voltage

- 1: 0 – 10 mV DC (Load resistance 10 kΩ min.)
- 2: 0 – 100 mV DC (Load resistance 100 kΩ min.)
- 3: 0 – 1 V DC (Load resistance 100 Ω min.)
- 4: 0 – 10 V DC (Load resistance 1000 Ω min.)
- 5: 0 – 5 V DC (Load resistance 500 Ω min.)
- 6: 1 – 5 V DC (Load resistance 500 Ω min.)
- 4W: -10 – +10 V DC (Load resistance 2000 Ω min.)
- 5W: -5 – +5 V DC (Load resistance 1000 Ω min.)
- 0: Specify voltage (See OUTPUT SPECIFICATIONS)

## [3] POWER INPUT

AC Power  
**K:** 85 - 132 V AC  
 DC Power  
**S:** 12 V DC  
**R:** 24 V DC  
**V:** 48 V DC  
**P:** 110 V DC

## [4] OPTIONS

**blank:** none  
**/Q:** With options (specify the specification)

### SPECIFICATIONS OF OPTION: Q (multiple selections)

COATING (For the detail, refer to our web site.)  
**/C01:** Silicone coating  
**/C02:** Polyurethane coating  
**/C03:** Rubber coating  
 TERMINAL SCREW MATERIAL  
**/S01:** Stainless steel

### RELATED PRODUCTS

- Programming Unit (model: PU-2x)
- PC configurator software (model: JXCON)

Downloadable at our web site.  
 A dedicated cable is required to connect the module to the PC. Please refer to the internet software download site or the users manual for the PC configurator for applicable cable types.

### GENERAL SPECIFICATIONS

**Construction:** Plug-in  
**Connection:** M3.5 screw terminals  
**Screw terminal:** Chromated steel (standard) or stainless steel  
**Housing material:** Flame-resistant resin (black)  
**Isolation:** Input to DC output to alarm output to power  
**Overrange output:** Approx. -15 to +115 % at 1 - 5 V  
**Zero adjustment:** -5 to +5 % (front)  
**Span adjustment:** 95 to 105 % (front)  
**Alarm mode:** High or Low  
**Alarm setpoint:** -15 - +115 %  
**Alarm deadband:** 0 - 20 %  
**Linearization:** Max. 16 points  
**Input monitor LED:** Red LED blinks according to the input.  
**Excitation adjustment:** 5 - 24 V DC  
**Software programming:** Programming Unit (model: PU-2x); (Refer to the users manual of JXCON for the adjustments configurable with JXCON)  
 • Input frequency range

- Zero and span
  - Low-end cutout
  - Linearization
  - Alarm setpoint
  - Output fine adjustment
  - Averaging non-uniform pulses
  - Others
- Adjustments:** With DIP and Rotary switches.
- Input Type
  - Pulse Sensing
  - Noise Filter
  - Detecting level

(Refer to the instruction manual for details)

**Modular jack:** Connecting the PU-2x

**Low-end cutout:** -15 - +115 % adjustable  
 (% of the input range determined by the input zero and span frequencies. This unit outputs 0 % for the input below the setting. When the input zero frequency is set to 0 Hz, the low-end cutout setting below 0 % is not valid.)

### INPUT SPECIFICATIONS

**Excitation:** Shortcircuit protection; approx. 440 mA (max.) at shortcircuit

**Frequency ranges:** 0 - 0.01 Hz through 100 kHz (up to 10 Hz for mechanical contact)

**Minimum pulse width time requirement:** 5  $\mu$ sec.; 50 msec. for mechanical contact (for both ON and OFF)

**Minimum span:** 10 % of the selected frequency range

#### ■ Open Collector & Mechanical Contact

##### Input requirements

(Excitation: Sensing: OFF: ON)

5 V: Approx. 4 V / 1.0 mA:  $\geq 200 \text{ k}\Omega$ :  $\leq 200 \Omega$

12 V: Approx. 9 V / 2.3 mA:  $\geq 200 \text{ k}\Omega$ :  $\leq 200 \Omega$

24 V: Approx. 16 V / 4.7 mA:  $\geq 200 \text{ k}\Omega$ :  $\leq 200 \Omega$

**Detecting level:** 2 V (Detecting voltage in the internal circuit.)

**Detecting pulse edge:** OFF (input monitor LED ON) to ON (input monitor LED OFF)

#### ■ Voltage Pulse

**Waveform:** Square or sine

**Input impedance:** 10 k $\Omega$  min.

**Pulse amplitude:** 0.1 - 100 Vp-p

**Max. voltage between input terminals:** 50 V

**Detecting level:** 0 - 5 V (factory setting: 2 V)

(Detecting voltage in the internal circuit.)

**Detecting pulse state:** A pulse rise detected when the input voltage goes above the detecting level (input monitor LED ON); a pulse sink detected when it goes below the level (input monitor LED OFF).

#### ■ Two-wire Current Pulse

**Input resistance:** Receiving resistor 100  $\Omega$

**Input range:** 0 - 25 mA

**Minimum pulse amplitude:** 10 mA

**Detecting level:** 0 - 5 V

(Detecting voltage in the internal circuit.)

**Detecting pulse state:** The input resistor (100 Ω) converts the current signal (0 - 25 mA) into 0 - 2.5 V. A pulse rise detected when the voltage goes above the detecting level (input monitor LED ON); a pulse sink detected when it goes below the level (input monitor LED OFF).

■ **Voltage pulse waveform**

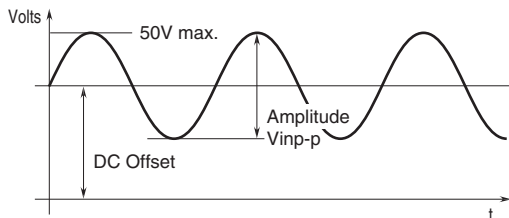

## OUTPUT SPECIFICATIONS

■ **DC Current:** 0 - 20 mA DC

**Minimum span:** 1 mA

**Offset:** Max. 1.5 times span

**Load resistance:** Output drive 15 V max.

■ **DC Voltage:** -10 - +12 V DC

**Minimum span:** 5 mV

**Offset:** Max. 1.5 times span

**Load resistance:** Output drive 10 mA max.; 5 mA for negative voltage output; at  $\geq 0.5$  V

■ **Alarm Output:** Relay contact

**Rated load:** 125 V AC @ 0.5 A ( $\cos \phi = 1$ )

30 V DC @ 0.5 A (resistive load)

**Maximum switching voltage:** 250 V AC or 125 V DC

**Maximum switching power:** 62.5 VA or 60 W

**Minimum load:** 10 mV DC @ 1 mA

**Mechanical life:**  $5 \times 10^7$  cycles (300 cycles/minute)

For maximum relay life with inductive loads, external protection is recommended.

## INSTALLATION

**Power input**

• **AC:** Operational voltage range 85 - 132 V,

47 - 66 Hz, approx. 6 VA

• **DC:** Operational voltage range: Rating  $\pm 10$  %, or 85 - 150 V for 110 V rating; ripple 10 %p-p max.; Approx. 3.3 W (130 mA at 24 V)

**Operating temperature:** -5 to +60°C (23 to 140°F)

**Operating humidity:** 30 to 90 %RH (non-condensing)

**Mounting:** Surface or DIN rail

**Weight:** 350 g (0.77 lb)

## PERFORMANCE in percentage of span

**Accuracy:** Input accuracy + output accuracy

**Input accuracy:**  $\pm 0.05\%$  of the selected freq. range

Inversely proportional to the input span.

[Example] Open collector input, 0 - 50 kHz

Selected Freq. Range 100 kHz  $\div$  Input Span 50 kHz  $\times$

Accuracy 0.05 % + Output Accuracy 0.05 % =  $\pm 0.15$  %

**Output accuracy:**  $\pm 0.05$  % of the output range

**Alarm setpoint accuracy:**  $\pm 0.1$  %

**Temp. coefficient:**  $\pm 0.015$  %/°C ( $\pm 0.008$  %/°F)

**Response time:** 0.5 sec. + 1 pulse cycle (0 - 90 %)

**Line voltage effect:**  $\pm 0.1$  % over voltage range

**Insulation resistance:**  $\geq 100$  MΩ with 500 V DC

**Dielectric strength:**

2000 V AC @ 1 minute (input to output to power)

1500 V AC @ 1 minute (input or output or power to alarm output)

2000 V AC @ 1 minute (circuit to ground)

**EXTERNAL VIEW**

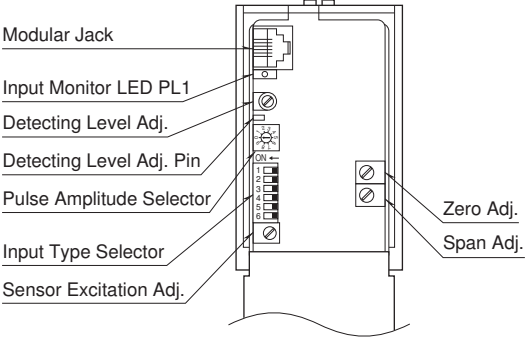

Refer to the instruction manual for detailed procedures.

**EXTERNAL DIMENSIONS & TERMINAL ASSIGNMENTS unit: mm [inch]**

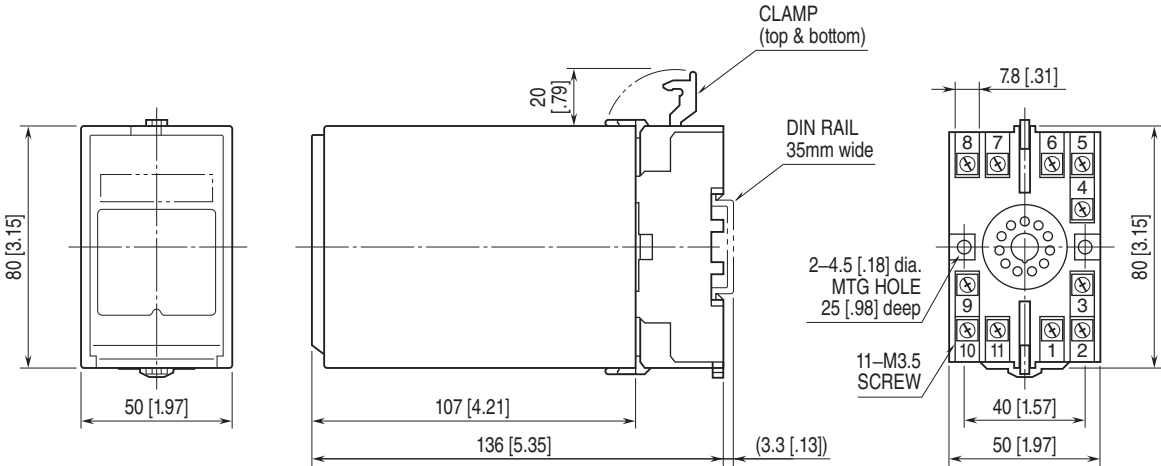

• When mounting, no extra space is needed between units.

**SCHEMATIC CIRCUITRY & CONNECTION DIAGRAM**

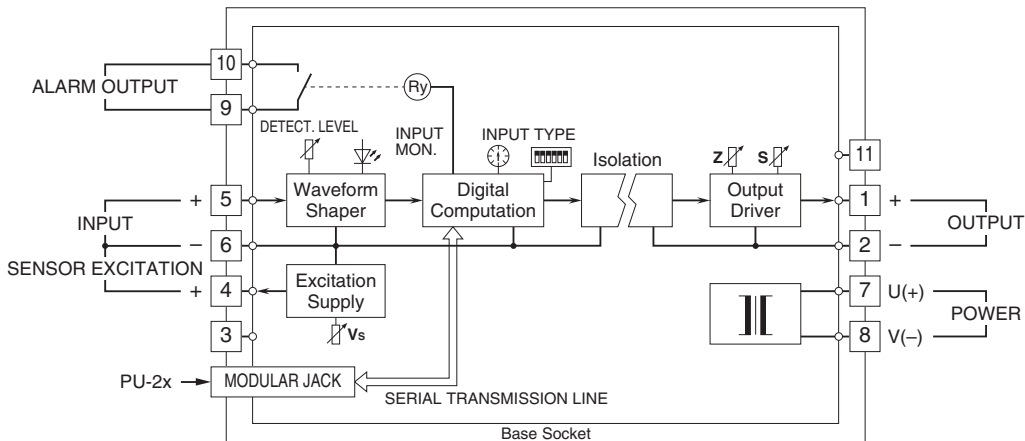

**Input Connection Examples**

■ **Open Collector or Mechanical Contact**

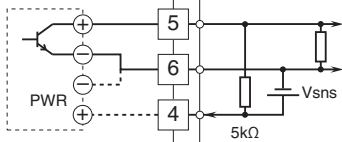

■ **2-Wire Current Pulse**  
• **Built-in Excitation**

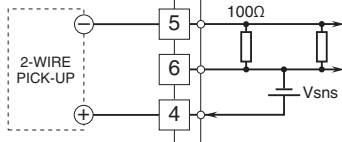

■ **Voltage Pulse**

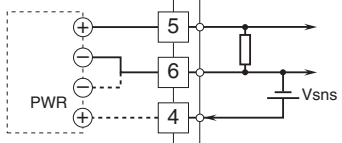

• **External DC Supply**

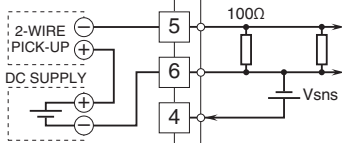

Specifications are subject to change without notice.